

User's Manual

MX-30

3-CHANNEL DJ MIXER

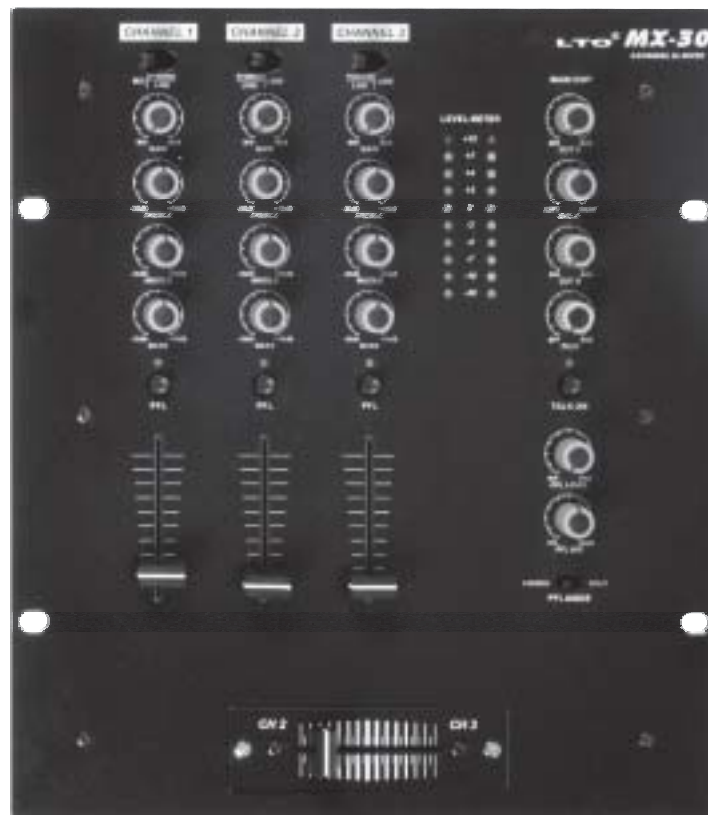

www.altoproaudio.com
Version 1.0 December 2003

— English —

SAFETY RELATED SYMBOLS



This symbol, wherever used, alerts you to the presence of un-insulated and dangerous voltages within the product enclosure. These are voltages that may be sufficient to constitute the risk of electric shock or death.



This symbol, wherever used, alerts you to important operating and maintenance instructions. Please read.



Protective Ground Terminal



AC mains (Alternating Current)



Hazardous Live Terminal

ON: Denotes the product is turned on.

OFF: Denotes the product is turned off.

WARNING

Describes precautions that should be observed to prevent the possibility of death or injury to the user.

CAUTION

Describes precautions that should be observed to prevent damage to the product.

WARNING

• Power Supply

Ensure that the mains source voltage (AC outlet) matches the voltage rating of the product. Failure to do so could result in damage to the product and possibly the user.

Unplug the product before electrical storms occur and when unused for long periods of time to reduce the risk of electric shock or fire.

• External Connection

Always use proper ready-made insulated mains cabling (power cord). Failure to do so could result in shock/death or fire. If in doubt, seek advice from a registered electrician.

• Do Not Remove Any Covers

Within the product are areas where high voltages may present. To reduce the risk of electric shock do not remove any covers unless the AC mains power cord is removed.

Covers should be removed by qualified service personnel only.

No user serviceable parts inside.

• Fuse

To prevent fire and damage to the product, use only

the recommended fuse type as indicated in this manual. Do not short-circuit the fuse holder. Before replacing the fuse, make sure that the product is OFF and disconnected from the AC outlet.

• Protective Ground

Before turning the product ON, make sure that it is connected to Ground. This is to prevent the risk of electric shock.

Never cut internal or external Ground wires. Likewise, never remove Ground wiring from the Protective Ground Terminal.

• Operating Conditions

Always install in accordance with the manufacturer's instructions.

To avoid the risk of electric shock and damage, do not subject this product to any liquid/rain or moisture. Do not use this product when in close proximity to water.

Do not install this product near any direct heat source.

Do not block areas of ventilation. Failure to do so could result in fire.

Keep product away from naked flames.

IMPORTANT SAFETY INSTRUCTIONS

Read these instructions

Follow all instructions

Keep these instructions. Do not discard.

Heed all warnings.

Only use attachments/accessories specified by the manufacturer.

• Power Cord and Plug

Do not tamper with the power cord or plug. These are designed for your safety.

Do not remove Ground connections!

If the plug does not fit your AC outlet seek advice from a qualified electrician.

Protect the power cord and plug from any physical stress to avoid risk of electric shock.

Do not place heavy objects on the power cord. This could cause electric shock or fire.

• Cleaning

When required, either blow off dust from the product or use a dry cloth.

Do not use any solvents such as Benzol or Alcohol. For safety, keep product clean and free from dust.

• Servicing

Refer all servicing to qualified service personnel only. Do not perform any servicing other than those instructions contained within the User's Manual.

PREFACE

Dear Customer:

Thank you for choosing the ▲LTO MX-30 3-Channel DJ Mixer, which is the result of our ▲LTO AUDIO TEAM's endeavours.

For the ▲LTO AUDIO TEAM, music and audio are more than a profession, it is a passion and an obsession!

We have, in fact, been designing professional audio products for a number of years in cooperation with many of the world's major brands.

The ▲LTO line represents unparalleled analogue and digital products made by musicians, for musicians. With our design centres in Italy, the Netherlands, and the United Kingdom we provide you with world-class designs, while our software development teams continue to develop an impressive range of audio specific algorithms.

By purchasing our ▲LTO products you become the most important member of our ▲LTO AUDIO TEAM. We would like to share with you our passion for what we design and invite you to make suggestions, which will aid us in developing future products for you. We guarantee you our commitment for quality, continual research and development, and of course the best prices.

The ▲LTO MX-30 is an extremely flexible 3-Channel DJ Mixer, configured with three input channels, which is equipped with a variety of key features including 3 phone/line inputs; 1 microphone input; treble, middle and bass EQ on each channel, crossfader curve etc..

We would like to thank all the people who made the ▲LTO MX-30 3-Channel DJ Mixer possible, especially to our designers and ▲LTO staff. It is their passion for music and professional audio that has made it possible for us to offer you, our most important team member, our continued support.

Thank you very much

▲LTO AUDIO TEAM

TABLE OF CONTENTS

| | |
|---|-----------|
| 1. INTRODUCTION..... | 4 |
| 2. FEATURE LIST..... | 4 |
| 3. CONTROL ELEMENTS..... | 5 |
| 3.1 The Top Cover | |
| 3.1.1 CHANNEL Section | |
| 3.1.2 MAIN OUT Section | |
| 3.1.3 PFL Section | |
| 3.1.4 LEVER METER Section | |
| 3.1.5 CROSSFADER Section | |
| 3.2 The Front Panel | |
| 3.2.1 MIC IN Jack | |
| 3.2.2 PHONE OUT Jack | |
| 3.2.3 REVERSE Switch | |
| 3.2.4 CROSSFADER CURVE Control | |
| 3.3 The Rear Panel | |
| 3.3.1 AC Inlet and Fuse Holder | |
| 3.3.2 POWER Switch | |
| 3.3.3 GND Screw | |
| 3.3.4 MAIN OUT | |
| 3.3.5 EFFECTS Send and Return | |
| 3.3.6 INPUT | |
| 4. TECHNICAL SPECIFICATIONS..... | 11 |
| 5. SYSTEM BLOCK DIAGRAM..... | 12 |
| 6. WARRANTY..... | 13 |

1. INTRODUCTION

What a great DJ mixer you have just bought. Your MX-30 is packed with features such as 3 turntable inputs 3 line inputs, 1 microphone input, 3 bands equalizer and gain control for per channel etc..

Through your MX-30 is very easy to operate, for getting the best out of your MX-30, please go through this manual carefully.

2. FEATURE LIST

- 8 Inputs: 3 phono and 3 line inputs, 1 microphone input, 1 return
- Main outputs through RCA connectors, headphone output via 1/4" TRS jack
- Gain control on each channel
- Bass, middle, treble equalizer on each channel
- PFL button
- TALK control
- Crossfader control
- Accurate LED Meter (10-segment)
- Manufactured under QS9000, VDA6.1 certified management system

3. CONTROL ELEMENTS

3.1 The Top Cover

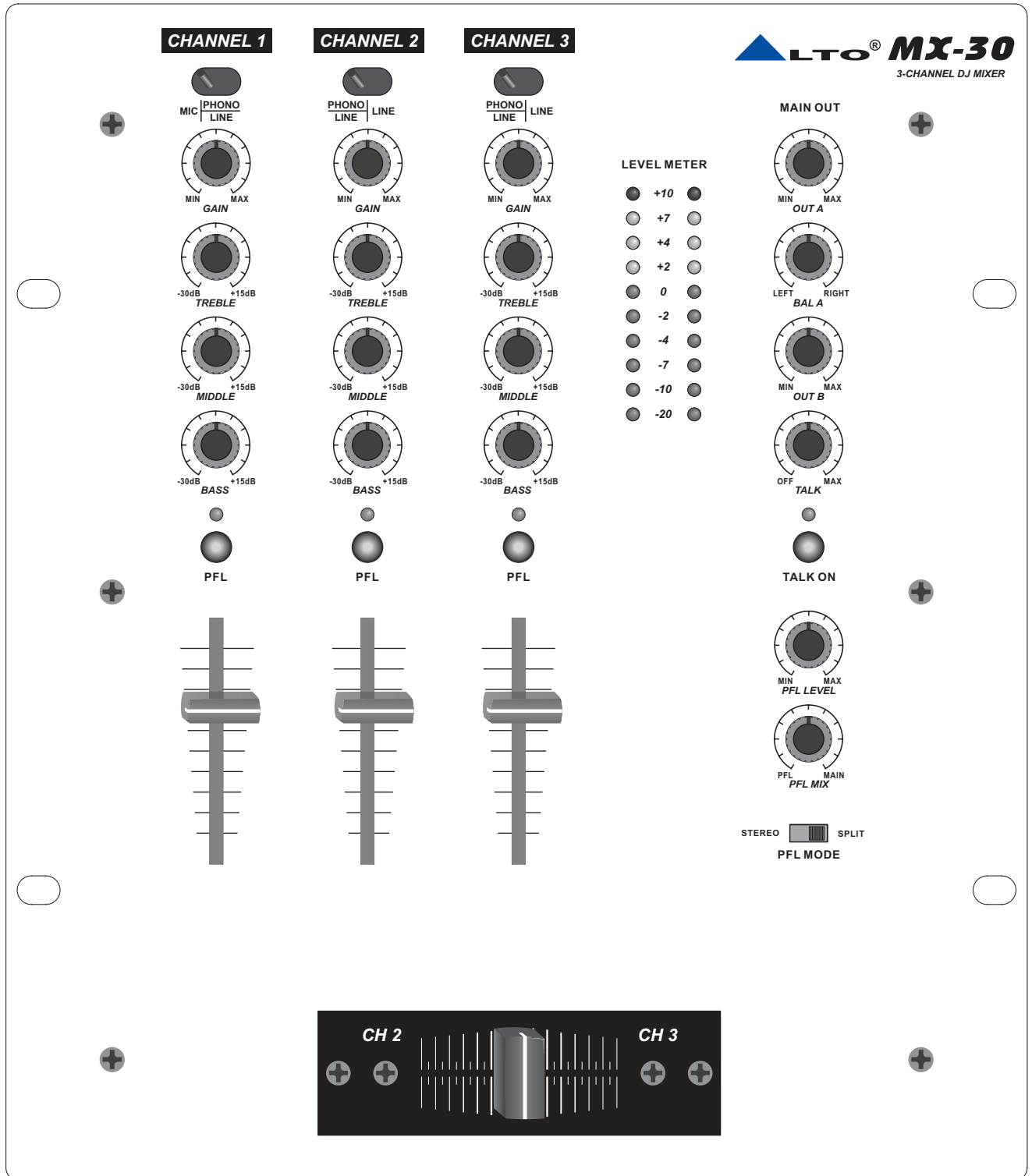

3.1.1 The CHANNEL Section

- MIC to PHONO-LINE Switch 1

The channel 1 is equipped with the MIC to PHONO-LINE switch. This switch is used to select microphone input and phono/line Input. When it is in the right position, you can use the PHONO/LINE switch on the rear panel to input the line signal to the phono input connector.

- PHONO-LINE to LINE Switch 2

This switch is available on input channel 2 and channel 3. You should use the LINE position for all high level audio signals such as CD Players, DAT, MD, etc.. You should use the PHONO-LINE position to connect the turntables making sure that the PHONO-LINE switch on the rear panel is on PHONO position. With this switch (the one on the rear panel) on LINE position, the Input Channel will accept a high level audio signal.

- GAIN Control 3

Via this knob you will adjust the input level. Do not turn this control too much clockwise or you will overload the channel and do not turn it too much counterclockwise or you will generate background hiss.

- EQUALIZER Control

Each input channel is provided with 3 bands equalizer: Treble 4, Middle 5 and Bass 6, and you can adjust the gain range of each from -30dB to +15dB.

- PROGRAM Fader 7

There is a program fader available on each input channel. These faders are used to adjust the overall level of the input channels.

- PFL Button 8

Engage this button to route the input signal of corresponding channel to PFL section, and the corresponding LED illuminates.

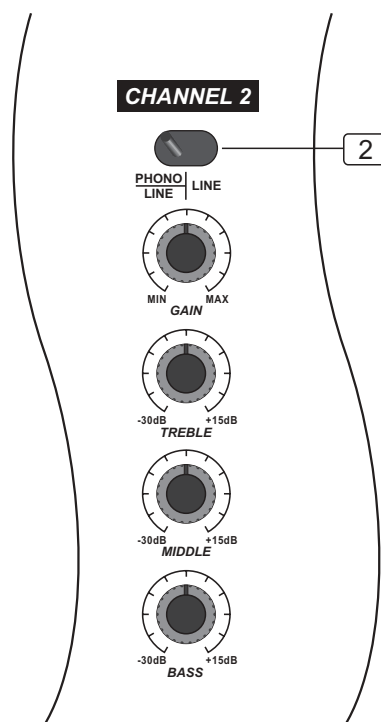
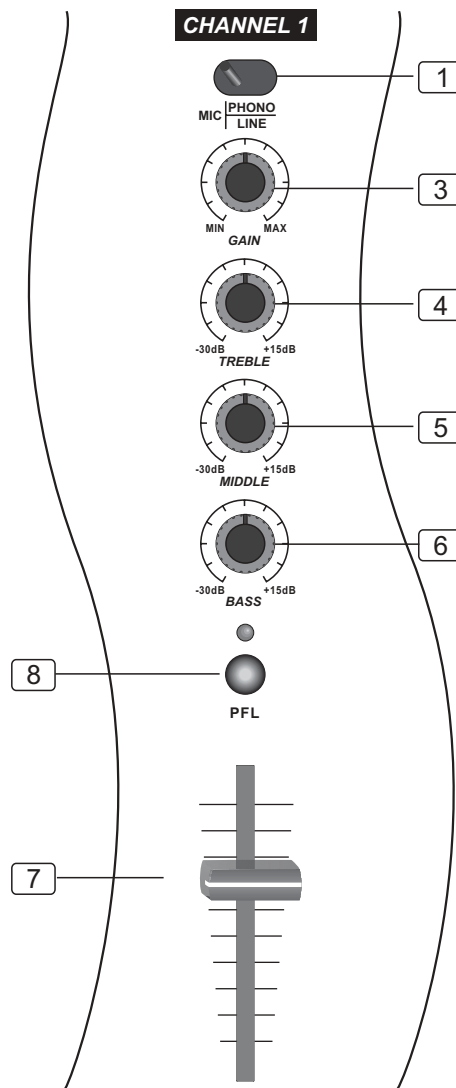

3.1.2 The MAIN OUT Section

- OUT A Control 9

The OUT A control is used to adjust the main level of the AMP output on rear panel.

- BAL A Control 10

The BAL A control is used to adjust the stereo balance of the AMP output on rear panel.

- OUT B Control 11

The OUT B control is used to adjust the main level of the BOOTH output on rear panel.

- TALK Control 12

When you speak through a connected microphone, the volume of the reproduced music will be automatically reduced by the mixer for better intelligibility of your voice. You can determine yourself how much the volume of the music will be reduced via this control. You can turn off the TALK function via this button 13.

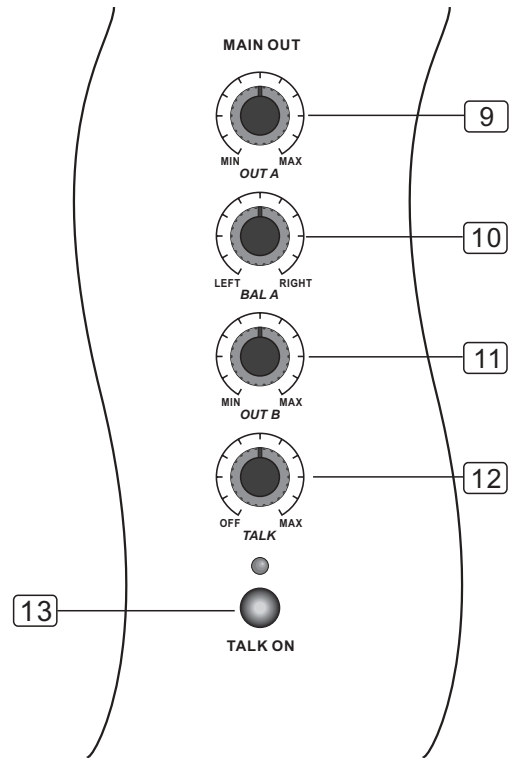

3.1.3 The PFL Section

When you connect a headphone to your MX-30, you have the chance of pre-listening the audio signal before the signal reach the main output.

-PFL LEVEL Control 14

This knob will adjust the level of the headphone signal.

-PFL MIX Control 15

When set the switch mode 16 in STEREO position, you can fade between PFL and MAIN output.

-PFL MODE Switch 16

This is a 2-position switch. When the switch is in STEREO position, the PFL MIX control will fade between PFL signal and MAIN output. When the switch is in SPLIT position, the PFL MIX control has no influence on the PFL signal.

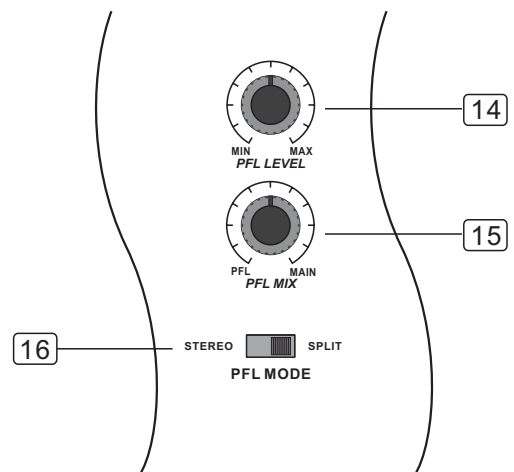

3.1.4 The LEVEL METER Section

-LEVEL METER Display 17

This 10 segments LED's Meter will monitor the output level.

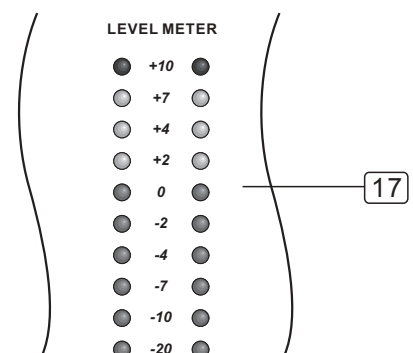

3.1.5 The CROSSFADER Section

- FADER Control 18

Through this crossfader you can fade in between channel 2 and channel 3. The crossfader on your MX-30 is user replaceable.

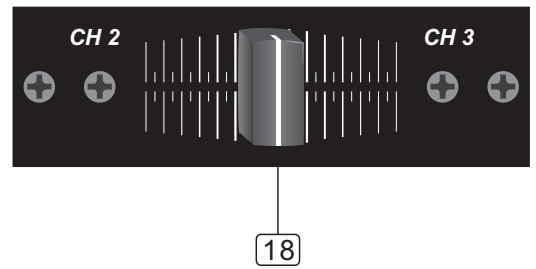

3.2 The Front Panel

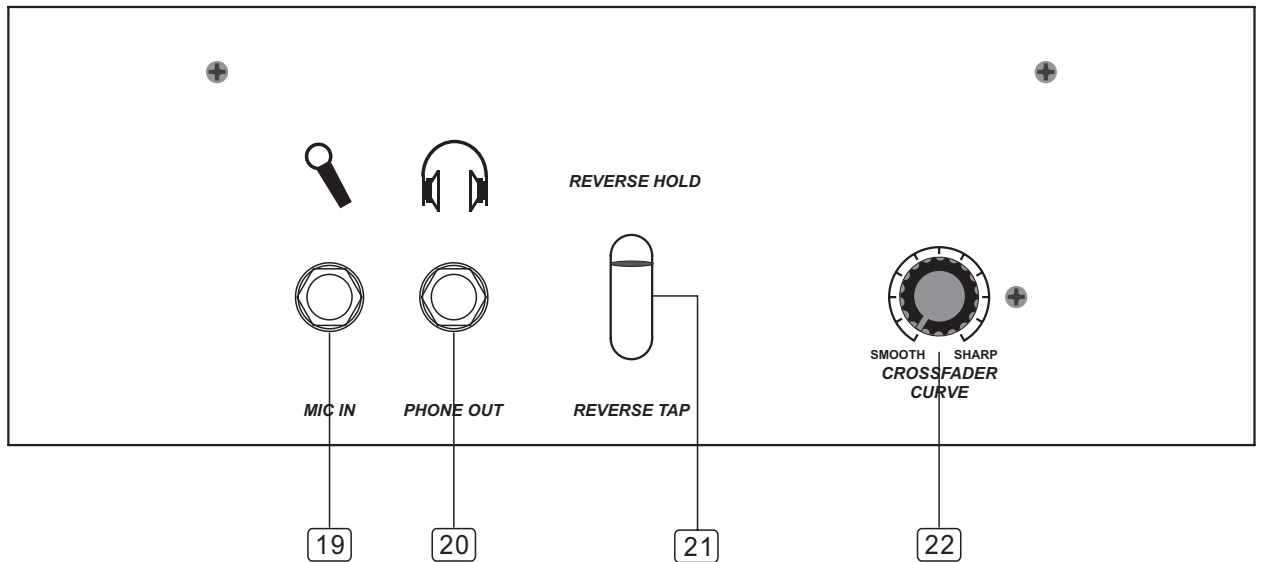

3.2.1 MIC IN Jack 19

This input will accept any unbalanced low impedance microphone. The functions of the microphone will be controlled by the CHANNEL section on the top cover.

3.2.2 PHONE OUT Jack 20

This input will accept a standard headphone with a 1/4" stereo jack

3.2.3 REVERSE Switch 21

This switch will invert the direction of the crossfader so that an immediate inversion of the two channels will be achieved. This switch has two functions: TAP and HOLD.

In TAP function the both channels will be reversed instantly and will go back in their original set as soon as you release the switch in center position

In HOLD function the both channels will be locked in the reverse position. To cancel the effect you will need to push back the switch in the center position.

3.2.4 CROSSFADER CURVE Control 22

Via this knob you will adjust the crossfader curve. When set the knob at the SHARP position, the switching speed between CH 2 and CH 3 will be changed quite quickly by the crossfader even if you move the fader slowly; at the smooth position, the switching speed will be changed much more slowly by the crossfader even if you move the fader quickly.

3.3.5 EFFECTS Send and Return

You can send the PFL signal through the SEND **29** sockets to a signal processor such as reverb, equaliser, etc.. Then from the same effect unit you bring the signal back into the MX-30 via the RETURN **30** sockets and the audio signal is routed into the MAIN output.

3.3.6 INPUT

- PHONO input **31**: The three Channels feature PHONO inputs including RIIA preamplifier for turntable. PIN (RCA) jacks shall be used to connect the turntable.

- LINE input **32**: Through these RCA type sockets you can connect a CD player, an MD player or any other high level device such as Tape Recorder, DAT, etc..

Important Notice: If you wish to connect LINE level devices into the LINE/PHONO input, make sure that the LINE/PHONO switch **33** is on LINE position otherwise the sensitive RIIA preamplifier built-in in the Phono input will be overloaded and will produce distortion.

4. TECHNICAL SPECIFICATIONS

| | | |
|---------------------|--------------------------------|--|
| INPUTS | | |
| | Phono Inputs 1,2 and 3 | 40dB gain@1kHz,unbalanced |
| | Line Inputs 1,2 and 3 | 0dB gain, unbalanced |
| | Mic Input | 40dB gain, servo-balanced |
| | Return | 0dB gain, unbalanced |
| OUTPUTS | | |
| | Headphones | typically 125mW@ 1% THD |
| | Main Out | max +21dBu |
| | Booth Out | max +21dBu |
| | Tape Out | typically 0dBu |
| | Send | typically 0dBu |
| GENERAL | | |
| | Stereo Bass | +15dB/ - 30dB@ 50Hz |
| | Stereo Middle | +15dB/ - 30dB@2.5KHz |
| | Stereo Treble | +15dB/ - 30dB@10KHz |
| | Signal - to - Noise ratio(S/N) | >90dB(LINE) |
| | Crosstalk | 70dB ± 3dB(LINE) |
| | Distortion(THD) | <0.05% |
| | Frequency Response | 20Hz - 20KHz (±2dB) |
| | Input Gain Adjustment | - 20dB - +9dB (+3dB) |
| POWER SUPPLY | | |
| | Connector type | 3 - pole IEC, grounded |
| | Main Voltage | USA/Canada100 - 120V~, 60Hz |
| | | Europe210 - 230V~, 50Hz |
| | | U.K./Australia240V~, 50Hz |
| | Power Consumption | 25watts |
| | Fuse | 95 - 120V~ : T500mAL |
| | | 210 - 240V~ : T315mAL |
| PHYSICAL | | |
| | Dimension | 248(L)×245(W)×76.6(H)mm (9.8"×9.6"×3.0") |
| | Weight | 2.9Kg (6.39lb) |

5. SYSTEM BLOCK DIAGRAM

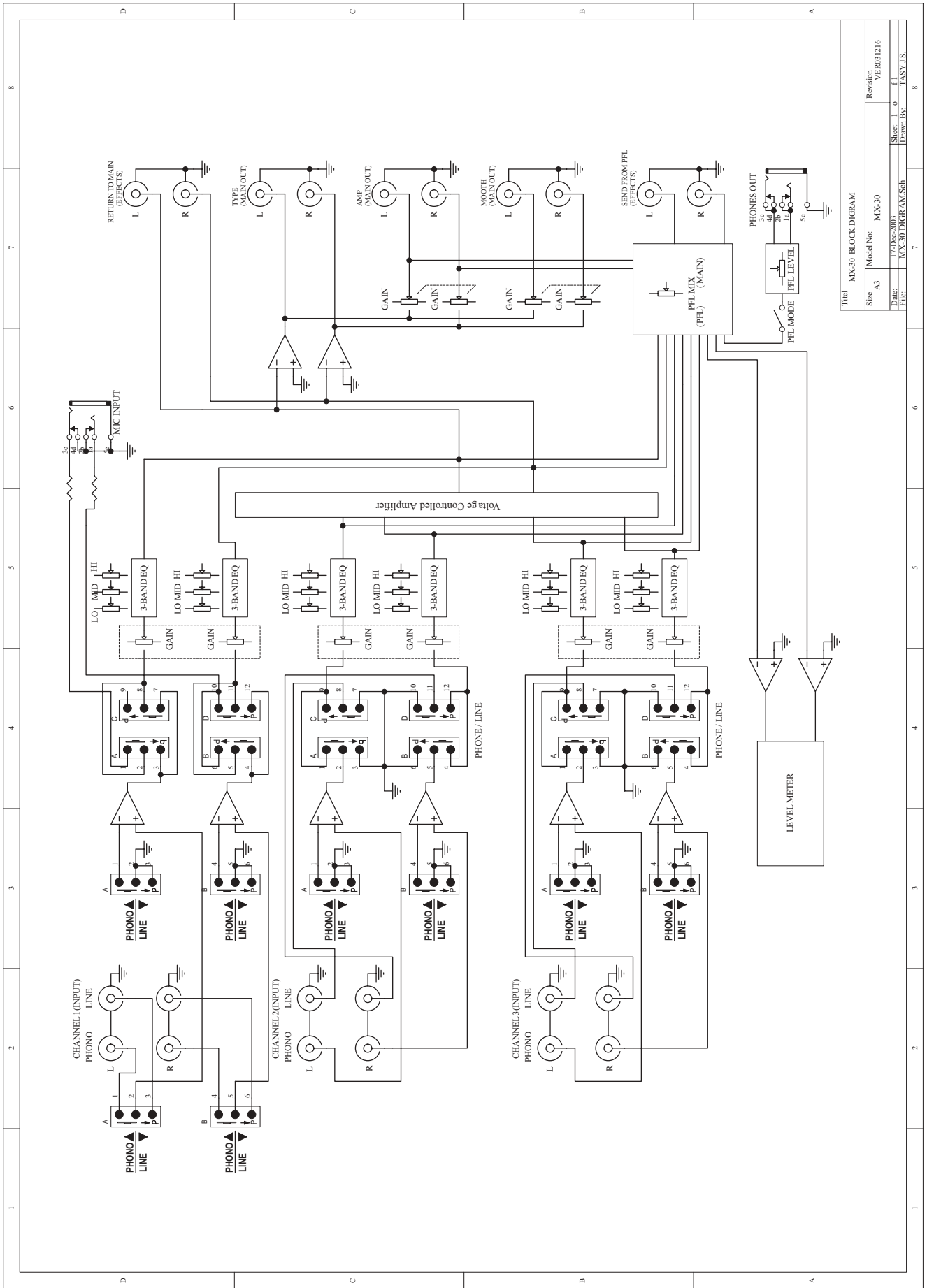

| | | | |
|-------|-----------------|---------------------|-----------|
| Title | | MX-30 BLOCK DIAGRAM | |
| Size | A3 | Model No. | MX-30 |
| Drawn | 17-12-2003 | Revision | VER031216 |
| File | MX-30 DGRAM.Sch | Sheet | 1 of 1 |
| | | Drawn By | LASY J.S. |

6. WARRANTY

1. WARRANTY REGISTRATION CARD

To obtain Warranty Service, the buyer should first fill out and return the enclosed Warranty Registration Card within 10 days of the Purchase Date.

All the information presented in this Warranty Registration Card gives the manufacturer a better understanding of the sales status, so as to purport a more effective and efficient after-sales warranty service.

Please fill out all the information carefully and genuinely, miswriting or absence of this card will void your warranty service.

2. RETURN NOTICE

2.1 In case of return for any warranty service, please make sure that the product is well packed in its original shipping carton, and it can protect your unit from any other extra damage.

2.2 Please provide a copy of your sales receipt or other proof of purchase with the returned machine, and give detail information about your return address and contact telephone number.

2.3 A brief description of the defect will be appreciated.

2.4 Please prepay all the costs involved in the return shipping, handling and insurance.

3. TERMS AND CONDITIONS

3.1 ▲LTO warrants that this product will be free from any defects in materials and/or workmanship for a period of 1 year from the purchase date if you have completed the Warranty Registration Card in time.

3.2 The warranty service is only available to the original consumer, who purchased this product directly from the retail dealer, and it can not be transferred.

3.3 During the warranty service, ▲LTO may repair or replace this product at its own option at no charge to you for parts or for labor in accordance with the right side of this limited warranty.

3.4 This warranty does not apply to the damages to this product that occurred as the following conditions:

- Instead of operating in accordance with the user's manual thoroughly, any abuse or misuse of this product.
- Normal tear and wear.
- The product has been altered or modified in any way.
- Damage which may have been caused either directly or indirectly by another product / force / etc.
- Abnormal service or repairing by anyone other than the qualified personnel or technician.

And in such cases, all the expenses will be charged to the buyer.

3.5 In no event shall ▲LTO be liable for any incidental or consequential damages. Some states do not allow the exclusion or limitation of incidental or consequential damages, so the above exclusion or limitation may not apply to you.

3.6 This warranty gives you the specific rights, and these rights are compatible with the state laws, you may also have other statutory rights that may vary from state to state.

SEIKAKU TECHNICAL GROUP LIMITED
No. 1, Lane 17, Sec. 2, Han Shi W. Road, Taichung, 401 Taiwan
<http://www.altomobile.com> Tel: 886-4-22313737
email: info@altomobile.com Fax: 886-4-22346757

All rights reserved to ALTO Mobile. Due to continued development in response to customer feedback, product features, specifications and/or internal/external design may be changed without prior notice. No photocopying, translation or reproduction of any part of this user manual is allowed without prior written permission. Copyright © 2004 Seikaku Technical Group Limited.