

# User's Manual

## MAXIDRIVE2.3+

2 – WAY STEREO  
DIGITAL CROSSOVER

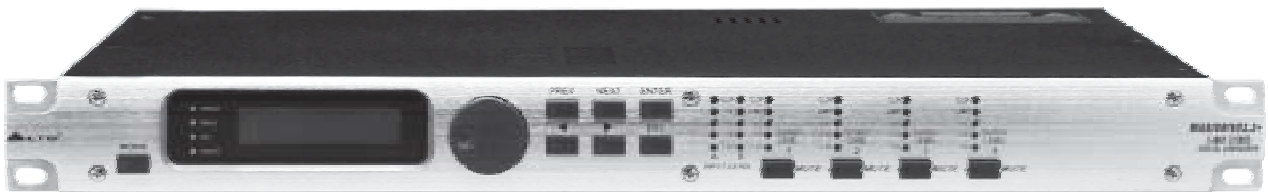

[www.altoproaudio.com](http://www.altoproaudio.com)  
Version 1.0 November 2003  
— English —



## SAFETY RELATED SYMBOLS



This symbol, wherever used, alerts you to the presence of un-insulated and dangerous voltages within the product enclosure. These are voltages that may be sufficient to constitute the risk of electric shock or death.



This symbol, wherever used, alerts you to important operating and maintenance instructions. Please read.

-  Protective Ground Terminal
-  AC mains (Alternating Current)
-  Hazardous Live Terminal

**ON:** Denotes the product is turned on.

**OFF:** Denotes the product is turned off.

### WARNING

Describes precautions that should be observed to prevent the possibility of death or injury to the user.

### CAUTION

Describes precautions that should be observed to prevent damage to the product.

## WARNING

### • Power Supply

Ensure that the mains source voltage (AC outlet) matches the voltage rating of the product. Failure to do so could result in damage to the product and possibly the user.

Unplug the product before electrical storms occur and when unused for long periods of time to reduce the risk of electric shock or fire.

### • External Connection

Always use proper ready-made insulated mains cabling (power cord). Failure to do so could result in shock/death or fire. If in doubt, seek advice from a registered electrician.

### • Do Not Remove Any Covers

Within the product are areas where high voltages may present. To reduce the risk of electric shock do not remove any covers unless the AC mains power cord is removed.

**Covers should be removed by qualified service personnel only.**

No user serviceable parts inside.

### • Fuse

To prevent fire and damage to the product, use only

the recommended fuse type as indicated in this manual. Do not short-circuit the fuse holder. Before replacing the fuse, make sure that the product is OFF and disconnected from the AC outlet.

### • Protective Ground

Before turning the product ON, make sure that it is connected to Ground. This is to prevent the risk of electric shock.

Never cut internal or external Ground wires. Likewise, never remove Ground wiring from the Protective Ground Terminal.

### • Operating Conditions

Always install in accordance with the manufacturer's instructions.

To avoid the risk of electric shock and damage, do not subject this product to any liquid/rain or moisture. Do not use this product when in close proximity to water.

Do not install this product near any direct heat source.

Do not block areas of ventilation. Failure to do so could result in fire.

Keep product away from naked flames.

## IMPORTANT SAFETY INSTRUCTIONS

Read these instructions

Follow all instructions

Keep these instructions. Do not discard.

Heed all warnings.

Only use attachments/accessories specified by the manufacturer.

### • Power Cord and Plug

Do not tamper with the power cord or plug. These are designed for your safety.

Do not remove Ground connections!

If the plug does not fit your AC outlet seek advice from a qualified electrician.

Protect the power cord and plug from any physical stress to avoid risk of electric shock.

Do not place heavy objects on the power cord. This could cause electric shock or fire.

### • Cleaning

When required, either blow off dust from the product or use a dry cloth.

Do not use any solvents such as Benzol or Alcohol. For safety, keep product clean and free from dust.

### • Servicing

Refer all servicing to qualified service personnel only. Do not perform any servicing other than those instructions contained within the User's Manual.

## PREFACE

Dear Customer:

Thanks for choosing MAXIDRIVE2.3+ 2 - Way Stereo Digital Crossover and thanks for choosing one of the results of ▲LTO AUDIO TEAM job and researches.

For our ▲LTO AUDIO TEAM, music and sound are more than a job...are first of all passion and let us say our obsession!

We have been designing professional audio products for a long time in cooperation with some of the major brands in the world in the audio field.

The ▲LTO line presents unparalleled analogue and digital products made by Musicians for Musicians in our R&D centers in Italy, Netherlands, United Kingdom and Taiwan. The core of our digital audio products is a sophisticated DSP (Digital Sound Processor) and a large range of state of the art algorithms which have been developed by our Software Team for the last 7 years.

Because we are convinced you are the most important member of ▲LTO AUDIO TEAM and the one confirming the quality of our job, we would like to share with you our work and our dreams, paying attention to your suggestions and your comments.

Following this idea we create our products and we will create the new ones! From our side, we guarantee you and we will guarantee you also in future the best quality, the best fruits of our continuous researches and the best prices.

Our MAXIDRIVE2.3+ 2 - Way Stereo Digital Crossover is the result of many hours of listening and tests involving common people, area experts, musicians and technicians. The results of this effort is a DSP hi-performance equalizer that can be used in applications as musical performances, Installation and sound reinforcement. Besides we offer to you a number of factory EQ curves that we collected and transformed in presets now available in our small, efficient and easy to use MAXIDRIVE2.3+.

Nothing else to add, but that we would like to thank all the people that made the MAXIDRIVE2.3+ a reality available to our customers, and thank our designers and all the ▲LTO staff, people who make possible the realization of products containing our idea of music and sound and are ready to support you, our Customers, in the best way, conscious that you are our best richness.

Thank you very much

▲LTO AUDIO TEAM

# TABLE OF CONTENTS

<b>1. INTRODUCTION</b> .....	4
<b>2. FEATURES</b> .....	4
<b>3. CONTROL ELEMENTS</b> .....	4
3.1 The Front Panel	
3.2 The Rear Panel	
<b>4. GETTING STARTED</b> .....	6
4.1 Configuration of The System	
4.2 Adjust The Input Signal	
4.3 First Setup	
4.4 System Configuration	
4.5 Number of Presets	
4.6 Type of Preset	
4.7 Name of The Preset	
4.8 Preset Modifications	
4.9 System Protection	
<b>5. THE MENU MAP CONFIGURATION DESCRIPTION</b> .....	10
5.1 Preset Menu	
5.2 Delay Menu	
5.3 Edit Menu	
5.4 Utility Menu	
<b>6. CONNECTIONS</b> .....	28
<b>7. APPLICATION</b> .....	28
7.1 Factory Preset Configuration	
7.2 Organization	
<b>8. TECHNICAL SPECIFICATIONS</b> .....	34
<b>9. WARRANTY</b> .....	35

## 1. INTRODUCTION

Your MAXIDRIVE2.3+ is a 2-Way Stereo Digital Crossover and it is a powerful versatile signal processor. The apparatus will provide 2, 3 or 4 -way mono X-over with 4 outputs. Thanks to the use of selected and expensive components, the performances of MAXIDRIVE2.3+ are worth much more than its price: you can set the input and output routing configuration only through recalling one of the Presets included in the internal memory.

## 2. FEATURES

- Single rack unit
- 2 input connectors are compatible with balanced XLR and JACK
- 4 outputs are balanced XLR-M connector
- A/D and D/A converters for a 117dB dynamic range
- Delay lines up to 2.5s for each input and up to 300ms for each output
- 6 Factory presets and 64 user presets by large memory capacity
- Switching power supply
- Remote control
- Manufactured under QS9000, VDA6.1 certified management system

## 3. CONTROL ELEMENTS

### 3.1 The Front Panel

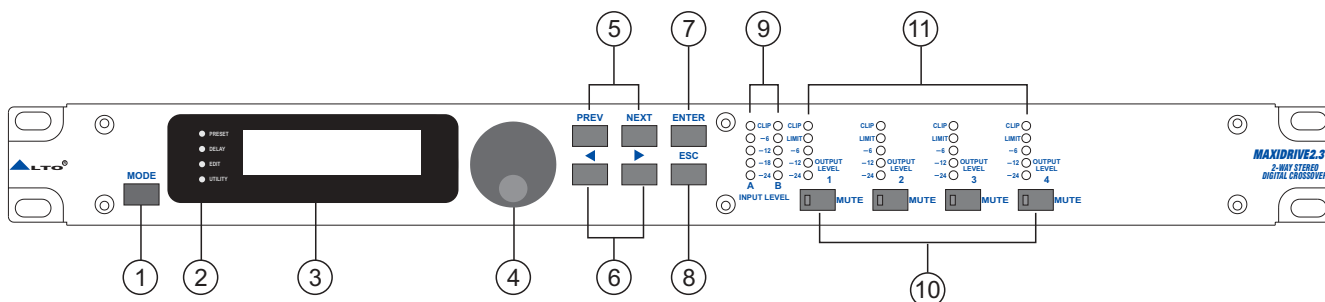

#### 1.MODE Key

The button allows you to select four modes: PRESET, DELAY, EDIT and UTILITY. Pressing MODE repeatedly to reach to the required menu and the corresponding LED will light up. You can edit the parameters of the selected menus. If none of the menu LEDs is lit, the Display shows the name of the current PRESET and no parameters can be modified.

#### 2.LEDs

These LEDs indicate the selecting status of the menus.

#### 3.Display

Rear-lit 2x16 display.

It shows the pages of the various menus and the relative parameters.

#### 4.DIAL Knob

The knob allows you to edit value of the selected parameter. The value raises while turning the DIAL clockwise and lowers counterclockwise.

#### 5.PREV/NEXT Key

Each menu comprises several pages. These buttons allow you to turn over the pages and/or a variable number of parameters.

#### 6.Navigation Cursor Keys

Each editing page comprises a variable number of parameters (fields).

The right and left keys allow you to select the various required parameters via controlling the movement of the cursor in the page.

## 7. ENTER Key

The key allows you to access to the selected editing page. Pressing this key, you can edit and confirm the required value of parameter.

## 8. ESC Key

The key allows you to exit the selected editing page. It also used to reject the value to enter and return to the stored value.

## 9. INPUT LEVEL LED Meters

The LEDs are used to indicate the level of input A/B. In order to get an up-front distortion-free signal, you keep the signal quite high, but do assure that the red CLIP LED doesn't light up continually.

## 10. MUTE Switches

There are four mute switches (1-4). They are used to mute the signal of the respective outputs. When the switch is on, the corresponding LED will light up. These switches can avoid signal peaks when switching on and off the sound system and isolate the individual audio sections during testing or checking sound, etc.. The restored Mute function can be set to use the Wake Up Function (Utility menu Misc. Setup submenu) and can be set as Normal (last setting before the unit was switched off) or Mute (all outputs automatically forced into Mute status).

## 11. OUTPUT LEVEL LED Meters

These LEDs indicate the level of the respective outputs (you can adjust the output via adjusting the Output Gain parameter of Edit menu.)

Note: The LIMITER on any output will change the way in which the level is displayed on the corresponding LED. In fact, the level shown on the ladder is no longer the "absolute" output level, but the level of the signal at -24dB, -12dB, -6dB compared to the limiter threshold (indicated by the orange LIMIT LED).

## 3.2 The Rear Panel

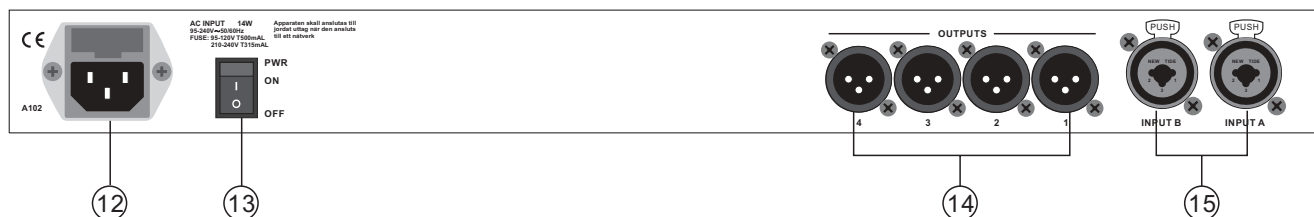

## 12. AC Inlet and Fuse Holder

Use it to connect your MAXIDRIVE2.3+ to the supplied AC cord. Please check the Voltage in your country and what voltage for your MAXIDRIVE2.3+ is configured before attempting to connect the unit for the main AC. The fuse can protect the AC supplies circuit of the equipment.

**CAUTION:** If there is something wrong with the fuse or the fuse needs to change, please refer to a qualified technician. If the fuse continues to blow after replacing, discontinue using of this unit before being repaired.

## 13. Power Switch

The switch is used to turn the main POWER on and off. Note: before turning on the unit, please make sure the amplifiers of the sound system are off to avoid the annoying and sometimes dangerous signal peaks.

## 14. OUTPUTS

These (Outputs1~4) are balanced XLR-M connectors. The high quality, low noise, 20 bit converters can make A/D conversion.

## 15. INPUTS

INPUT A and INPUT B are compatible with balanced XLR and JACK. They are audio connectors of the respective sections. The high quality, low noise, 20 bit converters can make A/D conversion.

## 4. GETTING STARTED

The powerful versatile signal processor MAXIDRIVE2.3+ is mainly designed for use with audio systems. Its routing configurations of the input and output can be only set by recalling one of the PRESETS included in the internal memory. So the user must be very clear about the main function of the unit in order to get a best operation of your MAXIDRIVE2.3+. Before you start your operation, please read the following parts carefully:

### 4.1 Configuration of The System

At first, switch off the equipment, carry out the audio and power connection from the various components of your sound system.

Then, connect the main cord and only switch on the MAXIDRIVE2.3+. The display will show the data regarding with the operating system release for a few seconds.



Meanwhile, the system will restore the exact operating conditions at the time of switching off. And the system Will enter into default status, showing the main operating information on the display.

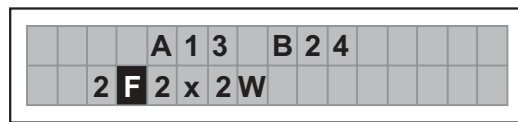

- Set all the MAXIDRIVE2.3+ outputs in MUTE status (LEDs lit) by pressing the relative keys.
- Load the **Factory PRESET** containing the **configuration** you've found.
- Press the **MODE** Key until the **PRESET** menu LED lights up.

The display will show the **Load PRESET** page:

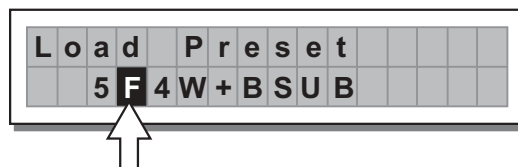

(example)

- Use the **DIAL** to find the necessary Factory PRESET (indicated by the letter **F**). Check that if, among the PRESETS available, there are already some optimised for the specific speaker enclosures being used.
- Press **ENTER**.

The display shows the PRESET loaded in the units memory and the relative configuration:

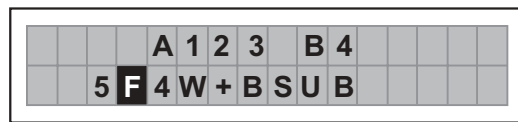

(example)

### 4.2 Adjusting The Input Signal

It is much more important to set the input signal of a digital unit than that of an analog unit, because excessively high input signals will make any saturation of the A/D converters cause a typical particularly distinct noise (high level square wave).

**Proceed as follows:**

- Keep the MAXIDRIVE2.3+ outputs in MUTE status (LEDs light on).
- Feed a signal in on the MAXIDRIVE2.3+'s input and watch the INPUT LEVEL A-B LED ladders.  
To obtain a good signal/noise ratio, i.e. an up-front distortion-free signal, keep the signal quite high, but make certain the red **CLIP** LED doesn't light up continually.
- Find out the output level setting for your mixer (or other unit) and connect it to the input of the MAXIDRIVE2.3+.
- Adjust the MAXIDRIVE2.3+ input gain if necessary:

Press the **MODE** key until the **EDIT** menu LED lights up.

Use the **PREV** and **NEXT** keys to go to the **Input Gain** page:



- Press **ENTER**.

The display will show the **INA Gain or INA&B Gain** page (according to the configuration and other utilities loaded in the memory):



Use the **DIAL** to change the gain value and watch the level of the signal on the LED ladders until the ideal values are reached.

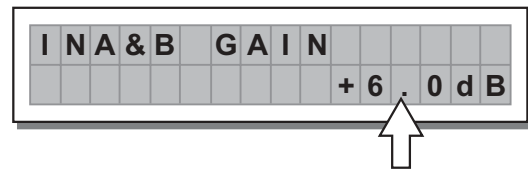
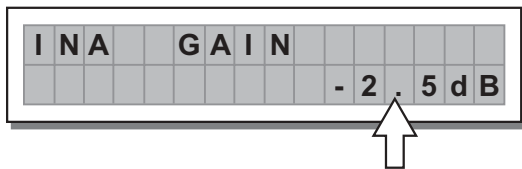

Then use the **PREV** and **NEXT** keys to access to the **INB Gain** page (if there is one, this will depend on the configuration and the other utilities loaded in the memory).

Repeat the settings as explained above.

### 4.3 First Setup

At this point, the first custom setup can be prepared.

The following is only the description of setup procedure.

The detailed specifications of each parameter are shown in the respective paragraphs of the manual.

- Firstly, set the following parameters shown in order:
  - Output Pol.** Polarity of the outputs
  - Xover** Crossover frequencies (separation of the speaker channels)
  - Output Delay** Alignment of the speaker enclosure components
  - Output Gain** Levels of the outputs

**Note:** The regulation of the MAXIDRIVE2.3+'s parameters is closely related to the characteristics of the components of the sound system. So if you're not the expert, please refer to the documentation and technical specifications of your power amplifiers, loudspeaker enclosures, monitors, etc.. This will enable you to work faster and safely.



- Disable the MUTE function on the outputs you intend using and listen the sound, carry out instrumental checks (if you have the necessary equipment) and any corrections required.

• Then, if necessary, adjust the values of the following functions:

**Output EQ** Output equalizers

**Output Limiter** Output limiters

**Note:** In this first phase of setting up your sound system, the adjustment of these functions (which if not Indis -pensable during installation) can wait. But do remember that adjusting the equalizers can also affect the signal level. So if considerable equalization changes are made, remember to check and adjust the output levels too, if necessary.

#### 4.4 System Configuration

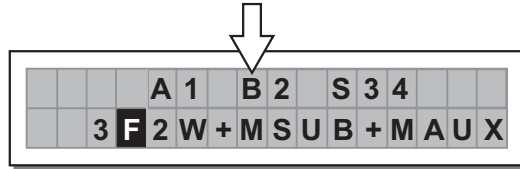

The letters indicate the inputs:

**A** = Input A

**B** = Input B

**S** = SUM (sum of inputs A and B)

Numbers **1**, **2**, **3** and **4** indicate the respective outputs.

**In the example:**

The signal connected to Input **A** is assigned to outputs **1**.

The signal connected to Input **B** is assigned to outputs **2**.

The **Sum** of the signal on inputs **A** and **B** is assigned to outputs **3** and **4**.

The system is therefore configured as shown in the following diagram.

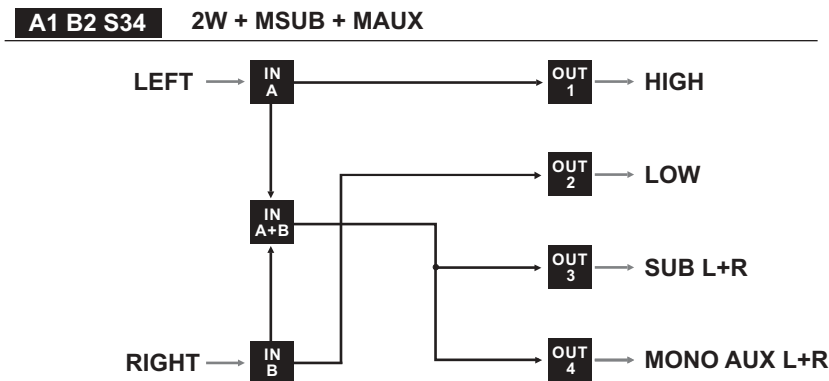

#### 4.5 Number of PRESETS

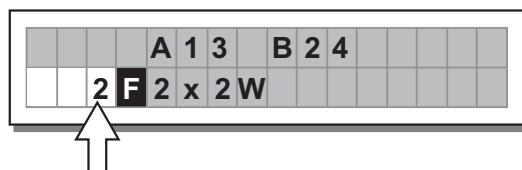

6 Factory PRESETS and 64 User PRESETS.

## 4.6 Type of PRESET

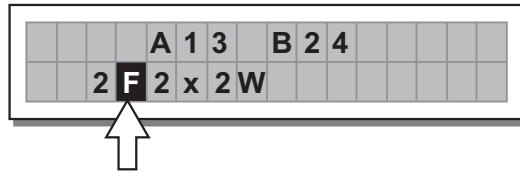

There are 2 categories of PRESETS:

- F** = Factory PRESETS      factory programmed, cannot be permanently changed. These include all the system's usable configurations. These are the starting points for Creating User PRESETS from scratch.
- U** = User PRESETS      can be programmed by users.

## 4.7 Name of the PRESET

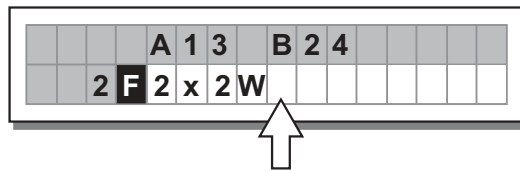

In the example, the name indicates a two-way stereo system.

## 4.8 PRESET Modifications

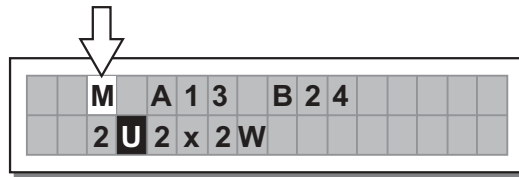

This indicates that the value of one or more parameters has been temporarily modified with respect to the stored in the PRESET shown.

Practically speaking, this indication means that the changes made to the PRESET have not been stored.

**Note:** once it has been enabled, the indication remains even if the "original" values are reset manually. The indication disappears as soon as the PRESET is saved or as soon as a new PRESET is loaded (including this same PRESET).

In other words, the indication disappears as soon as stored values are accessed.

If the PRESET isn't saved, temporary changes are lost as soon as a new PRESET is loaded (including this same PRESET).

**Note:** temporary changes are kept on the other hand in the "buffer memory": when the unit is switched on, the system maintains exactly the same settings as when the unit was switched off, including temporary changes.

## 4.9. System Protection

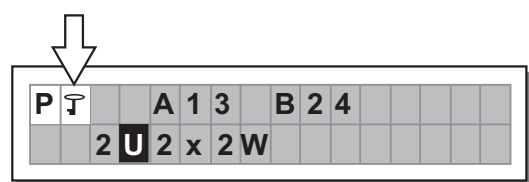
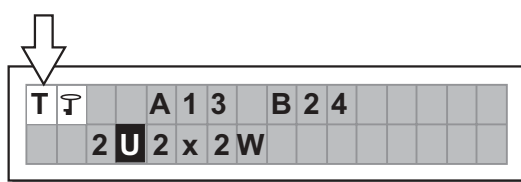

These indications appear when the **LOCK** function (**UTILITY** menu) is enabled, i.e. when the system is totally (**T**) or partially (**P**) protected against accidental or unauthorized changes (even if temporary). Protection is ensured by a **password**, without which editing procedure can't be unlocked.

## 5. THE MENU MAP CONFIGURATION DESCRIPTION

The control software is organized in **PRESET**, **DELAY**, **EDIT** and **UTILITY** menus, each of which contains the relative types of parameters and functions.

### 5.1. Preset Menu



There are 2 distinct categories of PRESETS:

#### Factory PRESETS

Factory-programmed storage.

Factory PRESETS can be used normally, temporarily modified, but can't be cancelled, overwritten or permanently modified. Factory PRESETS contain some specific settings for certain types of enclosures and all the system's usable configurations. For this reason they're the ideal starting point for creating custom PRESETS.

#### User PRESETS

Stored data that can be programmed by users.

User PRESETS are internal memory areas in which your own personal settings can be saved.

#### 5.1.1 Load PRESET

This menu page allows the required PRESET to be loaded and made operatively.

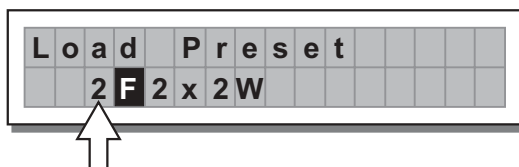

To load a PRESET:

- Use the **DIAL** to reach the required PRESET.  
6 Factory PRESETS and 64 User PRESETS.

**Note:** since the system must always be configured, there are no empty memory areas. All the User areas unused by custom **PRESETS** are automatically occupied by the **\*Default\* PRESET**, which contains a standard start configuration with all the values of the various parameters at zero.

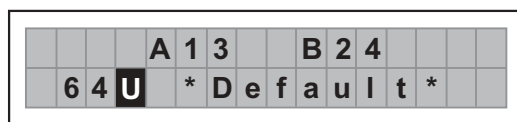
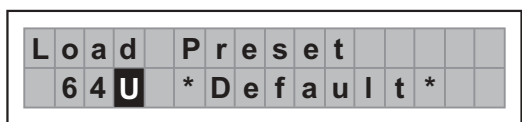

- Press **ENTER**.

The system returns to default status and the display shows the information on the PRESET that has just been loaded.



**Note:** In the example, **Factory PRESET #2**, named "2x2W" has been loaded: Its system configuration is Input A signal assigned to outputs 1 and 3; Input B signal assigned to outputs 2 and 4.

### 5.1.2 Store & Naming PRESET

Use this menu to create new PRESETS, i.e. to save all the current system settings.

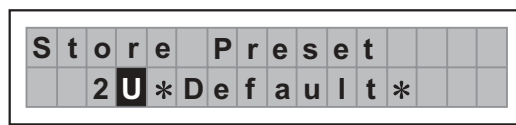

To save a PRESET:

Use **DIAL** to reach the memory area in which the PRESET is to be saved.

**Note:** In this procedure, the **Factory PRESET** areas aren't available, since the **Factory PRESETS** can not be permanently remember that it is possible to load a **Factory PRESET**, modified. Nevertheless save it in a **User PRESET** area, modify it as required and then store it again in the same **User** area.

**Note:** Scrolling through the memory areas, the display shows the number, type and name of the **PRESETS** contained in them:

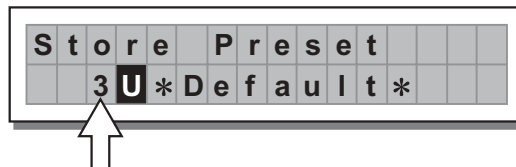

Press **ENTER**. The **PRESET Naming** page appears, by means of which it is possible to edit the name of the PRESET to be saved.

The name of the 'start' PRESET (i.e. of the PRESET currently loaded) is proposed as default. The cursor takes up position on the first of the twelve character spaces available.

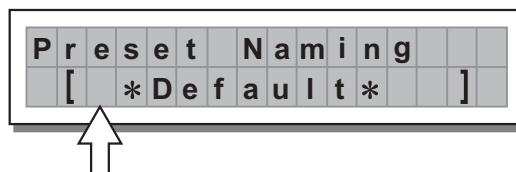

At this point:

- If you decide to accept and confirm the name suggested, press **ENTER**.
- If you want to abort **Naming** procedure (for example because you've chosen the wrong memory area) and return to Store PRESET procedure, press **ESC**.

- If you want to assign a new name to the PRESET you're storing:
  - use the ◀ and ▶ keys to position the cursor on the required character
  - use **DIAL** to enter the alphanumeric value wanted
  - after finishing, press **ENTER**.

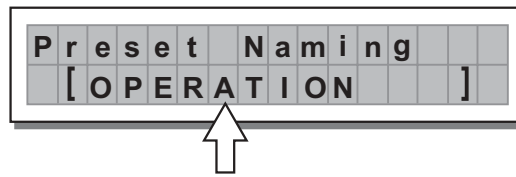

## 5.2.Delay Menu

Use this menu to work on the systems delay lines.

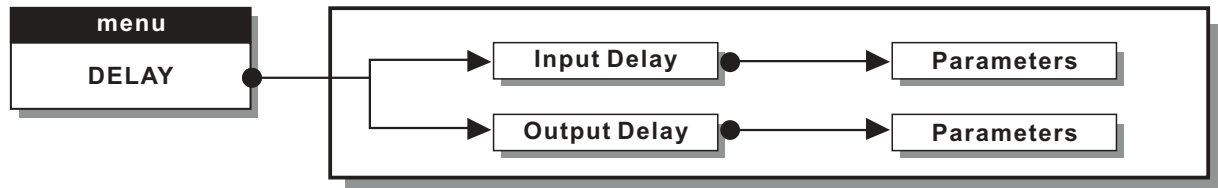

### Parameters

In these pages, the number of the parameters and how they are presented varies according to the configuration of the PRESET and according to **Ganging** and **Units** settings (**UTILITY** menu). In fact, these pages only show the parameters that can actually be used, in the most suitable form of editing.

### The practical differences between **Delay Input** and **Delay Output**

A Delay is only a processor by means of which a signal is deliberately delayed by a programmable length of time. From a technical point of view, the Delays applied to the inputs and outputs are equivalent. Nevertheless, their application is different:

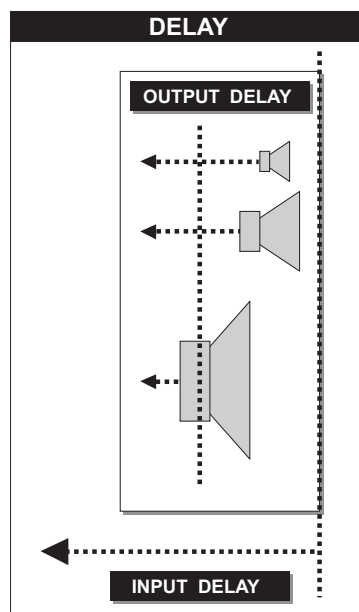

**Input Delay** delays the signal of an input (or the sum of the inputs) before sending it to the routing system. In this way, all the outputs which depend on that input are delayed by the same length of time. Also called **Master Delay**, input Delay is mainly used to compensate for the effects due to the distance between the various speaker enclosures or between various blocks of a complex sound system (for example in large concert halls, stadiums, etc.), Thus achieving virtual alignment.

**Output Delay** only delays the signal of a specific output.

Also called Channel Delay, output delay is mainly used to compensate for the distance between different blocks of the same sound system (for example clusters) or to correct internal alignment of a speaker enclosure components.

### 5.2.1 Input Delay

Use this menu page to adjust the delay lines of Input A, Input B and SUM.

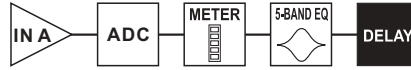

The values can be set in the following ranges:

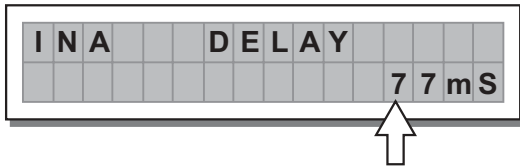

INPUT DELAY		
unit	range	step
m	0.0 ~ 900.0	0.5
mm	0 ~ 900000	7
ms	0 ~ 2621	1
us	0 ~ 2621438	21

The measurement unit can be chosen with the function **Delay Unit** (UTILITY menu - Units submenu).

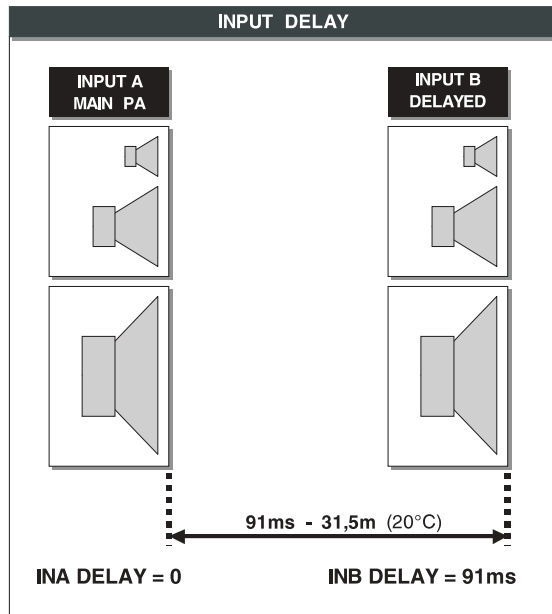

### 5.2.2 Output Delay

Use this menu page to adjust the delay lines of outputs 1, 2, 3 and 4.

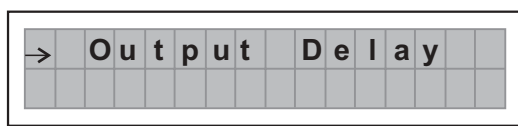

The values can be set in the following ranges:

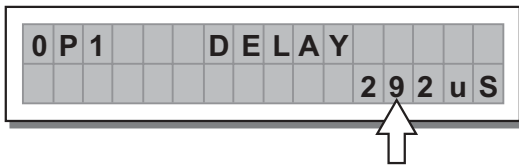

OUTPUT DELAY		
unit	range	step
m	0.0 ~ 100.0	0.5
mm	0 ~ 100000	7
ms	0 ~ 291	1
us	0 ~ 291271	21

The values can be set in the following ranges:

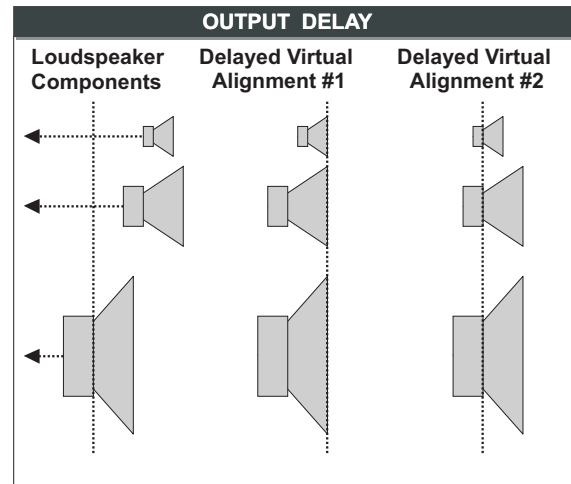
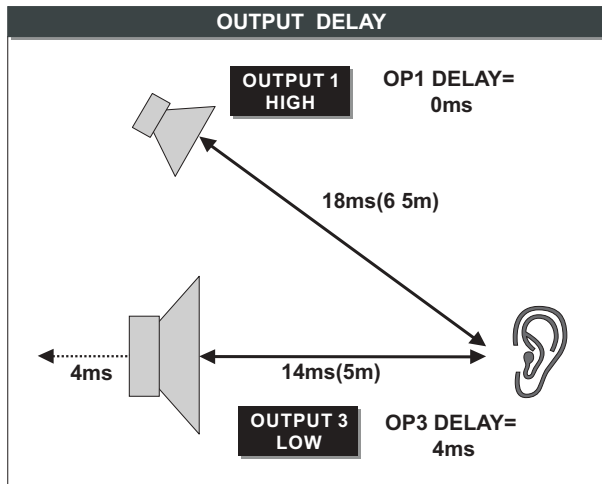

### 5.3 Edit Menu

The values can be set in the following ranges:

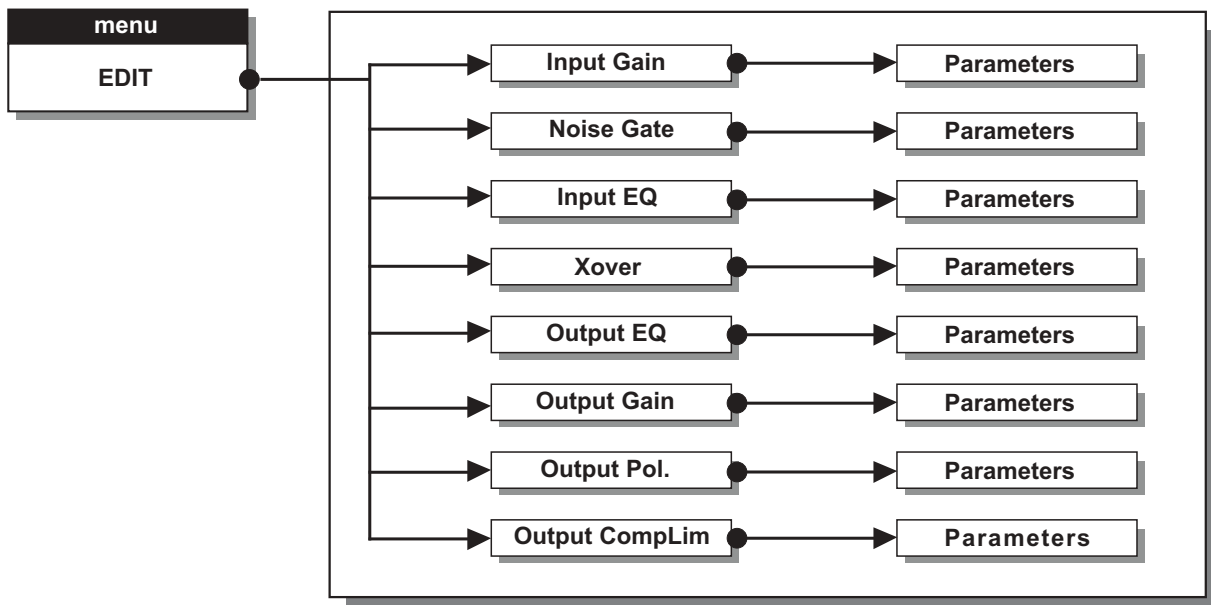

#### Parameters

In these pages, the number of the parameters and how they are presented varies according to the configuration of the PRESET and according to **Ganging** and **Units** settings (**UTILITY** menu). In fact, these pages only show the parameters that can actually be used, in the most suitable form of editing.

### 5.3.1 Input Gain

Input gain control.



Allows to adjust the amplification of the signal fed in through Inputs A and B. Editing values are in the range **+6dB ~ -30dB, with 0.5dB steps.**



**Note:** Setting the input signal of a digital unit is particularly important, much more than on an analog unit, as any saturation of the A/D converter due to an excessively high input signal causes a typical particularly distinct noise. To achieve a good signal/noise ratio, i.e. an up-front distortion free signal, feed a signal in on the MAXI-DRIVE3.4's input and watch the **INPUT LEVEL A-B** LED ladders. Keep the signal quite high, but make certain the red **CLIP** LED doesn't light on continually.

### 5.3.2 Noise Gate

Allows to cut or reduce the background noise generated by the unit connected to the processor's inputs (the mixer, for example). The filter is active when the input signal is below a certain threshold and reduce its level cutting the undesired background noises.

The noise gate control has 4 main parameters: attack, release, threshold and range.

You can use the "ENTER" key to access to the noise gate sub-menu, then select the editing parameter that you want to perform via the "PREV" and "NEXT" keys, use the DIAL to set the value for these parameters.



The attack can be varied from 0.5-100mS, with the 0.5mS per step.  
 The release is in the range 0.01s ~ 4.00s, with the 0.1s per step.  
 The threshold is in the range -80.0 ~ 8, with the 0.5 per step.  
 The range is in the -80 ~ 0, with the 0.5 per step.

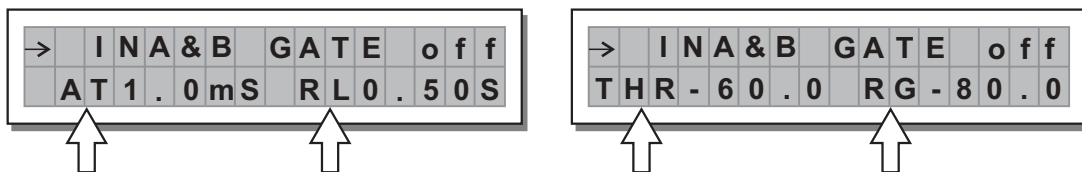

### 5.3.3 Input EQ

Input equalizer with 5 parametric filters.

Allows to alter the overall tone of the signal connected to the respective input.

Also called **Master EQ**, the equalization of the input signal effects all the outputs connected to the input and the input SUM.

This component's characteristic quality and programmability (identical to the output Equalizer) enable it to be Used so effectively and flexibly as to make the use of graphic equalizers often unnecessary.

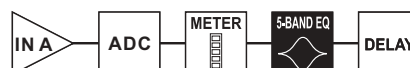
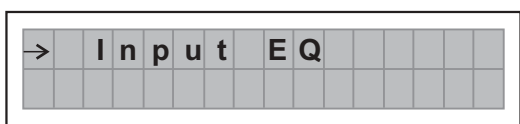



Each equalizer has 5 pages (one for each filter), showing the name of the input it affects and the number of the filter.

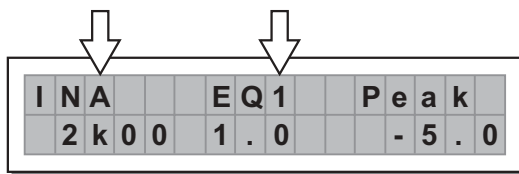

The following editable parameters are available for each filter:

**a. Type of Filter**

Allows to choose among Peaking, Low or High Shelving with a slope of 6 or 12 dB per octave and Notch filter.

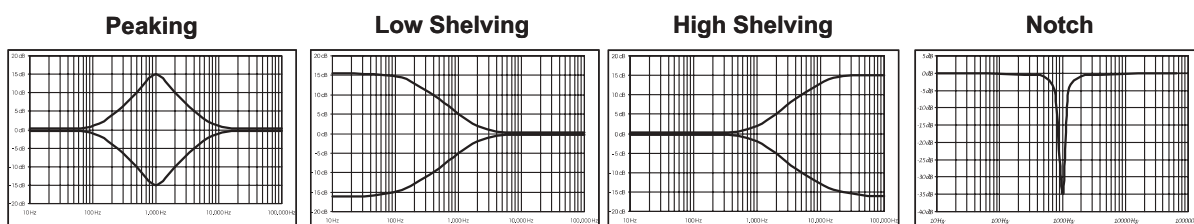
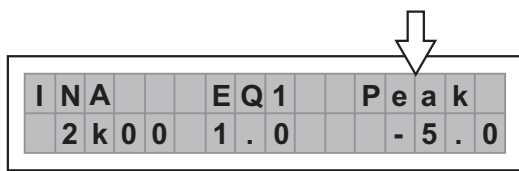

**b. Centre Frequency / Cutoff Frequency**

Allows to choose the centre frequency of the Peaking curve and Notch filter, or the cutoff frequency of Shelving curves.

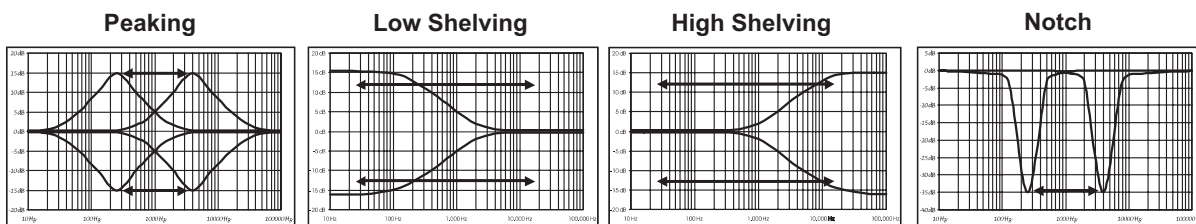
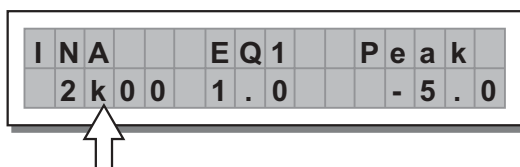

**c. Bandwidth**

Allows to choose the width in octaves of the Peaking or Notch type curve. It s not used with Shelving curves.

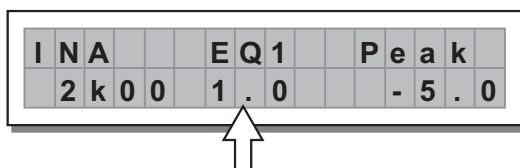

### Peaking

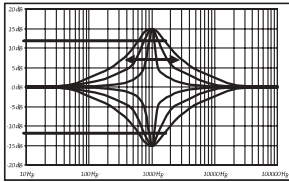

### Notch

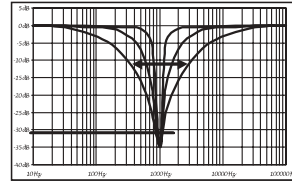

#### d. Gain

Allows to control the boost or cut of the selected frequencies.  
It's not used with the **Notch Filter**, which has a fixed cut.

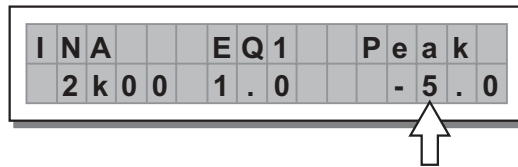

### Peaking

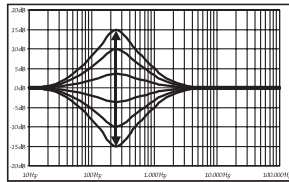

### Low Shelving

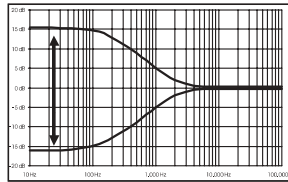

### High Shelving

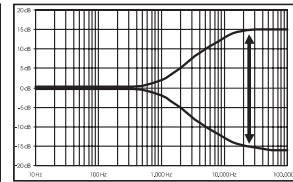

The values can be set in the following ranges:

5-BAND FULL PARAMETRIC EQ				
NAME	TYPE	GAIN	FREQ	WIDTH
Peak	Peaking	±15dB (step 0.5dB)	15.6Hz ~ 16kHz	0.05 ~ 3.00 oct (step 0.05 oct)
LoSh 6	Low Shelving 6dB/oct			
LoSh 12	Low Shelving 12dB/oct			
HiSh 6	High Shelving 6dB/oct			
HiSh 12	High Shelving 12dB/oct			
Notch	Notch Filter	- 45dB (fix)		0.05 ~ 3.00 oct (step 0.05 oct)

#### 5.3.4 Xover

Low-pass and high-pass filters.

Made up of a combination of a low-pass filter and high-pass filter, the crossover allows to divide the audio signal into segments that can be used by the individual section of a sound system (for example High, Mid & Low).



Each Xover has 2 slightly different pages (one for each filter), where the name of the output it affects and the type of filter are shown.

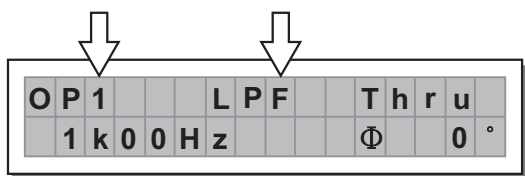

Output 1 - Low Pass Filter

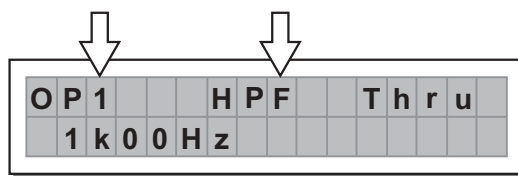

Output 1 - High Pass Filter

### Low Pass Filter

The low-pass filter allows all the frequencies below a specific frequency to pass, whereas it cuts all the frequencies above it.

### High Pass Filter

The high-pass filter allows all the frequencies above a specific frequency to pass, whereas it cuts all the frequencies below it.

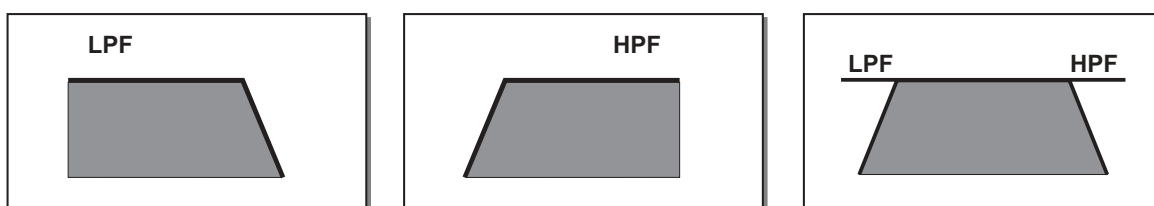

Signal segment obtained with the combination of LPF and HPF.

Each filter has the following editable parameters:

### Type of Filter

Allows to choose three different types of filter and different attenuation slopes:

**Butterworth** (But) at 6, 12, 18 or 24dB per octave,

**Bessel** (Bes) at 12, 18 or 24dB per octave,

**Linkwitz-Riley** (LR) a 12, 24 or 48dB per octave.

By setting the **Thru** value, the filter is disabled and the signal passes without its frequency being altered.

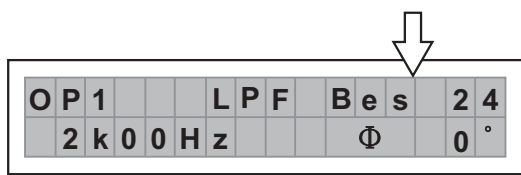

### Crossover Frequency

Allows to choose the filter cutoff frequency.

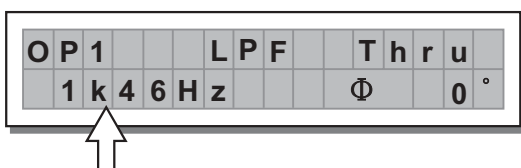

## Phase

Allows fine control (in 5° steps) of the signal's phase.

The effect of this control is summed with that of the Output Polarity function (0° ~ 180°).

In this way it's possible to adjust the phase of each individual output with 5° steps through a full 360°.

**Note:** this control is only in the Low-Pass Filter window.

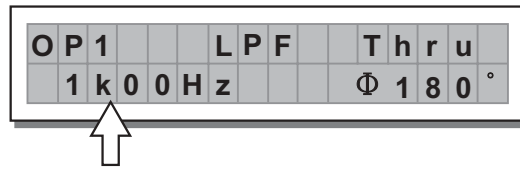

The values can be set in the following ranges:

XOVER					
	NAME	TYPE	SLOPE	FREQ	PHASE
LPF	Thru				0° ~ 180° (Stp 5°)
	But	Butterworth	6, 12, 18, 24 dB/oct	15.6Hz ~ 16KHz	
	Bes	Bessel	12, 18, 24 dB/oct		
	LR	Linkwitz-Riley	12, 24, 48 dB/oct		
HPF	Thru				15.6Hz ~ 16KHz
	Hish 6	Butterworth	6, 12, 18, 24 dB/oct	15.6Hz ~ 16KHz	
	Hish 12	Bessel	12, 18, 24 dB/oct		
	Notch	Linkwitz-Riley	12, 24, 48 dB/oct		

## 5.3.5 Output EQ

Output equalizer with 5 parametric filters.

Also called Channel EQ, allows to alter the tone of each individual output.

The characteristics of quality and programmability are identical to those of the Input Equalizer and enable this unit to be used extremely effectively and flexibly.

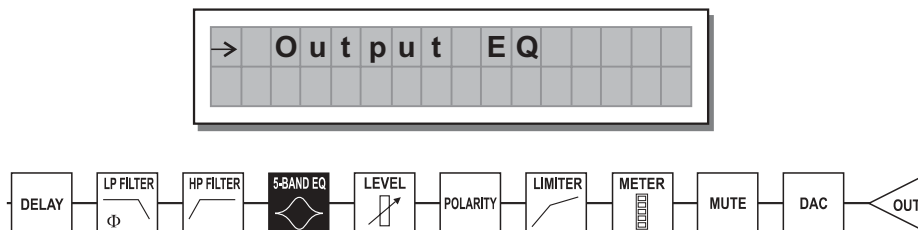

Each equalizer has 5 pages (one per filter), indicating the name of the output it effects and the number of the filter.

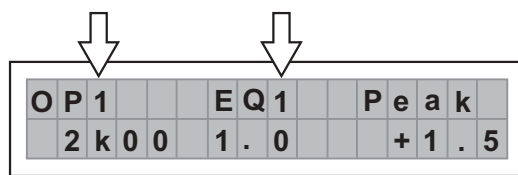

Example: Output 1 - Filter 1

Since technical specifications and editing fields of the Output EQ are identical to those of the Input EQ, please refer to INPUT EQ section for descriptions.

### 5.3.6 Output Gain

Output level control

Allows to adjust the signal level of each individual output.



Editing values are between **+6dB ~ -30dB, with 0.5dB steps.**

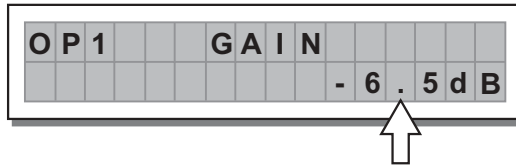

**Note:** The level of each output is shown by the respective OUTPUT LEVEL LED ladder. To avoid distortion, don't let the red CLIP LED light up. As automatic protection, you can also enable the LIMITER (EDIT menu) on the outputs that require it. In this case, remember that enabling the LIMITER changes the display mode on the relative LED ladder: in fact, the level shown is no longer the absolute output level, but the level of the signal in relation to the LIMITER threshold.

### 5.3.7 Output Pol.

Controls the output's polarity.

Allows to invert the phase of the signal of individual outputs.

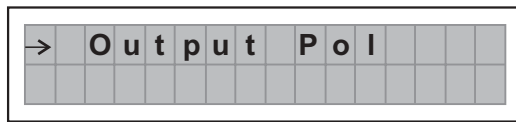

Editing values are:

Normal: leaves the phase unchanged

Reverse: shifts the phase through 180°, inverting it.

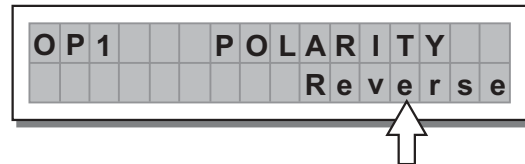
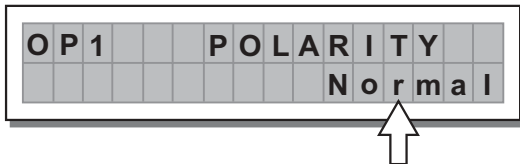

The effect of this control is summed with that of the  $\Phi$  parameter of the LPF filter (**Xover - EDIT** menu), which operates with 5° steps in a range of between 0° and 180°.

In this way it's possible to set the phase of each individual output with 5° steps within a complete 360° revolution, a very useful function when assembling arrays of speaker enclosures, in the control of the interpolation between various enclosures or between sections of the same system.

### 5.3.8 Output Limiter

#### a. Output level limiter

Allows to keep the signal of each individual output within a set level.

Can be used effectively to protect the components of a sound system.

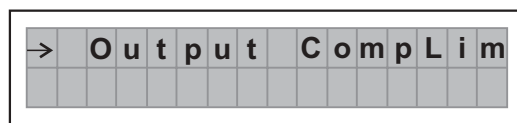

The following editable parameters are available:

## b. Reaction Times

Allows to choose between 3 types of Limiter reaction speed.

In fact, these are attack and release times that are optimised so that the Limiter reacts more or less rapidly when the signal exceeds or drops below the threshold:

- Fast** short times, suited to rapid Limiter operation. Normally more suited to outputs dedicated to high frequencies.
- Normal** intermediate times, suited to the majority of applications. Normally more suited to outputs dedicated to mid frequencies or full-range systems.
- Slow** long times, suited to avoiding rapid repeated level jumps (pump effect). Normally most suited to outputs dedicated to low frequencies.

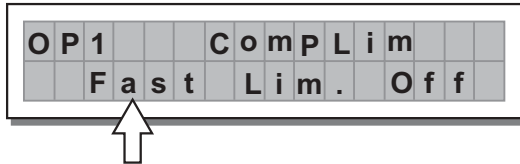

LIMITER	ATTACK	RELEASE
FAST	1 ms	10 ms
NORMAL	8 ms	80 ms
SLOW	45 ms	450 ms

## c. Threshold

Allow to set the level above which the Limiter intervenes (limiting the signal) and below which it leaves the signal unchanged.

The editing values are within the following ranges:

**+19.8dBu ~ -10dBu, with 0.2dBu steps**  
**7.574V ~ 0.245V with variable steps**

The measurement unit can be chosen with the Lim. Thresh. Unit function (**UTILITY** menu - **Units** submenu). The Off value disables the LIMITER, whereas any other value enables it.

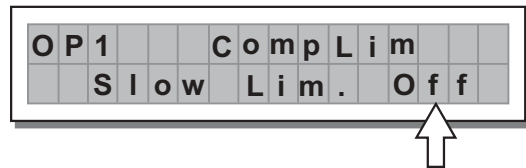
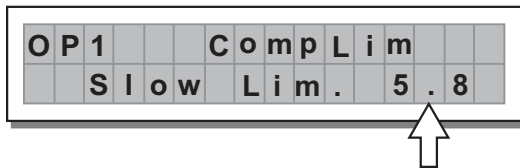

**IMPORTANT!** Enabling the LIMITER on a specific output also changes the way in which the level is displayed on the corresponding **LED ladder**: In fact, the level shown on this ladder is no longer the "absolute" output level, but the level of the signal at -24dB, -12dB, -6dB compared to the **LIMITER's threshold** (orange **LIMIT** LED), no matter what the threshold value is.

## d. Ratio

Allows to set the compression ratio, that is to say how the signal exceeding the threshold has to be reduced.

The editing values are the following: Lim. 20.0 10.0 8.0 6.0 5.0 4.0 3.5 3.0 2.5 2.0 1.7 1.5 1.3 1.1.

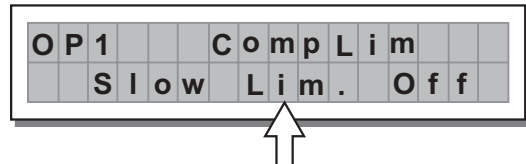
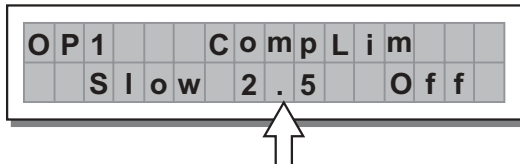

The "Lim." Value corresponds to the maximum compression ratio (all the signal exceeding the threshold is cut) and in this condition the processors acts as a LIMITER.

The other values allow to reduce the signal with a ratio from 1:20.0 (high compression) to 1:1.1 (low compression) in order to obtain different compression effects according to the kind of signal and to the kind of application.

## 5.4 UTILITY Menu

This menu comprises a series of submenus that allow to set a series of system options and access certain utilities, such as the control of the protection against accidental or unauthorized changes:

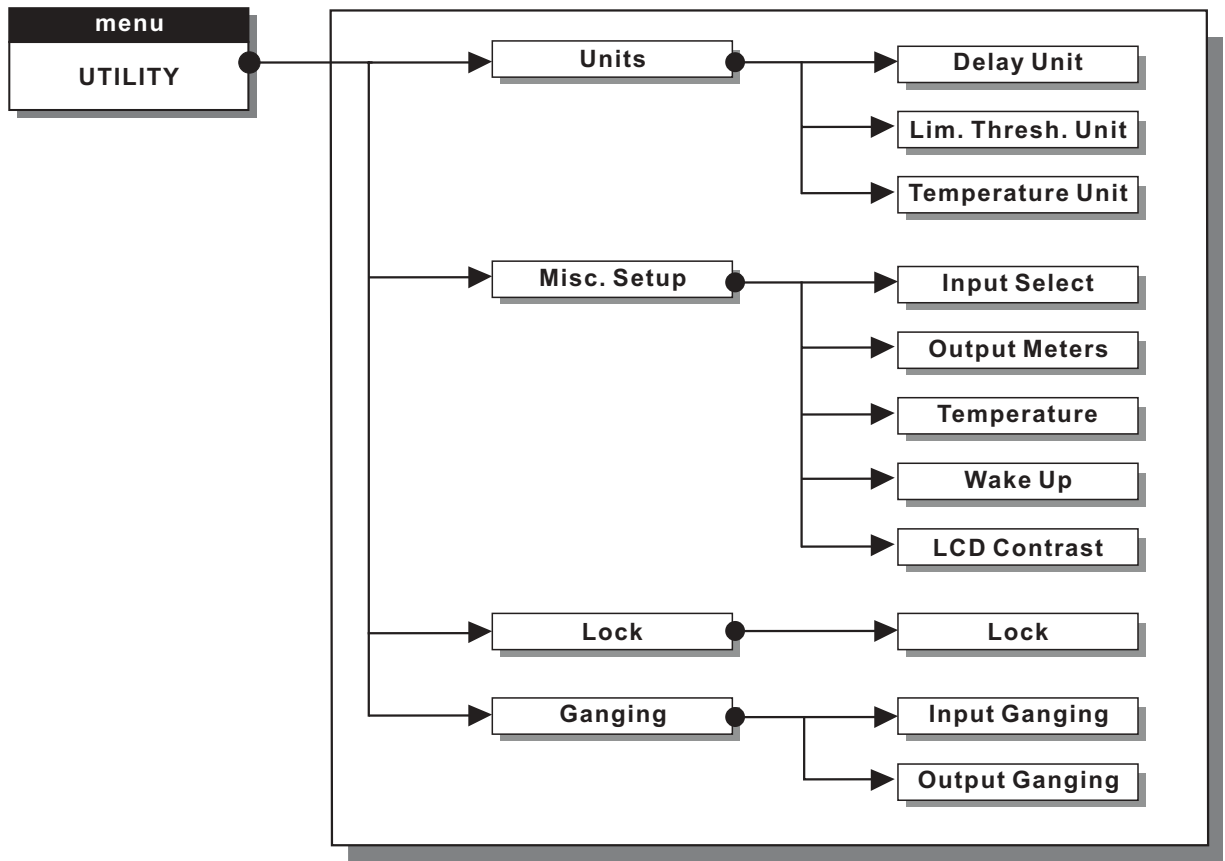

#### 5.4.1 UNITS SUBMENU

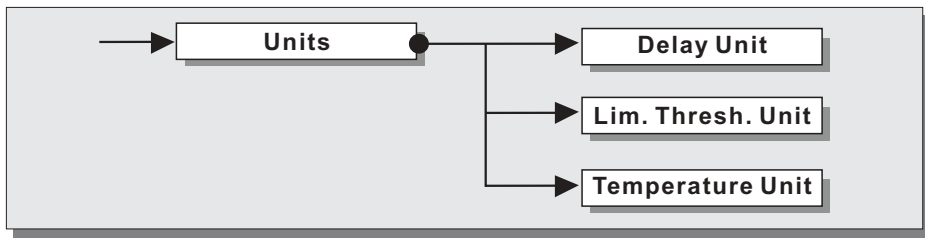

Used this submenu to choose the measurement units to be used with certain functions.

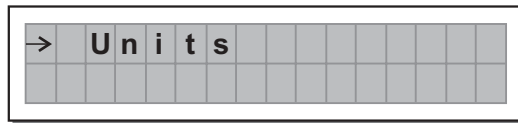

##### a. Delay Unit

Used to set the measurement units in which Delays are expressed (DELAY menu).

The options include: **m** = meters - **mm** = millimeters - **ms** = milliseconds - **us** = microseconds

Measurement units for Input Delay

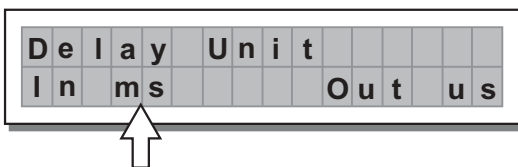

Measurement units for Output Delay

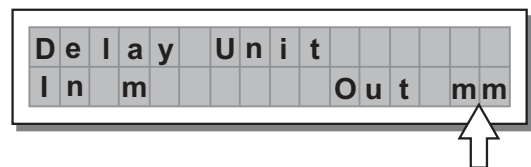

**b. Lim. Thresh. Unit**

Used to set the measurement units for the threshold of the Limiter (**EDIT** menu - **Output Limiter**).  
 The options include: **dBu** = decibel (0 dBu = 0.775 V rms) - **V** = volt

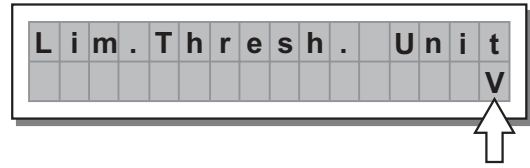
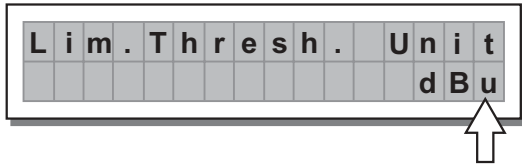

**c. Temperature Unit**

Used to set the measurement units for the Temperature function (**UTILITY** menu - Misc. Setup submenu).  
 The options include: **°C** = degrees Centigrade - **°F** = degrees Fahrenheit

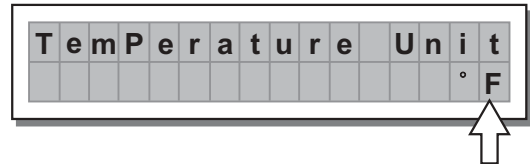
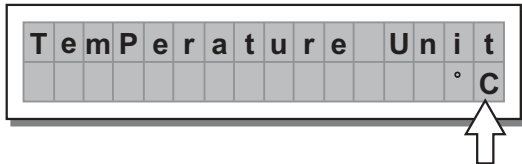

**5.4.2 Misc. Setup Submenu**

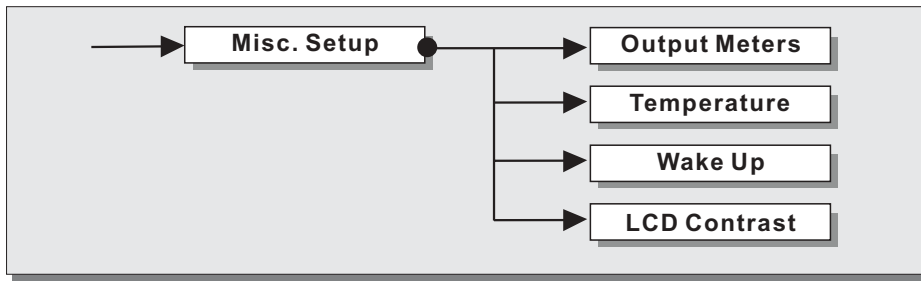

Use this submenu to set a series of system options.

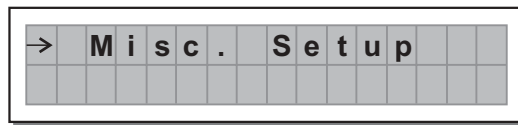

**b. Output Meters**

Used to decide whether to display the outputs signal before or after MUTE.  
 The options include:

**PreMute**  
 the signal is always shown  
 no matter what the MUTE status

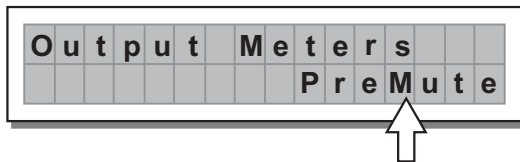

**PostMute**  
 the signal is only shown if  
 the output isn't in MUTE

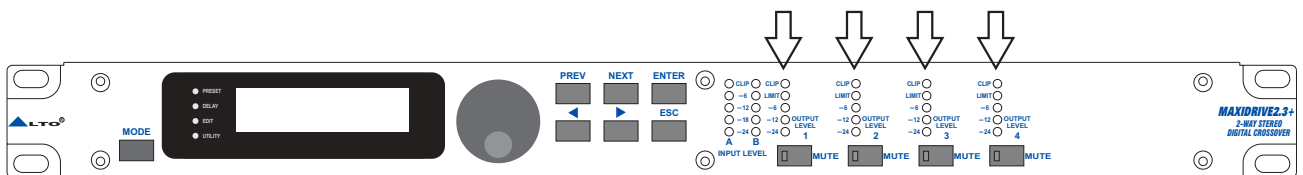
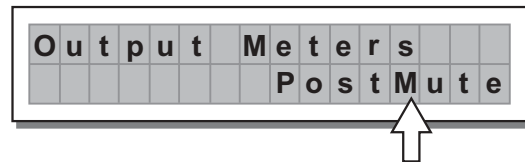



**c. Temperature**

Used to key in the value of the environmental temperature of place of installation.  
 The system uses this value to automatically compensate for the differentials due to the difference speed of sound Transmission according to the air temperature.  
 This allows to set the delays during the sound-check and only have to reset them automatically when necessary (For example during a concert, in the event of big jumps in temperature, etc.).

The editing values are in the following ranges: **+60 °C ~ -30 °C** with 1 °C steps  
**140.0 °F ~ -22.0 °F** with 1.8 °F steps

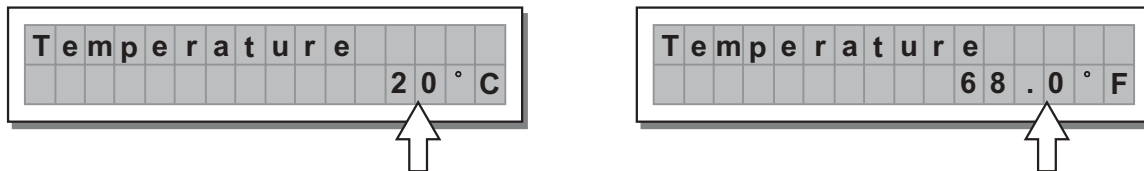

**Note:** the measurement units can be chosen between °C (degrees Centigrade) and °F (degrees Fahrenheit) by means of the Temperature Unit function (UTILITY menu - Units submenu).

**d. Wake Up**

Allows to choose the mode in which MUTE functions are restored when the MAXIDRIVE2.3+ is switched on.  
 The options include:

**Normal**  
 when switched on, the system restores the last MUTE configuration before switching off

**Mute**  
 when switched on, the system automatically sets all the outputs in MUTE

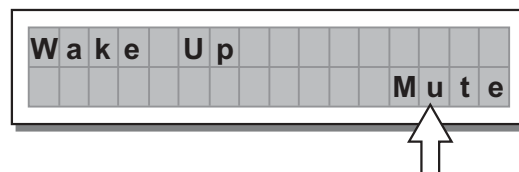
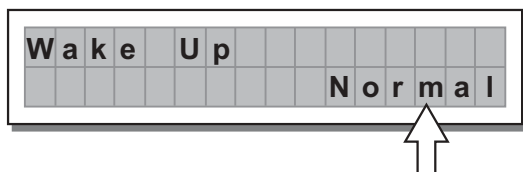

**e. LCD Contrast**

Allows to adjust the Display contrast.  
 The values are in the following range: 0 (minimum contrast) ~ 32 (maximum contrast).

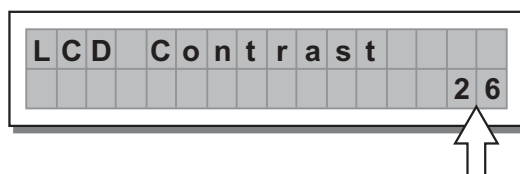

**5.4.3 LOCK SUBMENU**

Used to enable or disable the protection of the system against accidental or unauthorized changes.

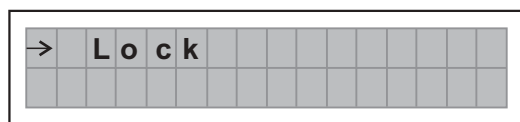
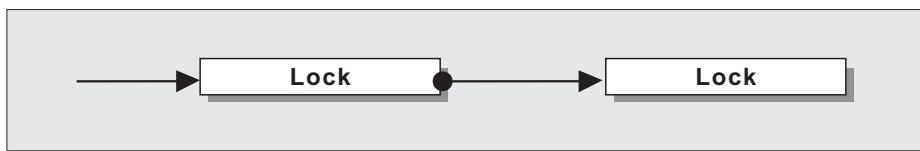

This function is very useful whenever even temporary changes or tampering with the settings stored in the system must be prevented. For example: fixed installations used by several operators (discotheques, clubs, conference halls, etc.), sound system rental, etc.

**How to enable protection**

- First of all, choose the protection mode:  
Two modes are available:

**Total:**

all editing functions are blocked and access to the PRESET menu is disabled

**Partial:**

only the parameters relative to the Inputs can be edited (Delay, Gain, EQ), all other editing functions are blocked and access to the PRESET menu disabled

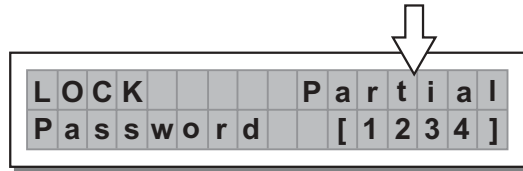
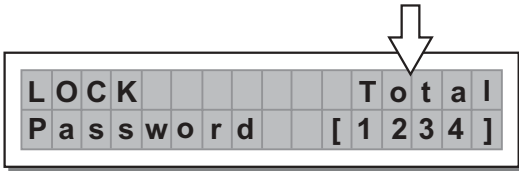

- Then use the ◀ and ▶ keys to access the area in which the **password** is entered.

**IMPORTANT!** The protection cannot be unlocked without the **password!**

So write it down or at least choose a word that is easily remembered.

The password is made up of four alphanumerical characters, obtainable using the ◀ and ▶ keys and editable with the **DIAL**.

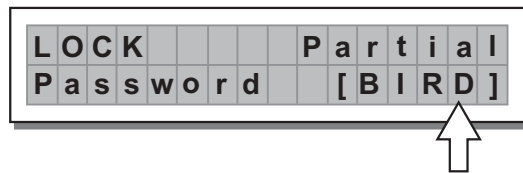
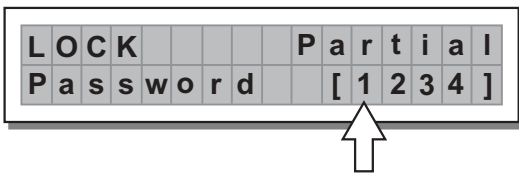

- After entering the password, press **ENTER**.

**Note:** Confirmation is only accepted if the cursor is positioned on one of the passwords four characters. This allows to avoid accidental enabling, without having seen the password.

Protection is enabled and the system takes up default status.

**How to disable the protection**

If the protection is enabled, when the system is in default status (i.e. when none menu **LEDs** are lit and therefore no type of editing is enabled), the following appears on the display:

Total Protection enabled

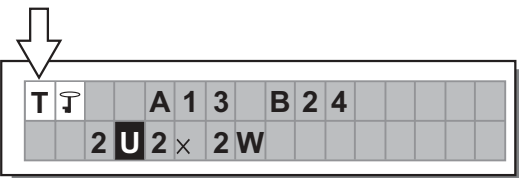

Partial Protection enabled

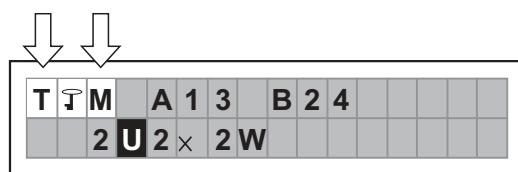
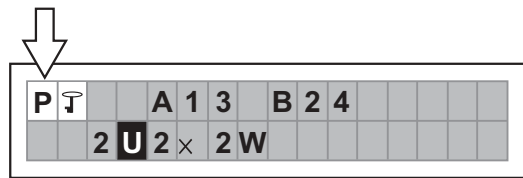

**Note:** alongside the symbol of Total or Partial protection, the letter **M** may also appear. This means that the system is protected, but the PRESET in question has undergone one or more changes that have not yet been stored. You can however switch the system on and off without any problems, as the current settings are kept in the buffer memory. Nevertheless, if this is your work setup, it's advisable to store it in a PRESET.

To unlock the protection:

- Access the **LOCK** submenu.

The display shows the prompt for entering the password to unlock the protection.

The four alphanumeric characters of the password are encrypted.

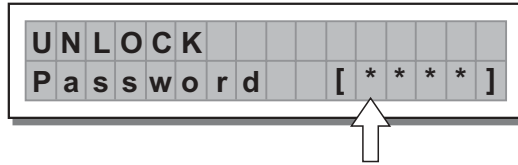

Enter in the **password** using the combination of the ◀ and ▶ keys and the **DIAL**, then press **ENTER**.

**Note:** in the event of an incorrect password, the display prompts again, encrypting all the characters again.

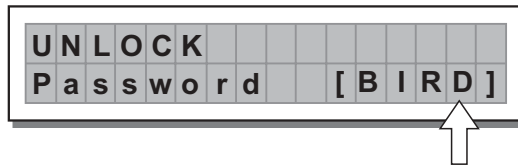

Protection is unlocked and the system enters default status.

#### 5.4.4 GANGING SUBMENU

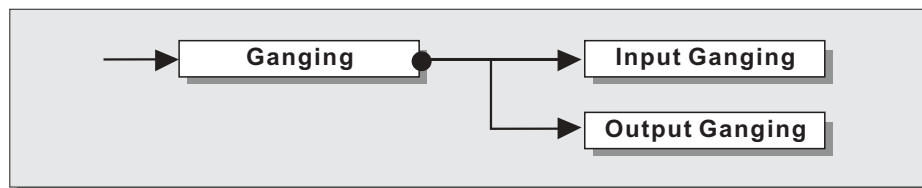

This submenu allows to group together the treatment of similar inputs and/or outputs.

Similar is intended as meaning elements which have the same properties and/or the same structure.

For example, the right and left sections of a stereo system are similar, as they are made up symmetrically of the same quantity and type of elements (the same components for High, Mid and Low frequencies).

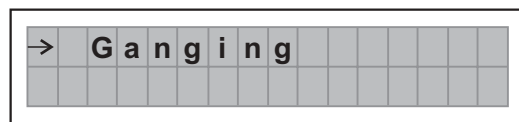

The practical use of the Ganging function consists in the possibility of editing with identical values the parameters of similar elements, carrying out single (instead of double) operations.

For example, it's possible to set the same Delay value or equalization on both inputs with just one operation; or set identical Xover parameters for the various outputs fed to a stereo sound system; or yet again, enable the LIMITER simultaneously on the two outputs dedicated to two mono stage monitors.

The system automatically recognizes incompatible elements contained in the various configurations and only enables the Ganging function where it can effectively be used. Therefore, the Ganging function doesn't have any effect on the MONO setups. The Ganging function can be enabled separately for both groups of input and groups of outputs.

**IMPORTANT:** Precisely for its characteristics, the Ganging function affects the way in which the relative parameters audio are edited or represented:

As soon as Inputs and/or Outputs are ganged, the various menu pages only show the values that can actually be used. This however doesn't mean that the values change immediately. On the contrary, the values remain unchanged (Even if not shown) until new values are entered. Only at that point ganged, Inputs and/or Outputs assume the same value with the just one operation.

For example, even if the display shows that "Input A&B" are ganged in the page with a certain parameter, the value shown remains that of Input A until a new value is entered, as Input B doesn't automatically assume the values of Input A.

To check this:

1. set Input Gangin=Off, load the \*Default\* PRESET, set INA Delay=1 and INB Delay=0;
2. set Input Gangin=On, return to the Input Delay menu: the display shows INA&B Delay=1:
  - a. if you leave the value unchanged and once again set Input Gangin=Off  
going back to the Input Delay menu, the display shows INA Delay=1 and INB Delay=0 ("original" values).
  - b. if you change the value, for example INA&B Delay=3, and you once again set Input Gangin=Off  
going back to the Input Delay menu, the display shows INA Delay=3 and INB Delay=3 ("new" values).

This condition is used to avoid accidental or temporary enabling of the Ganging function from changing the values of all the stored PRESET. The rule can be summed up as follows: "only the values that have to be intentionally changed are changed".

So generally speaking, to avoid contradictions, oversights and confusion between what is shown and what is effectively carried out, it's advisable to enable the Ganging functions before starting to edit a PRESET. Moreover, it's best to make certain to effectively set the required value, manually confirming all the parameters required.

**Note:** The elements in Ganging assume the "new" value as soon as the DIAL changes the status of the "old" value. So, if the value which has to be allocated to the elements in Ganging is the same as the old value, it's necessary to use the DIAL, temporarily change the value (even only by one step) and then go back to the "old" value.

#### a. Input Ganging

Allows to enable/disable Ganging function on the inputs.

The settings are:

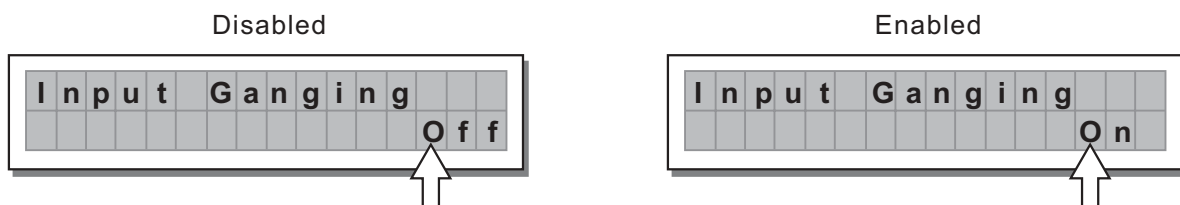

#### b. Output Ganging

Used to enable/disable Ganging function on the outputs.

The settings are:

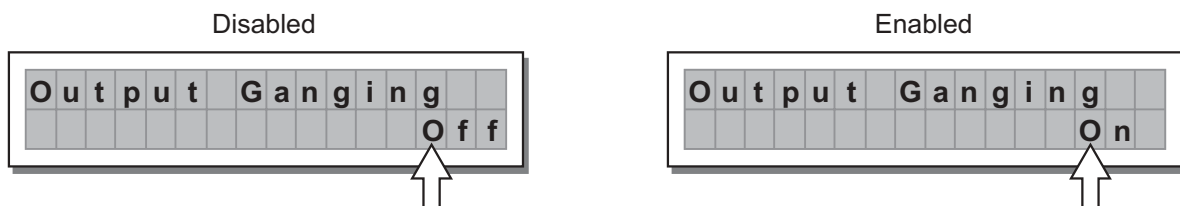

## 6. CONNECTIONS

The following diagrams show the schemes of the recommended cables and some connection examples referred to various system configurations.

### Inputs A & B

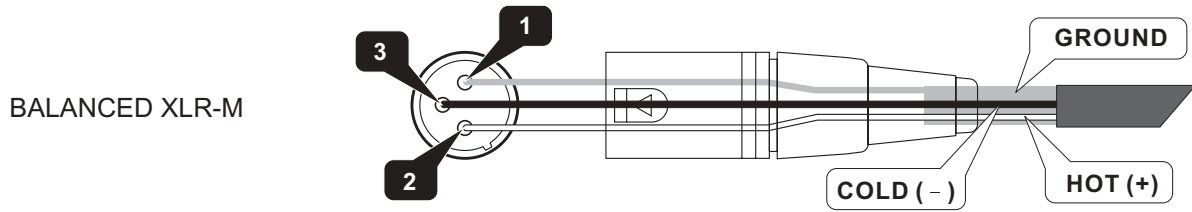

### Inputs A & B

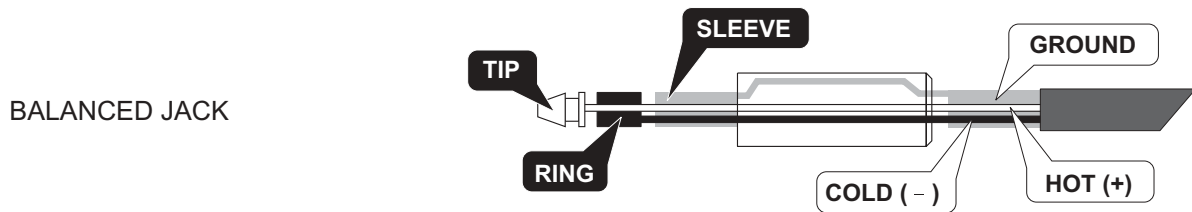

### Outputs 1 ~ 4

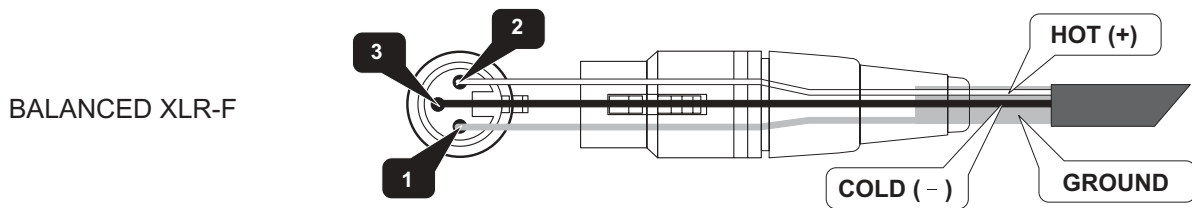

## 7. APPLICATION

The following diagrams show the MAXIDRIVE2.3+'s various system configurations, as if to say, the various input and output hardware combinations.

### 7.1. Factory Preset Configuration

#	Name	Configuration	Configuration
01	DEFAULT	A13 B24	Default preset - routing = 2-WAY STEREO
02	2X2W	A13 B24	2-WAY STEREO
03	2W+MSUB+MAUX	A1 B2 S34	2-WAY MONO with MONO SUB + 2 MONO FULL-RANGE OUT
04	3W+BSUB+MAUX	A12 B3 S4	3-WAY MONO with MONO SUB + 1 MONO FULL-RANGE OUT
05	4W+BSUB	A123 B4	4-WAY MONO
06	4W	A1234	4-WAY MONO with B-SUB + 2 MONO FULL-RANGE OUT

## 7.2 Organization

The following examples will help you well use and connect the unit.

### a. A13 B24 2-WAY STEREO

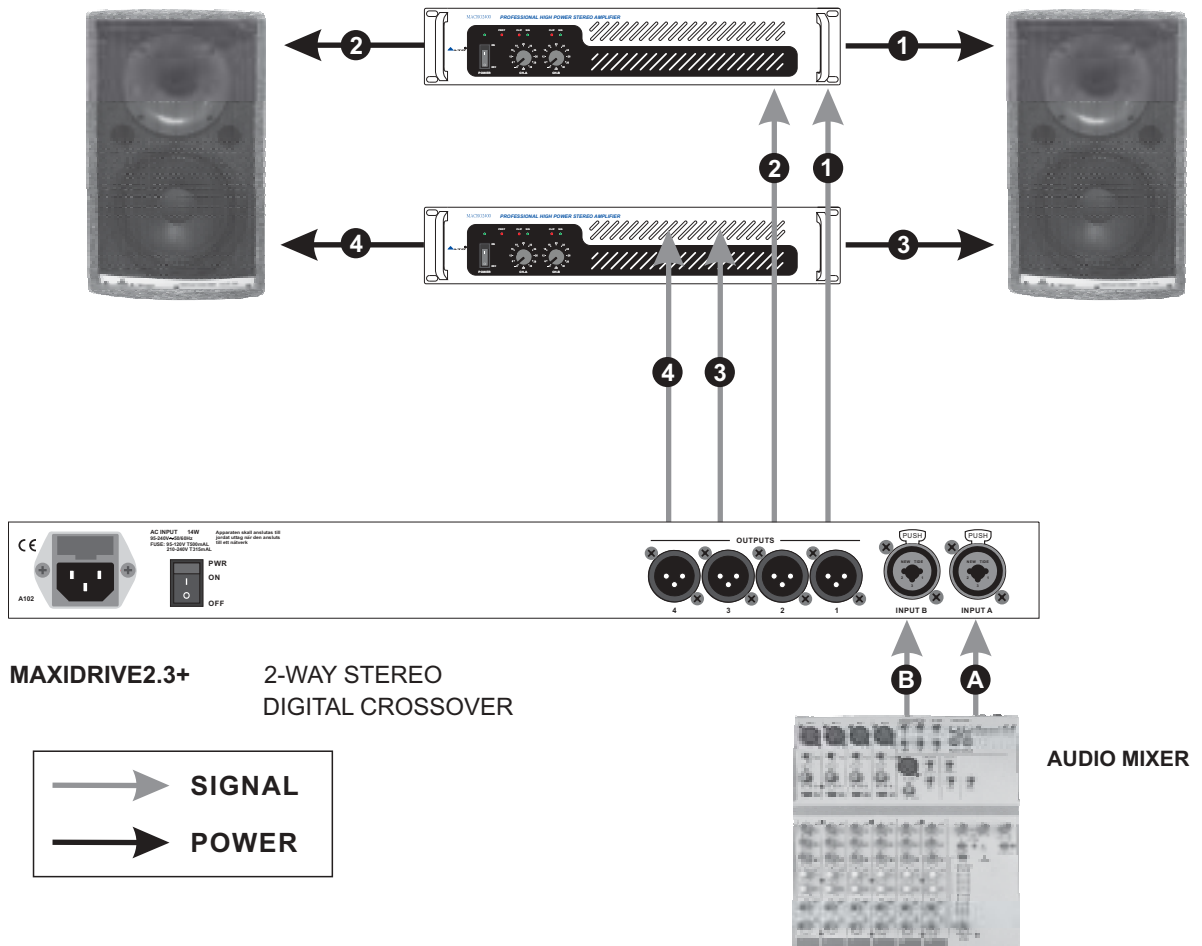
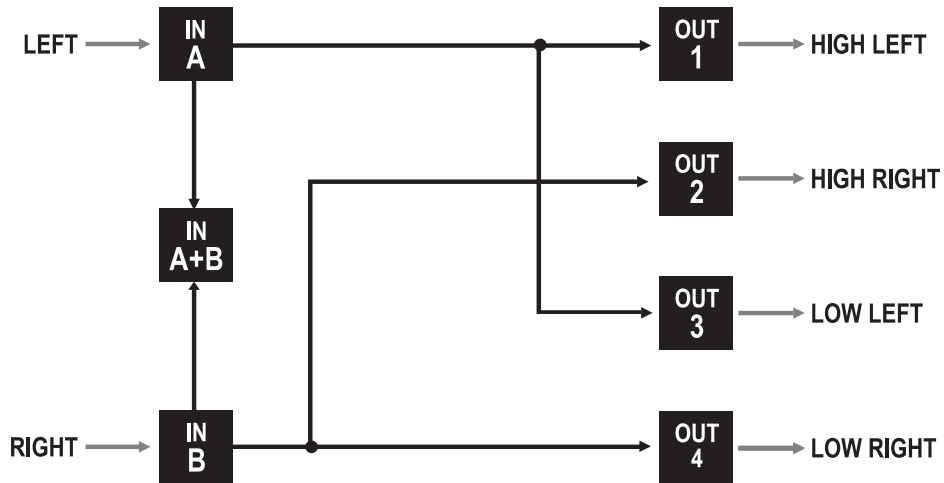

b. A1 B2 S34 2-WAY MONO with MONO SUB + 2MONO FULL-RANGE OUT

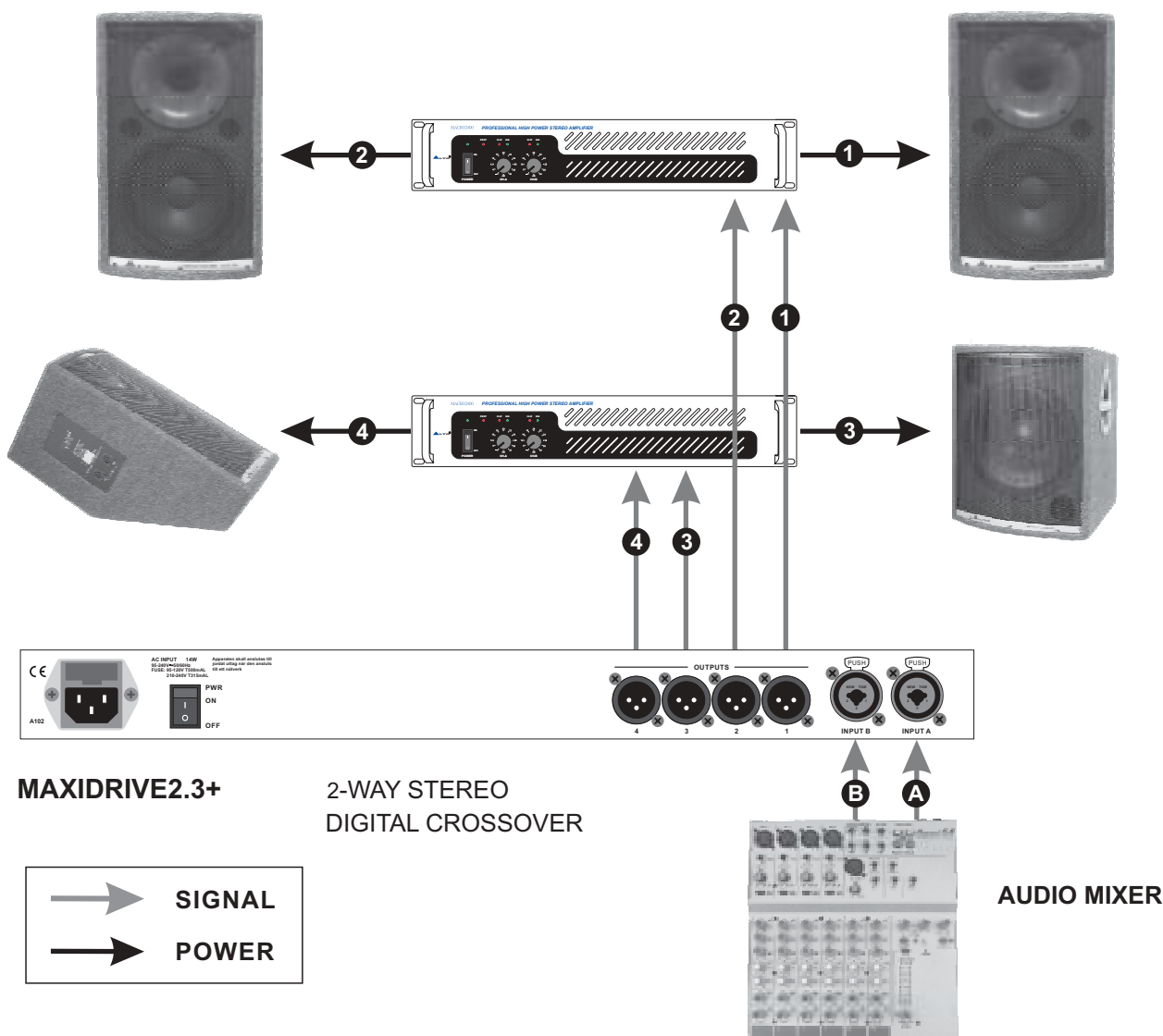
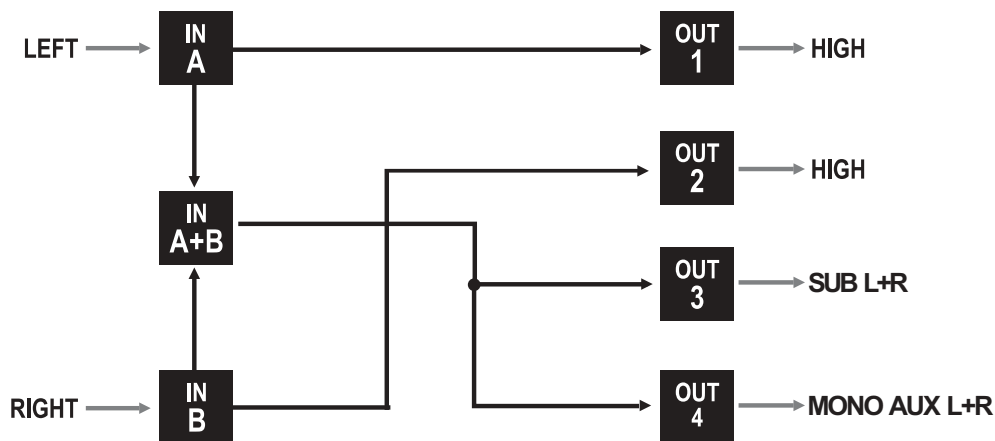

c. A12 B3 S4 3-WAY MONO with MONO SUB +1MONO FULL-RANGE OUT

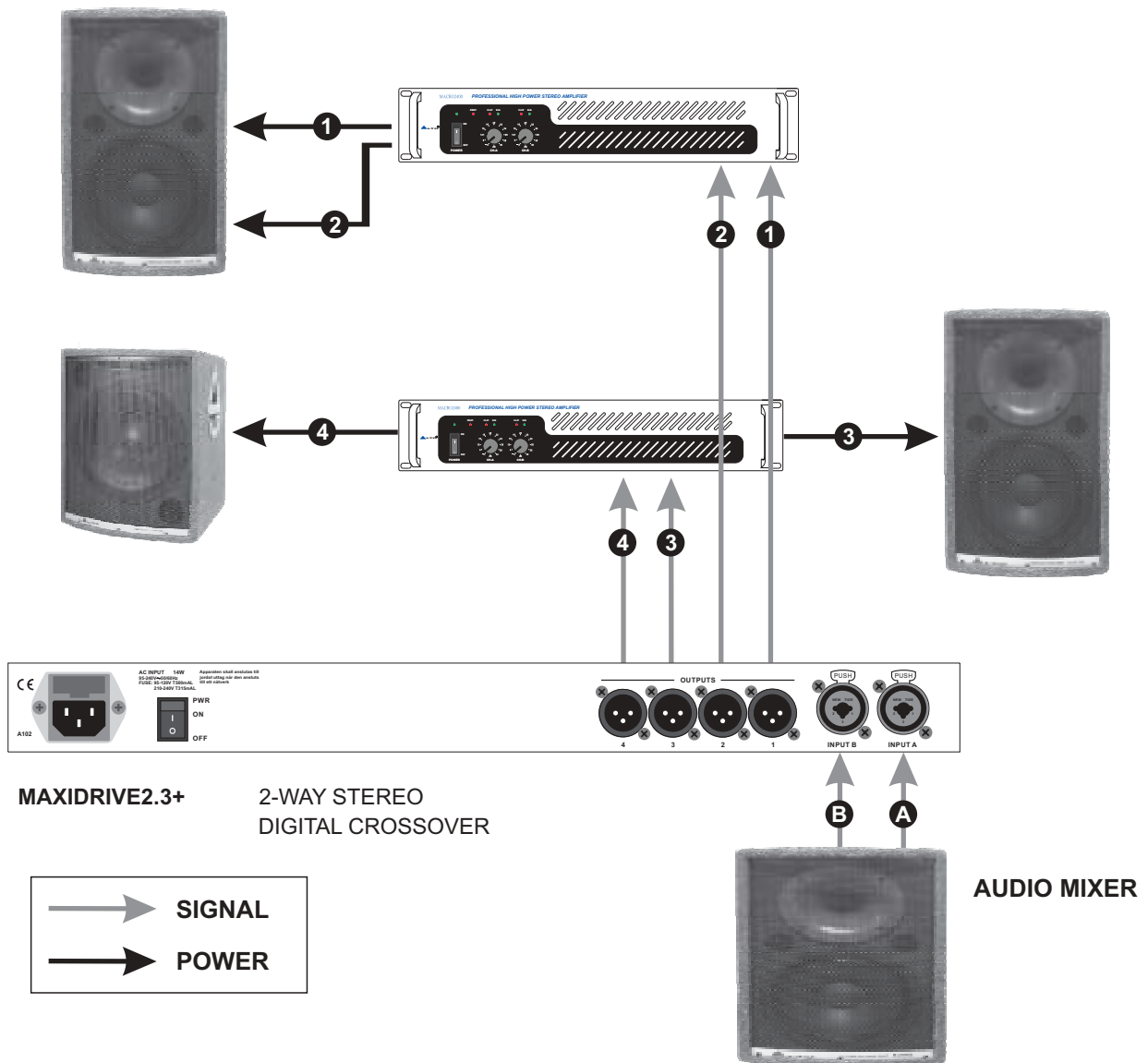
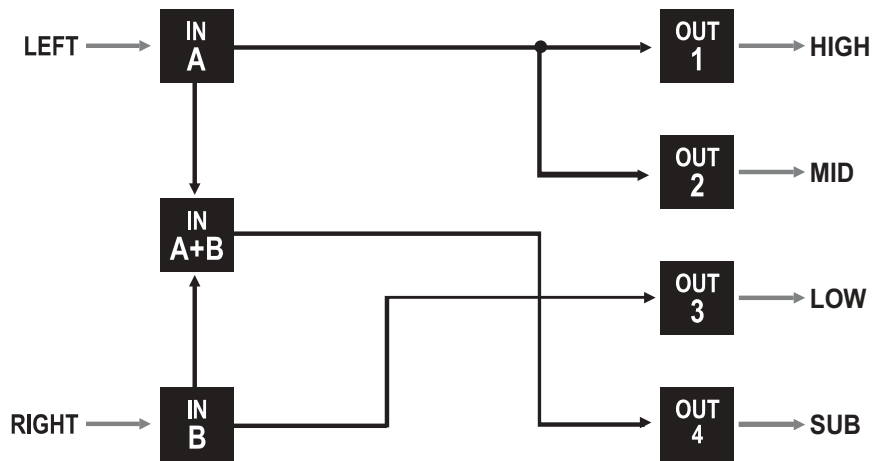



d. A123 B4 4-WAY MONO

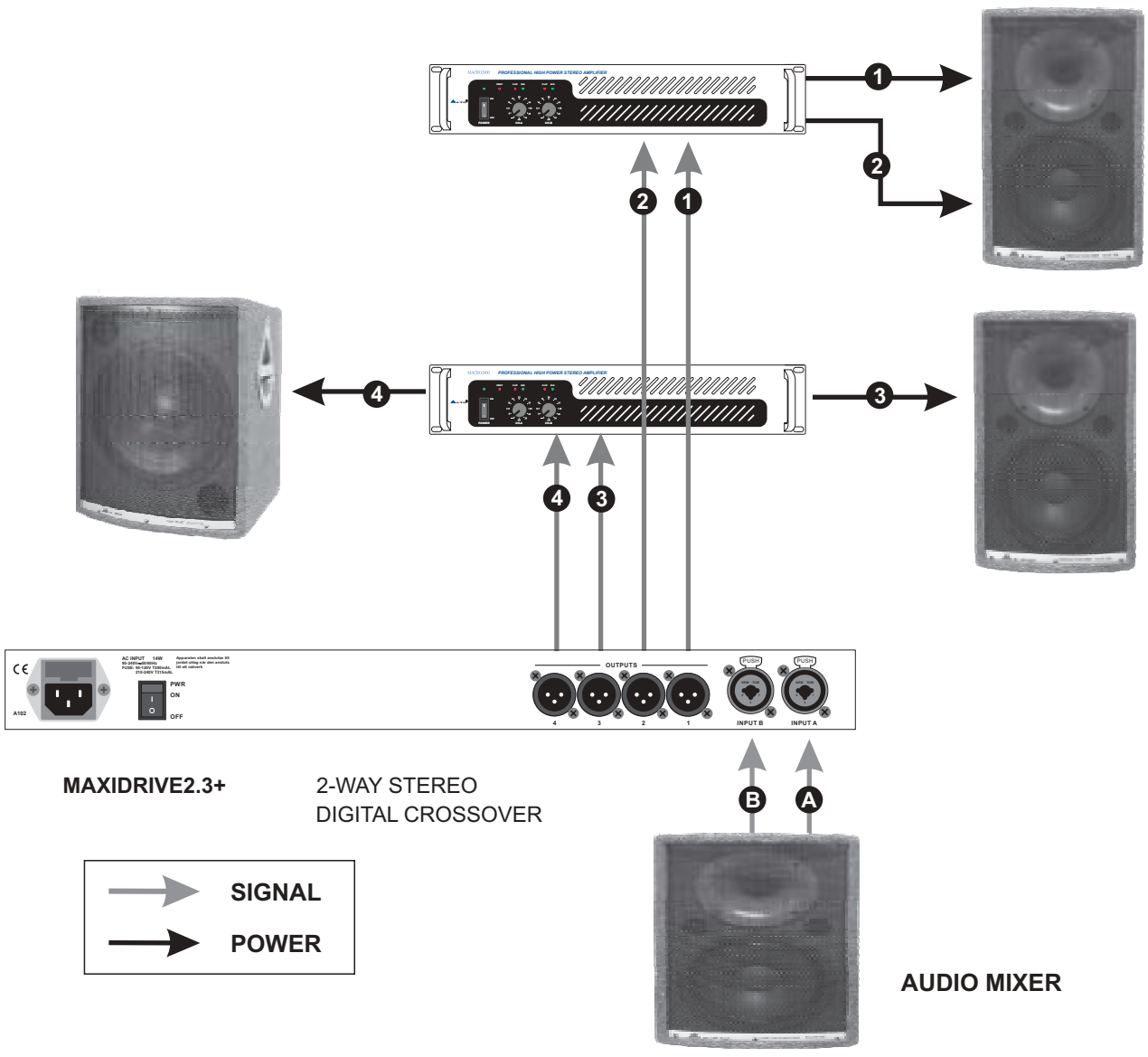
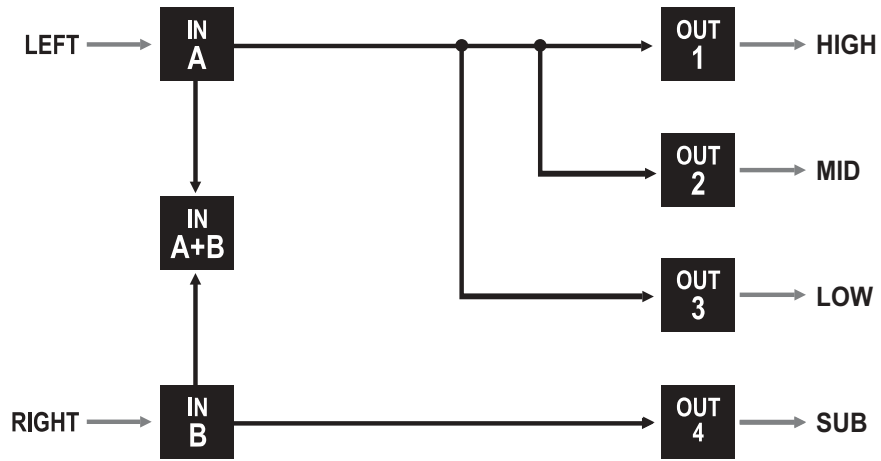

MAXIDRIVE2.3+

2-WAY STEREO  
DIGITAL CROSSOVER



AUDIO MIXER

e. 4W 4-WAY MONO with B-SUB + 2MONO FULL-RANGE OUT

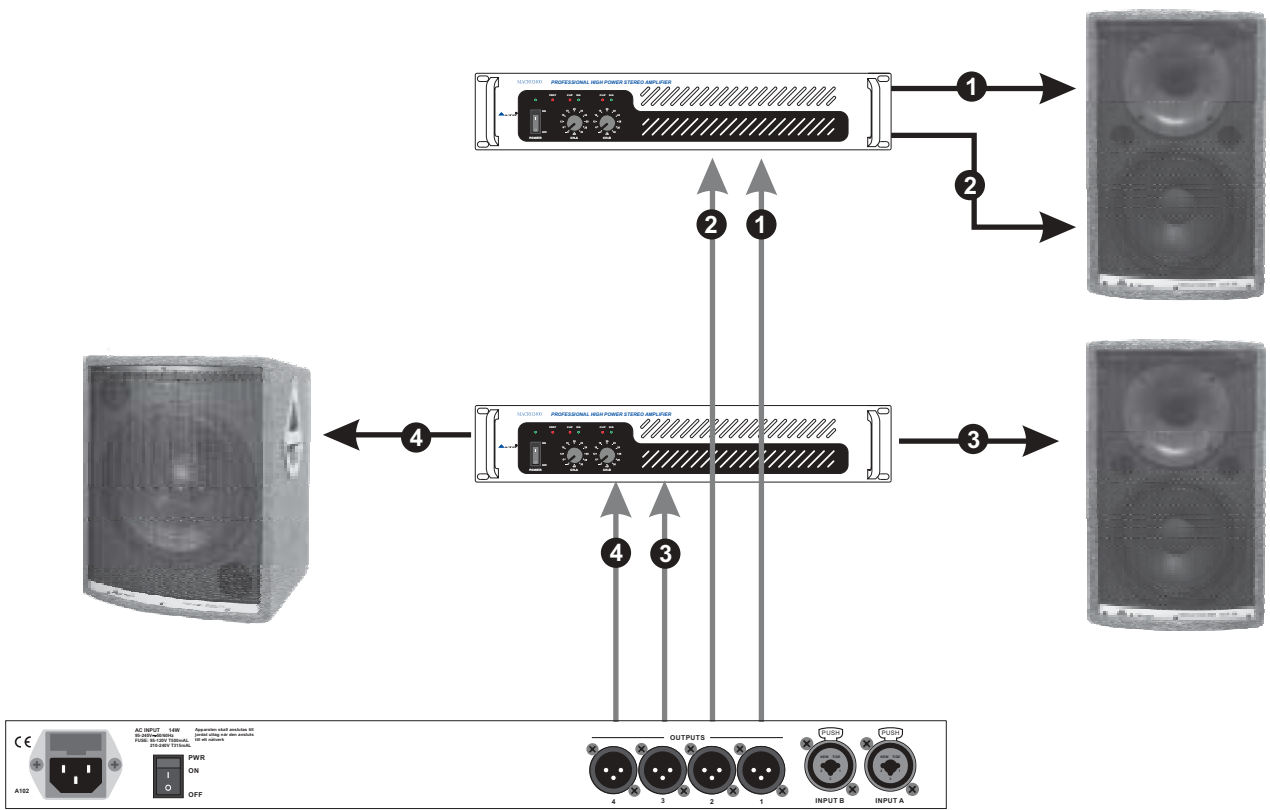
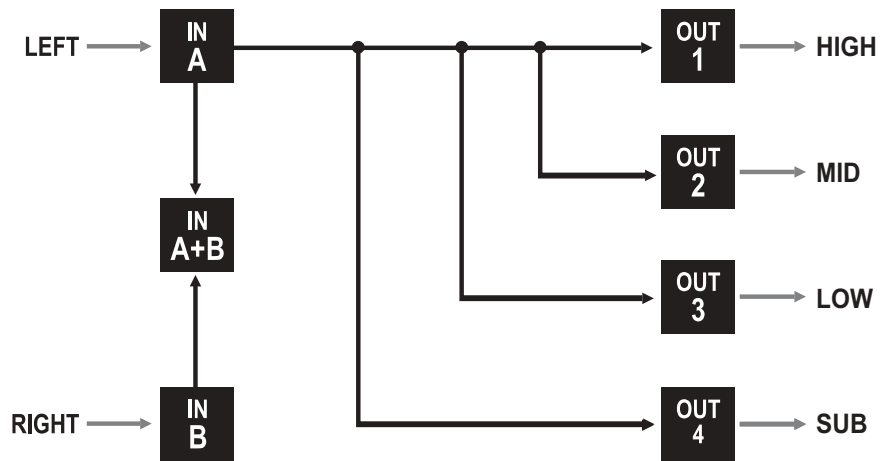

MAXIDRIVE2.3+

2-WAY STEREO  
DIGITAL CROSSOVER

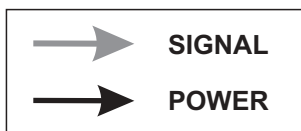

AUDIO MIXER

## 8. TECHNICAL SPECIFICATIONS

<b>INPUT section</b>		
	Connectors	2 x COMBO
	Nominal input sensitivity	0 dB (0.775 V)
	Input Impedance	30kOhm, electronically balanced
	Maximum Input Level	+20dBu
	Input Gain	-30 / +6 dB variable in 0.5 dB steps
<b>Output Section</b>		
	Connectors	4 x XLR-M
	Output Impedance	600 Ohms, electronically balanced
	Nominal Output Level	0 dBu
	Maximum Output Level	+20 dBu
	Output Gain	-30 / +6 dB variable in 0.5 dB steps
<b>DSP Section</b>		
	A/D converters	20 bit
	D/A converters	20 bit
	Internal dynamics	40 bit
	Sampling frequency	48 kHz
<b>Features</b>		
	Configuration	2-WAY STEREO, 2,3,4 - WAY MONO
	Crossover Filters Type	Bessel, Butter worth or Linkwitz- Riley
	Crossover Filters Slope	6, 12, 18, 24, or 48dB per octave
	Delay Step	21 microseconds minimum
	Max Delay time	2621 ms (inputs), 291 ms (outputs)
	EQ filters	Up to 40 maximum (depending on the crossover slope)
	EQ Type	Peak, 6dB Lo-Shelf, 12dB Lo-Shelf, 6dB Hi-Shelf, 12dB Lo-Shelf, Notch
	EQ Gain	+15dB, variable in 0.5dB steps
	EQ Bandwidth	0.05 to 3.00 octaves, variable in 0.05 steps
	EQ freq	15.6 Hz to 16 kHz
	Dynamics	Digital limiter on all the output
	Memories	FACTORY PRESETS are 6 + 64 USER PRESETS
<b>General Performance</b>		
	Frequency Response	20Hz - 20kHz, 0.25dB
	Dynamic range	>117dB 20Hz to 20kHz
	Channel Separation	>100dB 20Hz to 20kHz
	Distortion (THD)	0.05%, 20Hz to 20kHz
	Input Meter	-24dB, -18dB, -12dB, -6dB, CLIP relative to Clip point (+20dBu)
	Output Metering	-24dB, -12dB, -6dB, LIMIT relative to limiter threshold setting, CLIP
<b>General</b>		
	Dimensions	483x44x300 mm
	Weight	4.0 Kg
	Power supply	see label on the unit

## 9. WARRANTY

### 1. WARRANTY REGISTRATION CARD

To obtain Warranty Service, the buyer should first fill out and return the enclosed Warranty Registration Card within 10 days of the Purchase Date.

All the information presented in this Warranty Registration Card gives the manufacturer a better understanding of the sales status, so as to purport a more effective and efficient after-sales warranty service.

Please fill out all the information carefully and genuinely, miswriting or absence of this card will void your warranty service.

### 2. RETURN NOTICE

2.1 In case of return for any warranty service, please make sure that the product is well packed in its original shipping carton, and it can protect your unit from any other extra damage.

2.2 Please provide a copy of your sales receipt or other proof of purchase with the returned machine, and give detail information about your return address and contact telephone number.

2.3 A brief description of the defect will be appreciated.

2.4 Please prepay all the costs involved in the return shipping, handling and insurance.

### 3. TERMS AND CONDITIONS

3.1 ▲LTO warrants that this product will be free from any defects in materials and/or workmanship for a period of 1 year from the purchase date if you have completed the Warranty Registration Card in time.

3.2 The warranty service is only available to the original consumer, who purchased this product directly from the retail dealer, and it can not be transferred.

3.3 During the warranty service, ▲LTO may repair or replace this product at its own option at no charge to you for parts or for labor in accordance with the right side of this limited warranty.

3.4 This warranty does not apply to the damages to this product that occurred as the following conditions:

- Instead of operating in accordance with the user's manual thoroughly, any abuse or misuse of this product.
- Normal tear and wear.
- The product has been altered or modified in any way.
- Damage which may have been caused either directly or indirectly by another product / force / etc.
- Abnormal service or repairing by anyone other than the qualified personnel or technician.

And in such cases, all the expenses will be charged to the buyer.

3.5 In no event shall ▲LTO be liable for any incidental or consequential damages. Some states do not allow the exclusion or limitation of incidental or consequential damages, so the above exclusion or limitation may not apply to you.

3.6 This warranty gives you the specific rights, and these rights are compatible with the state laws, you may also have other statutory rights that may vary from state to state.

**SEIKAKU TECHNICAL GROUP LIMITED**  
**No. 1, Lane 17, Sec. 2, Han Shi W. Road, Taichung, 401 Taiwan**  
**<http://www.altomobile.com> Tel: 886-4-22313737**  
**email: [info@altomobile.com](mailto:info@altomobile.com) Fax: 886-4-22346757**

All rights reserved to ALTO Mobile. Due to continued development in response to customer feedback, product features, specifications and/or internal/external design may be changed without prior notice. No photocopying, translation or reproduction of any part of this user manual is allowed without prior written permission. Copyright © 2004 Seikaku Technical Group Limited.