



SR 2000 IEM SR 2050 IEM

Contents

- Important safety instructions 2
- The SR 2000 IEM and SR 2050 IEM transmitters 4
 - The frequency bank system 4
 - Areas of application 5
- Delivery includes 5
- Product overview 6
 - Overview of the SR 2000 IEM/SR 2050 IEM transmitter 6
 - Overview of the displays 7
- Putting the transmitter into operation 8
 - Setting up the transmitter on a flat surface 8
 - Mounting the transmitter into a 19" rack 8
 - Connecting the antennas 8
 - Connecting an audio source to the input sockets 11
 - Daisy chaining audio signals 11
 - Connecting devices to the output sockets 12
 - Connecting transmitters in a network 12
 - Connecting the mains cable 12
- Using the transmitter 13
 - Switching the transmitter on/off 13
 - Deactivating the lock mode temporarily 14
 - Activating/deactivating the RF signal 14
 - Adjusting the audio channels 14
 - Monitoring the audio signal via headphones 15
 - Synchronizing transmitters and EK 2000 IEM receivers via the infra-red interface 15
- Using the operating menu 18
 - The buttons 18
 - Overview of the operating menu 18
 - Working with the operating menu 20
- Synchronizing the transmitter with an EK 2000 IEM receiver 22
- Cleaning the transmitter 23
- Accessories 23
- If a problem occurs 24
- Specifications 25
- Manufacturer Declarations 26



For more detailed information on the individual sections of this instruction manual, visit the corresponding product page on our website at www.sennheiser.com.

Important safety instructions

1. Read these instructions.
2. Keep these instructions. Always include these instructions when passing the transmitter on to third parties.
3. Heed all warnings.
4. Follow all instructions.
5. Do not use this apparatus near water.
6. Clean only with a dry cloth.
7. Do not block any ventilation openings. Install in accordance with the manufacturer's instructions.
8. Do not install near any heat sources such as radiators, heat registers, stoves, or other apparatus (including amplifiers) that produce heat.
9. Do not defeat the safety purpose of the polarized or grounding-type plug. A polarized plug has two blades with one wider than the other. A grounding type plug has two blades and a third grounding prong. The wide blade or the third prong are provided for your safety. If the provided plug does not fit into your outlet, consult an electrician for replacement of the obsolete outlet.
10. Protect the power cord from being walked on or pinched, particularly at plugs, convenience receptacles, and the point where they exit from the apparatus.
11. Only use attachments/accessories specified by the manufacturer.
12. Use only with the cart, stand, tripod, bracket, or table specified by the manufacturer, or sold with the apparatus. When a cart is used, use caution when moving the cart/apparatus combination to avoid injury from tip-over.
13. Unplug this apparatus during lightning storms or when unused for long periods of time.
14. Refer all servicing to qualified service personnel.
Servicing is required when the apparatus has been damaged in any way, such as power supply cord or plug is damaged, liquid has been spilled or objects have fallen into the apparatus, when the apparatus has been exposed to rain or moisture, does not operate normally, or has been dropped.
15. To completely disconnect this apparatus from the AC mains, disconnect the power supply cord plug from the AC receptacle.
16. **WARNING:** To reduce the risk of fire or electric shock, do not expose this apparatus to rain or moisture.
17. Do not expose this equipment to dripping or splashing and ensure that no objects filled with liquids, such as vases, are placed on the equipment.
18. The mains plug of the power supply cord shall remain readily operable.



Hazard warnings on the rear of the transmitter



The label shown on the left is attached to the rear of the transmitter. The symbols on this label have the following meaning:



This symbol is intended to alert the user to the presence of uninsulated dangerous voltage within the transmitter's enclosure that may be of sufficient magnitude to constitute risk of fire or electric shock.



This symbol is intended to alert the user to the risk of electric shock if the transmitter is opened. There are no user serviceable parts inside. Refer servicing to qualified personnel only.



This symbol is intended to alert the user to the presence of important operating and maintenance instructions in the literature accompanying this transmitter.

Overloading

Do not overload wall outlets and extension cables as this may result in fire and electric shock.

Replacement parts

When replacement parts are required, be sure the service technician uses replacement parts specified by Sennheiser or those having the same characteristics as the original part. Unauthorized substitutions may result in fire, electric shock, or other hazards.

Safety check

Upon completion of any service or repairs to this device, ask the service technician to perform safety checks to determine that the device is in safe operating order.

Danger of hearing damage due to high volumes

This is a professional transmitter. Commercial use is subject to the rules and regulations of the trade association responsible. Sennheiser, as the manufacturer, is therefore obliged to expressly point out possible health risks arising from use.

This transmitter is capable of producing sound pressure exceeding 85 dB(A). 85 dB(A) is the sound pressure corresponding to the maximum permissible volume which is by law (in some countries) allowed to affect your hearing for the duration of a working day. It is used as a basis according to the specifications of industrial medicine. Higher volumes or longer durations can damage your hearing. At higher volumes, the duration must be shortened in order to prevent hearing damage. The following are sure signs that you have been subjected to excessive noise for too long a time:

- You can hear ringing or whistling sounds in your ears.
- You have the impression (even for a short time only) that you can no longer hear high notes.

Intended use

Intended use of the SR 2000 IEM and SR 2050 IEM transmitters includes:

- having read these instructions, especially the chapter "Important safety instructions",
- using the device within the operating conditions and limitations described in this instruction manual.

"Improper use" means using the device other than as described in these instructions, or under operating conditions which differ from those described herein.

The SR 2000 IEM and SR 2050 IEM transmitters

With the SR 2000 IEM and SR 2050 IEM 2-channel/stereo monitoring transmitters, musicians, video and sound amateurs, reporters/broadcasters, etc. can directly monitor the received sound signals without troublesome cables or monitor speakers being required. In addition, the transmitters can also be used for any application where talkback signals are to be transmitted.

Features of the SR 2000 IEM and SR 2050 IEM transmitters:

- Optimized PLL synthesizer and microprocessor technology
- Stereo/mono selection
- HDX noise reduction system
- Switching bandwidth of up to 75 MHz
- Safe configuration of a multi-channel system using the WSM
- Easy setup of a multi-channel system using the Easy Setup Sync function

The frequency bank system

The transmitters are available in 5 UHF frequency ranges with up to 3,000 transmission frequencies per frequency range:

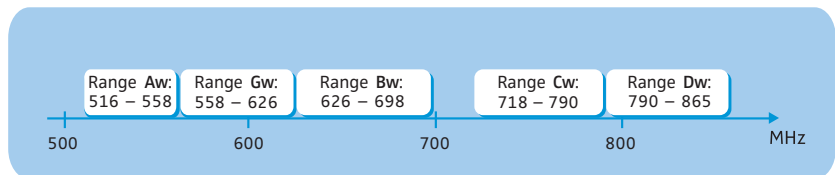

Each frequency range (Aw–Dw, Gw) offers 26 frequency banks with up to 32 channels each:

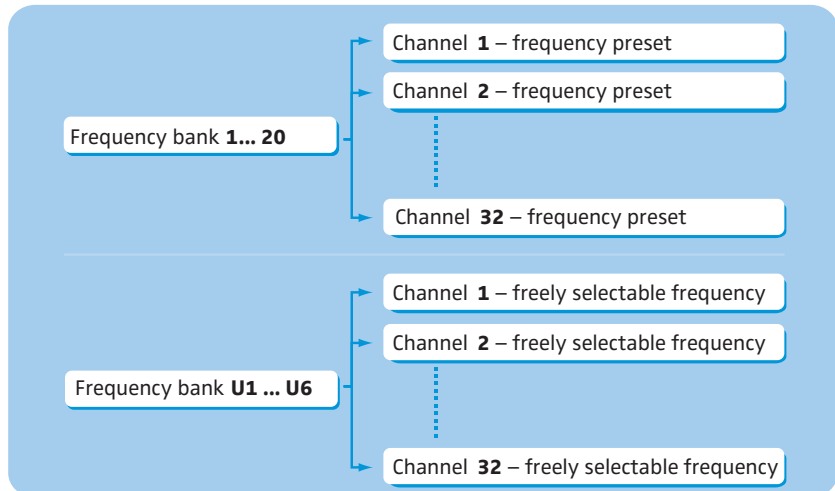

Each of the channels in the frequency banks “1” to “20” has been factory-preset to a fixed transmission frequency (frequency preset). The factory-preset frequencies within one frequency bank are intermodulation-free. These frequencies cannot be changed.

For an overview of the frequency presets, please refer to the supplied frequency information sheet. Updated versions of the frequency information sheet can be downloaded from the corresponding product page on our website at www.sennheiser.com.

The frequency banks “U1” to “U6” allow you to freely select and store transmission frequencies. It might be that these transmission frequencies are **not** intermodulation-free (see page 22).

Areas of application

The transmitters can be combined with the EK 2000 IEM diversity receiver. For more information, visit our website at www.sennheiser.com.

This receiver is available in the same UHF frequency ranges and is equipped with the same frequency bank system with factory-preset frequencies. An advantage of the factory-preset frequencies is that

- a transmission system is ready for immediate use after switch-on,
- several transmission systems can be operated simultaneously on the preset frequencies without causing intermodulation interference.

Delivery includes

The packaging contains the following items:

- 1 SR 2000 IEM transmitter or 1 SR 2050 IEM twin transmitter
- 3 mains cables (with EU, UK and US plug)
- 1 rod antenna (SR 2000 IEM) or 2 rod antennas (SR 2050 IEM)
- 1 instruction manual
- 1 frequency information sheet
- 1 RF licensing information sheet
- 4 self-adhesive device feet

Product overview

Overview of the SR 2000 IEM/SR 2050 IEM transmitter



The SR 2050 IEM twin transmitter has the same operating elements as the SR 2000 IEM transmitter. All information contained in this instruction manual refers to both transmitters.

SR 2050 IEM

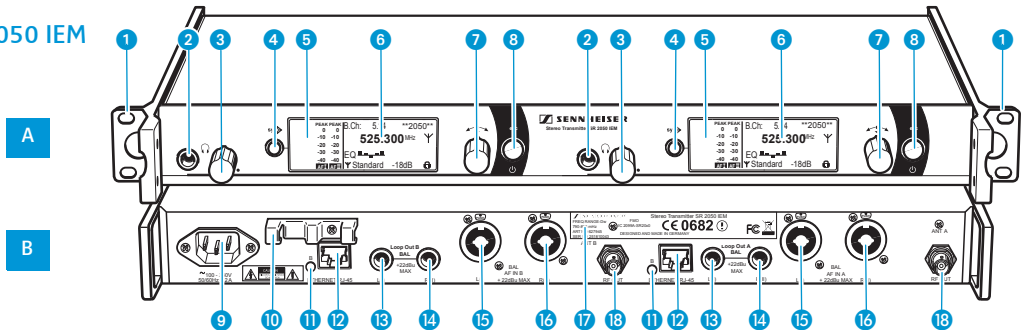

SR 2000 IEM

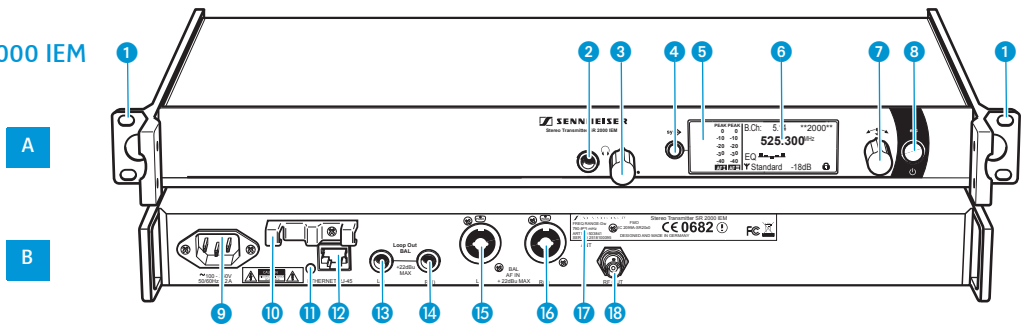

A Operating elements – front panel

- 1 Rack mount "ear"
- 2 Headphone output, 1/4" (6.3 mm) jack socket
- 3 Headphone volume control
- 4 sync button, backlit
- 5 Infra-red interface
- 6 Display panel, backlit in orange
- 7 Jog dial
- 8 **STANDBY** button with operation indication (red backlighting), serves as the ESC (cancel) key in the operating menu

B Operating elements – rear panel

- 9 3-pin mains socket
- 10 Cable grip for power supply DC cable
- 11 LED (yellow) for network activity indication*
- 12 LAN socket (ETHERNET RJ-45)*
- 13 Audio output left (LOOP OUT BAL L(I)), 1/4" (6.3 mm) jack socket*
- 14 Audio output right (LOOP OUT BAL R(II)), 1/4" (6.3 mm) jack socket*
- 15 Audio input left (BAL AF IN L(I)), 1/4" (6.3 mm) jack/XLR-3 combo socket*
- 16 Audio input right (BAL AF IN R(II)), 1/4" (6.3 mm) jack/XLR-3 combo socket*
- 17 Type plate
- 18 Antenna output (RF OUT), BNC socket*

During **mono** operation, the signal from the **left** audio input (1/4" (6.3 mm) jack/XLR-3 combo socket 15) is transmitted.

* These operating elements are available twice on the SR 2050 IEM twin transmitter and are labeled **A** and **B** respectively. **A** designates the left-hand transmitter, **B** the right-hand one (seen from the front).

Overview of the displays

After switch-on, the transmitter displays the standard display.

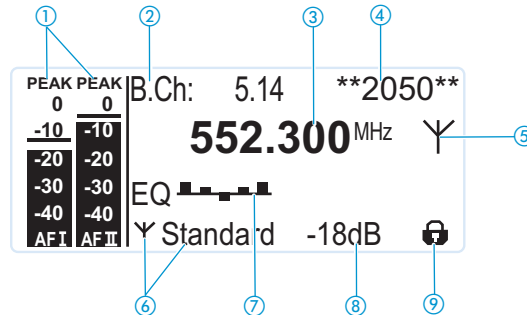

Display	Meaning
① Audio level "AF I" and "AF II" (Audio Frequency)	<p>PEAK PEAK 0 0</p> <p>-10 -10</p> <p>-20 -20</p> <p>-30 -30</p> <p>-40 -40</p> <p>AF I AF II</p> <p>Modulation of the left (AF I) and right (AF II) audio channel with peak hold function</p> <p>When the level displays for audio level show full deflection, the audio input level is excessively high. When the transmitter is overmodulated frequently or for extended periods of time, the "PEAK" display is shown inverted.</p> <p>During mono operation, only the "AF I" display is shown.</p>
② Frequency bank and channel	Current frequency bank and channel number
③ Frequency	Current transmission frequency
④ Name	Freely selectable name of the transmitter
⑤ Transmission icon	RF signal is being transmitted
⑥ Transmission power	Current transmission power
⑦ Equalizer setting	Current equalizer setting
⑧ Input sensitivity	Current input sensitivity for the audio signal available at the audio input sockets BAL AF IN L (I) ⑮ and BAL AF IN R (II) ⑯
⑨ Lock mode icon	Lock mode is activated (see page 14)

Putting the transmitter into operation

Setting up the transmitter on a flat surface



Do not fit the device feet when mounting the transmitter into a 19" rack.

- ▶ Clean the base of the transmitter where you want to fix the device feet.
- ▶ Fit the device feet to the four corners of the transmitter.
- ▶ Place the transmitter on a flat, horizontal surface. Please note that the device feet can leave stains on delicate surfaces.

Mounting the transmitter into a 19" rack

CAUTION!



Risks when rack mounting the transmitter!

When installing the device in a closed or multi-rack assembly, please consider that, during operation, the ambient temperature, the mechanical loading and the electrical potentials will be different from those of devices which are not mounted into a rack.

- ▶ Sure that the ambient temperature within the rack does not exceed the permissible temperature limit specified in the specifications.
- ▶ If necessary, provide additional ventilation.
- ▶ Make sure that the mechanical loading of the rack is even.
- ▶ When connecting to the power supply, observe the information indicated on the type plate. Avoid circuit overloading. If necessary, provide overcurrent protection.
- ▶ When rack mounting, please note that intrinsically harmless leakage currents of the individual mains units may accumulate, thereby exceeding the allowable limit value. As a remedy, ground the rack via an additional ground connection.

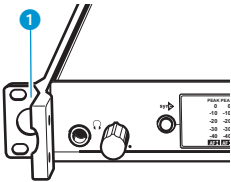

- ▶ Slide the transmitter into the 19" rack.
- ▶ Secure the rack mount "ears" ① to the rack using four screws (not included in the delivery).

Connecting the antennas

You have the following options:

- For professional use, we recommend connecting a remote antenna and, if necessary, using Sennheiser antenna accessories (see next section and the chapter "Connecting several transmitters to a remote antenna" on page 9).
- If the transmitter is to be put into operation without a large amount of installation work, you can:
 - connect the supplied rod antenna to the rear of the transmitter (see page 9) or
 - use the optional GA 3030 AM antenna front mount kit (see page 9).

Connecting and positioning a remote antenna

Use a remote antenna when the transmitter position is not the best antenna position for optimum transmission. You can choose between two antennas (see “Accessories” on page 23):

- A 2003 UHF passive directional broadband antenna
- A 1031 passive omni-directional broadband antenna
- ▶ Use a low-attenuation 50-Ω cable to connect the antenna to the transmitter.
- ▶ If possible, use a short antenna cable and as little connections as possible, since long cables and many connectors lead to an attenuation of the antenna signal.
- ▶ Position the antenna in the same room in which the transmission takes place.
- ▶ Observe a minimum distance of 1 m between the antenna and metal objects (including reinforced concrete walls).



You can connect several transmitters to the same remote antenna (see next section).

Connecting several transmitters to a remote antenna

To make multi-channel systems, you should use the AC 3200 antenna combiner (optional accessory). The AC 3200 allows you to operate up to eight transmitters with a single antenna without virtually any intermodulation.

- ▶ Connect the AC 3200 antenna combiner to the BNC socket 18.

Connecting the rod antenna to the rear of the transmitter

The supplied rod antenna 19 is suitable for all applications where the transmitter is to be put into operation without a large amount of installation work.

- ▶ Connect the rod antenna 19 to the BNC socket 18.

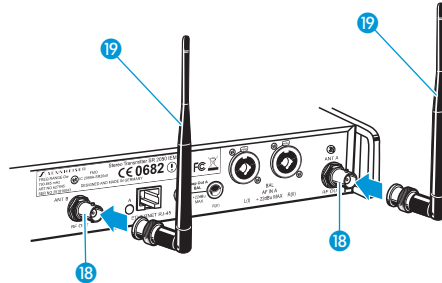

Mounting the antennas to the front of the rack

To mount the antenna connections to the front of the rack when rack mounting the transmitter, you require the GA 3030 AM antenna front mount kit (optional accessory). The GA 3030 AM consists of:

- 2 BNC extension cables (screw-in BNC socket 20 to BNC connector 21),
- 2 antenna holders 22,
- 4 screws,
- 2 washers 23,
- 2 nuts 24.

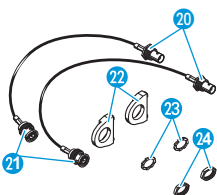

Putting the transmitter into operation

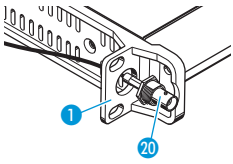

- ▶ Guide the BNC connector 21 of the BNC extension cable through the hole in the rack mount "ear" 1.
- ▶ Connect the BNC connector 21 to the antenna output 18.

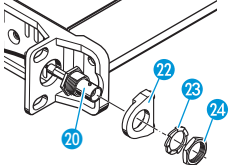

- ▶ Screw the antenna holder 22 to the BNC socket 20 using the supplied washer 23 and nut 24.

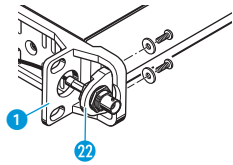

- ▶ Secure the antenna holder 22 to the rack mount "ear" 1 of the transmitter using two of the supplied screws.

If you are using the SR 2050 IEM twin transmitter:

- ▶ Mount the second BNC extension cable in the same way.

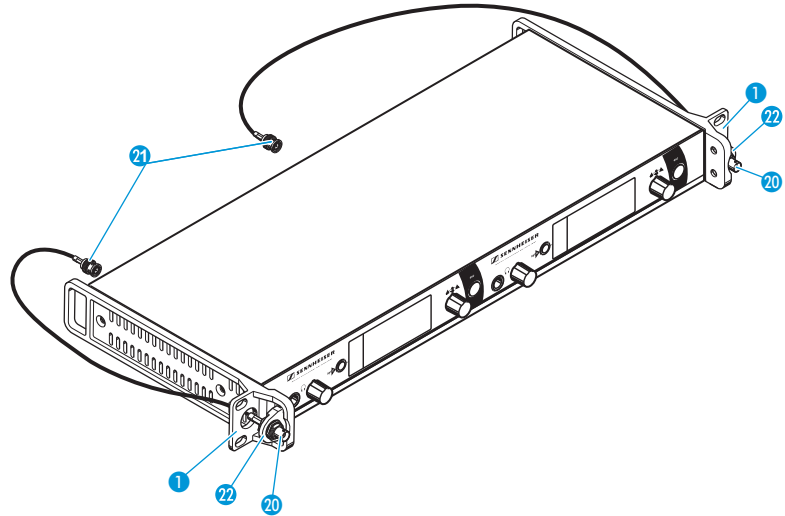

- ▶ Slide the transmitter into the 19" rack.
- ▶ Connect the rod antennas 19 to the two BNC sockets 20.

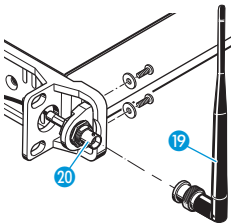

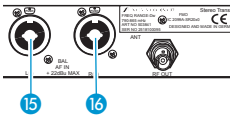

Connecting an audio source to the input sockets

- ▶ Use a suitable cable to connect the output of the audio source (e.g. mixing console) to the 1/4" (6.3 mm) jack/XLR-3 combo socket **BAL AF IN L(I) 15** and/or **BAL AF IN R(II) 16**.
- ▶ Via the operating menu, adjust the transmitter's input sensitivity. The input sensitivity is adjusted via the "Sensitivity" menu item and is common for both inputs.



You can connect several transmitters to the same audio source (see next chapter).

Daisy chaining audio signals

The output sockets **LOOP OUT BAL L 13** and/or **LOOP OUT BAL R 14** allow you to daisy chain a signal that is to be transmitted to all receivers from the mixing console to one transmitter and then to the other transmitters. To do so, proceed as follows:

- ▶ Route a signal from the mixing console to the input socket (in this example: **BAL AF IN R 16**) of transmitter A.

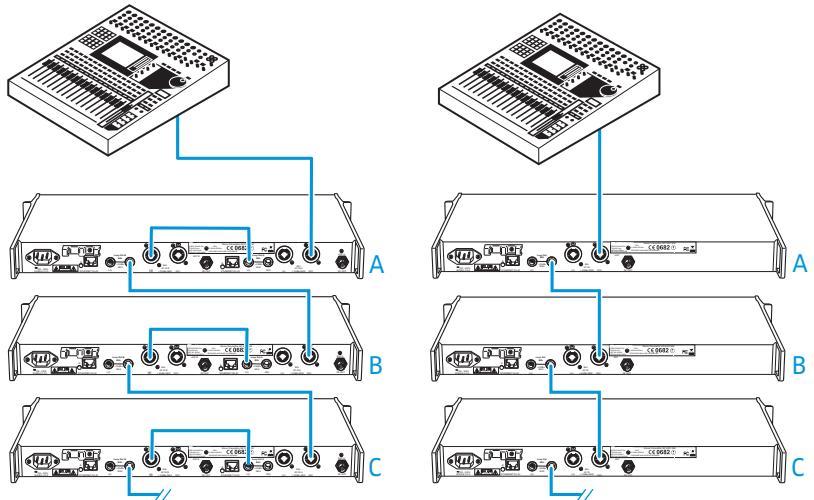

- ▶ Connect the output socket **LOOP OUT BAL R 14** of transmitter A to the input socket **BAL AF IN R 16** of transmitter B.
- ▶ Connect the output socket **LOOP OUT BAL R 14** of transmitter B to the input socket **BAL AF IN R 16** of transmitter C.
- ▶ Repeat for the other transmitters.



The AF output sockets **LOOP OUT BAL L 13** and/or **LOOP OUT BAL R 14** will work only when the transmitter is switched on and powered.

Connecting devices to the output sockets

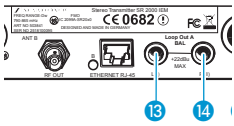

- ▶ Use a suitable cable to connect the audio input of a device (e.g. a mixing console or an additional SR 2000 IEM or SR 2050 IEM) to the output socket **LOOP OUT BAL L(I)** 13 and/or **LOOP OUT BAL R(II)** 14 (see preceding chapter).



The signal received from the AF input sockets **BAL AF IN L(I)** 15 and **BAL AF IN R(II)** 16 is actively buffered and then routed to the output sockets **LOOP OUT BAL L(I)** 13 and **LOOP OUT BAL R(II)** 14. The AF output sockets will therefore work only when the transmitter is switched on and powered.

Connecting transmitters in a network

You can connect several transmitters in a network. The transmitters are remote controlled via a PC running the “Wireless Systems Manager” (WSM) software. This software will assist in the quick and safe configuration of multi-channel systems.



The “Wireless Systems Manager” (WSM) software can be downloaded from the corresponding product page on our website at www.sennheiser.com.

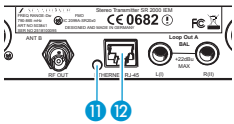

- ▶ Connect a standard network cable (at least Cat 5) to the LAN socket 12 of the transmitter.
- ▶ Connect your transmitters to an Ethernet switch.
- ▶ Connect a PC to the Ethernet switch.
When a transmitter is properly connected to the Ethernet switch or the PC, the yellow LED 11 at the rear of the transmitter lights up.

For further information on network operation, refer to page 22.

Connecting the mains cable

CAUTION!

Damage due to electric current!

If you connect the transmitter to an unsuitable power supply, this can cause damage to the device.

- ▶ Use the supplied mains cable to connect the transmitter to the mains (100 to 240 V AC, 50 or 60 Hz).
- ▶ Ensure a reliable mains ground connection of the transmitter – especially when you are using multi-outlet power strips or extension cables.

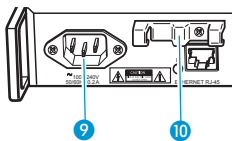

- ▶ Pass the mains cable through the cable grip 10.
- ▶ Connect the mains cable to the mains socket 9.
- ▶ Plug the mains plug into the wall socket.

Using the transmitter

To establish a transmission link, proceed as follows:

1. Switch the transmitter on (see below).
2. Switch the EK 2000 IEM receiver on (see the instruction manual of the receiver).
The transmission link is established.



It is vital to observe the notes on frequency selection on page 22.

If you cannot establish a transmission link between transmitter and receiver:

- ▶ Make sure that transmitter and receiver are set to the same frequency bank and to the same channel.
- ▶ If necessary, read the chapter "If a problem occurs ..." on page 24.

Switching the transmitter on/off

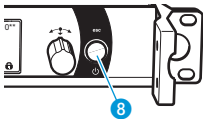

To switch the transmitter **on** (online operation):



- ▶ Briefly press the **STANDBY** button **8**.
The transmitter switches on and the standard display appears.
The transmitter transmits an RF signal and the transmission icon **5** is displayed.

To switch the transmitter to **standby mode**:

- ▶ If necessary, deactivate the lock mode (see page 14)



- ▶ Keep the **STANDBY** button **8** pressed until "OFF" appears on the display panel.
The display panel switches off.



When in the operating menu, pressing the **STANDBY** button **8** will cancel your entry (ESC function) and return you to the standard display.

The **STANDBY** button **8** is backlit in red both during operation and in standby mode.

To switch the transmitter on and to **deactivate the RF signal on switch-on** (offline operation):



- ▶ Press the **STANDBY** button **8** until "RF Mute On?" appears on the display panel.



- ▶ Press the jog dial.
The transmission frequency is displayed but the transmitter does not transmit an RF signal. The transmission icon **5** is not displayed.

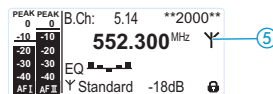





To completely switch the transmitter **off**:

- ▶ Disconnect the transmitter from the mains by unplugging the mains plug from the wall socket.
The backlighting of the **STANDBY** button **8** goes off.

Deactivating the lock mode temporarily

You can activate or deactivate the automatic lock mode via the “Auto Lock” menu item. If the lock mode is activated, you have to temporarily deactivate it in order to be able to operate the transmitter:

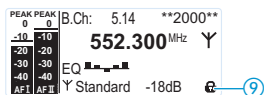

-  ▶ Press the jog dial.
“Locked” appears on the display panel.
-  ▶ Turn the jog dial.
“Unlock?” appears on the display panel.
-  ▶ Press the jog dial.
The lock mode is temporarily deactivated.
 - When you are in the operating menu, the lock mode remains deactivated until you exit the operating menu.
 - When the standard display is shown, the lock mode is automatically activated after 10 seconds.

The lock mode icon  flashes prior to the lock mode being activated again.





Activating/deactivating the RF signal

To **deactivate** the RF signal:

-  ▶ When the standard display is shown on the display panel, press the **STANDBY** button.
“RF Mute On?” appears on the display panel.
-  ▶ Press the jog dial.
The RF signal is deactivated. “RF Mute” flashes in alternation with the standard display and the display is backlit in red.

To **activate** the RF signal:

-  ▶ Press the **STANDBY** button.
“RF Mute Off?” appears on the display panel.
-  ▶ Press the jog dial.
The RF signal is activated and the display backlighting changes from red to orange.

To **deactivate the RF signal on switch-on**:

- ▶ See “offline operation” on page 13.

Adjusting the audio channels

Via the “Mode” menu item, you can adjust the audio channels.

- ▶ Select “Stereo” if you want to transmit two separate audio signals on channel I and channel II (e.g. channel I = audio signal of the presenter/musician, channel II = sum of all audio signals).
This allows the presenter/musician to adjust the balance between the left and right stereo signal on his receiver.
- ▶ Select “Mono” if you only want to transmit an audio signal on one channel. In this case, the signal from the left audio input **BAL AF IN L (I)**  is transmitted.



During mono operation, you have to deactivate the pilot tone evaluation on the EK 2000 IEM receiver in order to ensure that your receiver outputs the same signal on channel I and II.

Monitoring the audio signal via headphones

You can monitor the audio signal via the headphone output **2**.

CAUTION!



Danger of hearing damage!

Listening at high volume levels for long periods can lead to permanent hearing defects.

► Set the headphone volume control **3** to the minimum position before putting the headphones on.

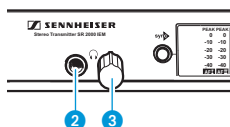

► Set the headphone volume control **3** to the minimum position.

► Connect headphones with a 1/4" (6.3 mm) stereo jack plug to the headphone output **2**.

► Gradually increase the volume and monitor the audio signal with the lowest possible volume.



Synchronizing transmitters and EK 2000 IEM receivers via the infra-red interface

Synchronization allows you to quickly and easily transfer transmitter and receiver settings from one device to the other, especially if you want to configure a multi-channel system. There are two transfer directions:

1. Easy Setup Sync: Transfer from the receiver to one or several transmitters

Once you have performed a frequency preset scan with your receiver, you can use the **Easy Setup Sync** function to transfer unused frequency presets from the receiver to the transmitters via the infra-red interface. In order to configure a multi-channel system, you use the diversity receiver to transfer the first unused channel from the selected frequency bank to the first transmitter and the next unused channel to the second transmitter and so on, thus ensuring that all transmitters of a multi-channel system operate on suitable frequencies.

2. Sync: Transfer from a transmitter to a receiver

Once you have selected and set the desired receiver settings on the transmitter (either manually or using the Easy Setup Sync function), you transfer these settings to a receiver. This configures the receiver and establishes a transmission link between transmitter and receiver.

Via the **"Sync Settings"** submenu, you can adjust the receiver parameters listed below and activate or deactivate their transfer to an EK 2000 IEM receiver.

Setting	Transferred receiver parameter
"Balance"	Current balance setting ("−15"/"+15")
"Squelch"	Current squelch setting ("Off", "5 dB" ... "25 dB")
"Mode"	Current audio mode setting ("Stereo"/"Focus")
"High Boost"	Current treble boost setting ("flat"/"High boost")
"Auto Lock"	Current lock mode setting ("active"/"inactive")
"Limiter"	Current limiter setting ("−18 dB", "−12 dB", "−6 dB", "Off")

When carrying out the **Sync** function, the transmitter's current frequency bank and channel setting as well as the receiver parameters adjusted via the "**Sync Settings**" submenu are transferred to the EK 2000 IEM receiver via the infra-red interface.

Carrying out an Easy Setup Sync or a Sync function

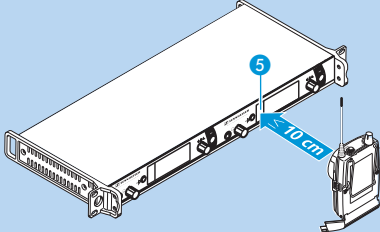
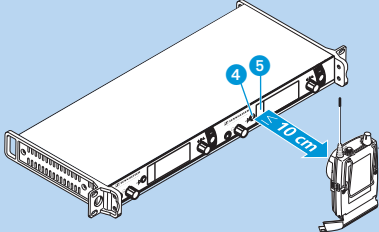

The following assumes that you are using the **Easy Setup Sync** function for setting up a multi-channel system. You can also use the **Easy Setup Sync** function for establishing a transmission link between one transmitter and one EK 2000 IEM receiver.

Easy Setup Sync	Sync
<ul style="list-style-type: none"> ▶ Switch all transmitters and one diversity receiver on. 	<ul style="list-style-type: none"> ▶ Switch your transmitter and your diversity receiver on.
<ul style="list-style-type: none"> ▶ On all transmitters, call up the "Easy Setup" menu item. The text "Easy Setup Sync" and the sync icon appear on the display panels of the transmitters. The RF signal of the transmitters is automatically deactivated. 	<ul style="list-style-type: none"> ▶ Press the sync button 4 on the transmitter. The sync icon appears on the display panels of the transmitter.
<ul style="list-style-type: none"> ▶ Use your diversity receiver to perform a frequency preset scan and select a channel within a frequency bank with a sufficient number of unused channels (see the instruction manual of the receiver). 	<p>–</p>
	
<ul style="list-style-type: none"> ▶ Place the infra-red interface of the receiver (see the instruction manual of the receiver) in front of the infra-red interface 5 of the first transmitter. The next unused frequency preset is transferred from the receiver to the transmitter. As soon as the transfer is completed, the display panel of the transmitter displays the numbers of the transferred frequency bank and channel. Please note that the transmitter does not automatically store the frequency bank and channel setting. 	<ul style="list-style-type: none"> ▶ Place the infra-red interface of the receiver (see the instruction manual of the receiver) in front of the infra-red interface 5 of your transmitter. The parameters adjusted via the "Sync Settings" menu item are transferred from the transmitter to the receiver. In addition, the current frequency bank and channel setting is transferred. When the transfer is completed, "✓" appears on the display panel of the transmitter. The transmitter then switches back to the standard display. The transferred parameters are automatically adjusted and stored by the receiver. The transmission link between transmitter and receiver is now established.

Easy Setup Sync	Sync
<ul style="list-style-type: none"> ▶ Place the infra-red interface of the diversity receiver in front of the infra-red interfaces of the remaining transmitters, one after the other. 	–
<ul style="list-style-type: none"> ▶ Store the frequency bank and channel setting by pressing the jog dial on your transmitters. You can carry out the Sync function (see right-hand column) at a later time to establish a transmission link between transmitters and receivers. <p>OR:</p> <ul style="list-style-type: none"> ▶ Immediately synchronize your receivers with your transmitters by carrying out the Sync function (see right-hand column). This establishes a transmission link between transmitters and receivers. The syn icon in the left lower corner of the transmitter display indicates that the Sync function can be carried out. 	–
–	<p>To cancel the transfer:</p> <ul style="list-style-type: none"> ▶ Press the STANDBY button on the transmitter. <p>“X” appears on the display panel of the transmitter. “X” also appears if no suitable receiver was found.</p>

Using the operating menu

The buttons

Button	Function of the button
Press the STANDBY button 	<ul style="list-style-type: none"> Switches the transmitter on and off Cancels the entry and returns to the standard display (ESC function) Activates/deactivates the RF signal (special function, see page 14)
Press the jog dial 	<ul style="list-style-type: none"> Changes from the standard display to the operating menu Calls up a menu item Enters a submenu Stores the settings and returns to the operating menu
Turn the jog dial 	<ul style="list-style-type: none"> Changes to the next/previous menu item Changes the setting of a menu item

Overview of the operating menu



For more detailed information on the operating menu, refer to the instruction manual of the SR 2000 IEM/SR 2050 IEM which can be downloaded from the SR 2000 IEM/SR 2050 IEM product page at www.sennheiser.com.

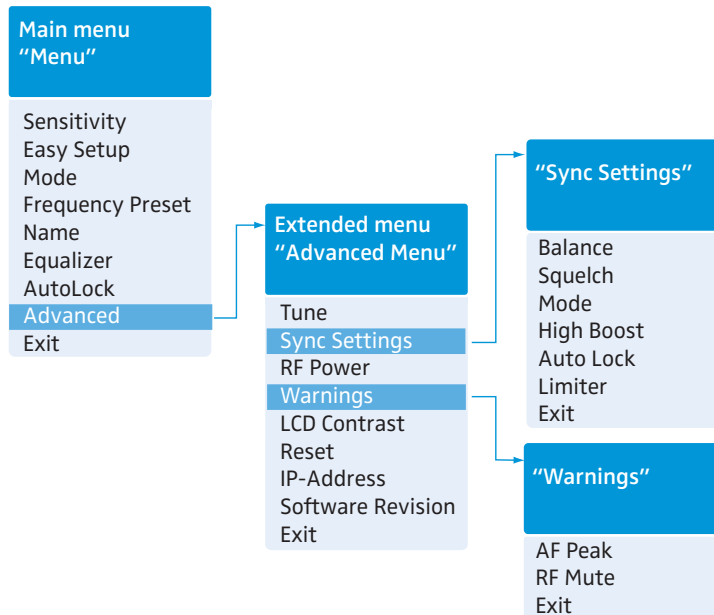

When the standard display is shown on the display panel, you can get into the main menu by pressing the jog dial. The extended menu “Advanced Menu” and the other menus can be accessed via the corresponding menu items.

Display	Function of the menu item
---------	---------------------------

Main menu “Menu”

Sensitivity	Adjusts the input sensitivity
Easy Setup	Deactivates the RF signal and activates Easy Setup Sync (see page 15)
Mode	Selects mono or stereo operation
Frequency Preset	Changes the frequency bank and the channel
Name	Enters the transmitter name
Equalizer	Changes the frequency response of the output signal using a graphic equalizer
AutoLock	Activates/deactivates the automatic lock mode
Advanced	Calls up the extended menu “Advanced Menu”
Exit	Exits the operating menu and returns to the standard display

Extended menu “Advanced Menu”

Tune	<p>Sets the transmission frequencies for the frequency banks “U1” to “U6”</p> <p>Special function: Sets a channel and a transmission frequency for the frequency banks “U1” to “U6”:</p> <ul style="list-style-type: none"> ▶ Select this menu item and call it up by pressing the jog dial 7 until the channel selection appears.
Sync Settings	Adjusts the receiver parameters to be transferred to the receiver and activates/deactivates the transfer (see table on page 15)
RF Power	Adjusts the transmission power
Warnings	Calls up the submenu “Warnings”
LCD Contrast	Adjusts the contrast of the display panel
Reset	Resets the transmitter
IP-Address	Adjusts the IP address of the transmitter
Software Revision	Displays the current software revision
Exit	Exits the extended menu “Advanced Menu” and returns to the main menu

Submenu “Warnings”

Activates/deactivates warnings (color change and warning messages):

AF Peak	Audio overmodulation
RF Mute	RF signal is deactivated
Exit	Exits the submenu “Warnings” and returns to the extended menu “Advanced Menu”

Working with the operating menu



If the lock mode is activated, you have to deactivate it in order to be able to work with the operating menu (see page 14).

By way of example of the “Frequency Preset” menu, this section describes how to use the operating menu.

Changing from the standard display to the operating menu



- ▶ Press the jog dial.
The standard display is replaced by the main menu. The last selected menu item is displayed.

Menu
Squelch
Easy Setup
Frequency Preset
Name
AF Out
Equalizer
Auto Lock
Advanced
Exit

Selecting a menu item



- ▶ Turn the jog dial to change to the “Frequency Preset” menu item.
The current setting of the selected menu item is displayed:

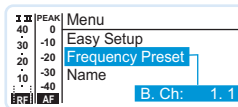

Changing and storing settings

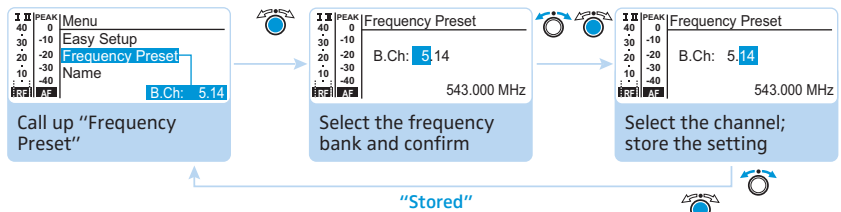

- ▶ Press the jog dial to call up the menu item.



- ▶ Turn the jog dial to set the frequency bank.



- ▶ Press the jog dial to confirm your selection.



- ▶ Turn the jog dial to set the channel.



- ▶ Press the jog dial to store the setting.



By briefly turning the jog dial to the left or right, the display jumps either forwards or backwards to the next menu item or setting. If you turn the jog dial to the left or right and hold it in this position, the display cycles continuously (“fast search” function).

Canceling an entry



- ▶ Press the **STANDBY** button to cancel the entry.
The standard display appears on the display panel.

To return to the last edited menu item:



- ▶ Press the jog dial repeatedly until the last edited menu item appears.

Menu
Squelch
Easy
Frequency Preset
Name
AF Out
Equalizer
Auto Lock
Advanced
Exit

Exiting a menu item



- ▶ Change to the “Exit” menu item.



- ▶ Confirm your selection.
You return to the next higher menu level.

To directly return to the standard display:



- ▶ Press the **STANDBY** button.

Synchronizing the transmitter with an EK 2000 IEM receiver

When synchronizing your transmitter with an EK 2000 IEM receiver, please observe the following:



- ▶ Only use a transmitter and a receiver from the same frequency range (see the type plate on the transmitter and the receiver).
- ▶ Make sure that the desired frequencies are listed in the enclosed frequency information sheet.
- ▶ Make sure that the desired frequencies are approved and legal in your country and, if necessary, apply for an operating license.

Synchronizing the transmitter with an EK 2000 IEM receiver – individual operation

Upon delivery, transmitter and receiver are synchronized with each other. If, however, you cannot establish a transmission link between transmitter and receiver, you have to synchronize the channels of the devices:

- ▶ Carry out the **Easy Setup Sync** function and then the **Sync** function (see page 16).

Alternatively, you can set the channel on the transmitter manually:

- ▶ Make sure that you set the transmitter to the same frequency bank and the same channel as the receiver.

Synchronizing transmitters with EK 2000 IEM receivers – multi-channel operation

Network operation using the WSM

In multi-channel operation, the transmitters are remote controlled via a PC running the “**Wireless Systems Manager**” (WSM) software.



Advantages of controlling the transmitters via the “**Wireless Systems Manager**” (WSM) software:

- Detailed overview of all transmission and receiving channels
- Remote control of all transmitters in the network
- Combination of transmitters of different frequency ranges (see page 4).

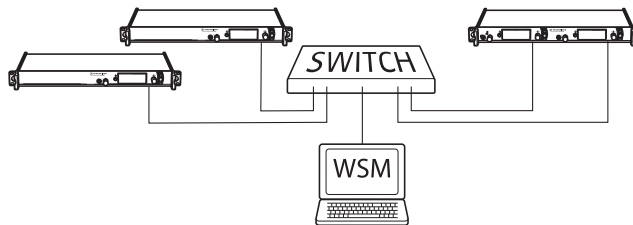

- ▶ Connect your transmitters and your PC in a network (see page 12).
- ▶ Switch your transmitters and your PC on.
- ▶ Launch the “**Wireless Systems Manager**” (WSM) software.
- ▶ To set up your multi-channel system, proceed as described in the instruction manual of the “**Wireless Systems Manager**” (WSM) software.

Operation without network

- ▶ Carry out the **Easy Setup Sync** function and then, for each transmission link, the **Sync** function (see page 16).

Using freely selectable transmission frequencies

You can also freely select the frequencies and store these frequencies in the frequency banks "U1" to "U6".

If you want to use the frequency banks "U1" to "U6":

- ▶ Make sure to use transmitters and receivers from the same frequency range (see page 4 and the type plates of the devices).



To ensure that the desired frequencies are intermodulation-free:

- ▶ Contact your Sennheiser partner (see www.sennheiser.com).
-
- ▶ Set each transmitter to the same frequency bank.
 - ▶ On one of the transmitters, select a channel within this frequency bank (see page 19).
 - ▶ Assign this channel one of the calculated transmission frequencies (see page 19).
 - ▶ Synchronize a receiver with your transmitter (syn▶, see page 16)
- OR
- ▶ Manually set the receiver to the same frequency bank, channel and frequency that you set on the transmitter.
 - ▶ Repeat for the remaining transmitters and receivers as described above.

Cleaning the transmitter

CAUTION!



Liquids can damage the electronics of the transmitter!

Liquids entering the housing of the device can cause a short-circuit and damage the electronics.

- ▶ Keep all liquids away from the transmitter.
-
- ▶ Before cleaning, disconnect the device from the mains.
 - ▶ Use a slightly damp cloth to clean the device from time to time. Do not use any solvents or cleansing agents.

Accessories

Cat. No.	Accessory
004368	GA 3030 AM antenna front mount kit
502048	AC 3200 antenna combiner
500887	A 5000 CP circularly polarized broadband antenna
003658	A 2003 directional broadband antenna
004645	A 1031 omni-directional broadband antenna
087969	Antenna daisy-chain cable, 50 Ω, BNC, 0.25 m
002324	GZL 1019-A1 coaxial cable, type RG 58, BNC to BNC, 1 m

If a problem occurs ...

Problem	Possible cause	Possible solution
Transmitter cannot be operated, "Locked" appears on the display panel	Lock mode is activated	Deactivate the lock mode (see page 14 and page 18).
No operation indication	No mains connection	Check the connections of the mains cable (see page 12).
No RF signal at the receiver	Transmitter and receiver are not on the same channel	Synchronize the transmitter with the receiver (see page 15).
	If "RF Mute" additionally appears on the transmitter display: RF signal is deactivated	Activate the RF signal (see page 14).
Very weak RF signal at the receiver	Transmission range is exceeded	Check the squelch threshold setting on the receiver.
		Reduce the distance between receiver and transmitter.
		Increase the transmission power (see page 19).
	Receiver's squelch threshold is adjusted too high	Reduce the squelch threshold (see the instruction manual of the receiver). Reposition the antennas.
RF signal available, no audio signal at the receiver	No input signal at the transmitter	Check the audio level on the transmitter display (see page 7).
	Very low input signal	Check the audio level on the transmitter display (see page 7), increase the level of the input signal or adjust the input sensitivity (see page 19).
Audio signal has a high level of background noise	Transmitter sensitivity is adjusted too low	Adjust the transmitter sensitivity correctly (see page 19).
Audio signal is distorted	If "AF PEAK" additionally appears on the transmitter display: transmitter sensitivity is adjusted too high	Adjust the transmitter sensitivity correctly.
	Receiver's audio output level is adjusted too high	Reduce the audio output level (see the instruction manual of the receiver).

If a problem occurs that is not listed in the above table or if the problem cannot be solved with the proposed solutions, please contact your local Sennheiser partner for assistance. To find a Sennheiser partner in your country, search at www.sennheiser.com under "Service & Support".

Specifications

RF characteristics

Frequency ranges	516–558, 558–626, 626–698, 718–790, 790–865 MHz (Aw to Dw, Gw, see page 4)
Transmission frequencies	up to 3,000 frequencies, tuneable in steps of 25 kHz 20 frequency banks, each with up to 32 factory-preset channels 6 frequency banks, each with up to 32 user programmable channels
Switching bandwidth	up to 75 MHz
Frequency stability	±10 ppm (–10°C to +55°C)
Antenna output	BNC socket, 50 Ω
RF output power at 50 Ω	typ. 10/30/50 mW (Low/Standard/High), switchable

AF characteristics

Modulation	wideband FM stereo (MPX pilot tone)
Companion system	Sennheiser HDX
Nominal/peak deviation	±24 kHz/±48 kHz
MPX pilot tone (frequency/deviation)	19 kHz/±5 kHz
AF frequency response	25 Hz to 15 kHz
AF input BAL AF IN L (I)/BAL AF IN R (II)	2 x XLR-3/¼" (6.3 mm) jack combo socket, electronically balanced
Max. input level	+22 dBu
THD (at 1 kHz and nominal deviation)	< 0.9%
Signal-to-noise ratio at nominal load and peak deviation	> 90 dB
AF output LOOP OUT BAL L (I)/LOOP OUT BAL R (II)	¼" (6.3 mm) stereo jack socket, balanced

Overall device

Temperature range	–10°C to + 55°C
Power supply	100–240 V~
Current consumption	SR 2000: 0.1 A SR 2050: 0.2 A
Dimensions	approx. 217 x 483 x 43 mm
Weight	SR 2000: approx. 2500 g SR 2050: approx. 2700 g

In compliance with

Europe	 EMC	EN 301489-1/-9
	Radio	EN 300422-1/-2, EN 300454-1/-2
	Safety	EN 60065

Approved by

Canada	Industry Canada RSS 123 IC: 2099A-SR2000 and 2099A-SR2050 limited to 806 MHz
USA	FCC-Part 74 FCC-ID: DMOSR2000 and DMOSR2050 limited to 698 MHz

Connector assignment

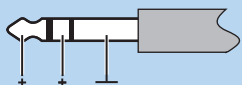
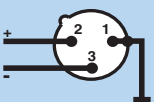
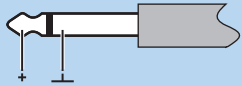
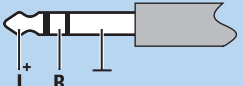
Audio	
1/4" (6.3 mm) stereo jack plug, balanced (Audio In/Loop out)	XLR-3F connector, balanced (Audio In)
	
1/4" (6.3 mm) mono jack plug, unbalanced (Audio In/Loop out)	1/4" (6.3 mm) stereo jack plug for headphone output
	

Manufacturer Declarations

Warranty

Sennheiser electronic GmbH & Co. KG gives a warranty of 24 months on this product.

For the current warranty conditions, please visit our web site at www.sennheiser.com or contact your Sennheiser partner.

In compliance with the following requirements

- RoHS Directive (2002/95/EC)
- WEEE Directive (2002/96/EC)



Please dispose of the transmitter at the end of its operational lifetime by taking it to your local collection point or recycling center for such equipment.

CE Declaration of Conformity

- **CE 0682** 
- R&TTE Directive (1999/5/EC), Low Voltage Directive (2006/95/EC)

The declarations are available at www.sennheiser.com.

Before putting the device into operation, please observe the respective country-specific regulations.

Statements regarding FCC and Industry Canada

This device complies with Part 15 of the FCC Rules and with RSS-210 of Industry Canada. Operation is subject to the following two conditions: (1) this device may not cause harmful interference, and (2) this device must accept any interference received, including interference that may cause undesired operation.

This equipment has been tested and found to comply with the limits for a Class B digital device, pursuant to Part 15 of the FCC Rules. These limits are designed to provide reasonable protection against harmful interference in a residential installation. This equipment generates, uses and can radiate radio frequency energy and, if not installed and used in accordance with the instructions, may cause harmful interference to radio communications. However, there is no guarantee that interference will not occur in a particular installation. If this equipment does cause harmful interference to radio or television reception, which can be determined by turning the equipment off and on, the user is encouraged to try to correct the interference by one or more of the following measures:

- Reorient or relocate the receiving antenna.
- Increase the separation between the equipment and receiver.
- Connect the equipment into an outlet on a circuit different from that to which the receiver is connected.
- Consult the dealer or an experienced radio/TV technician for help.

This class B digital device complies with the Canadian ICES-003.

Changes or modifications made to this equipment not expressly approved by Sennheiser electronic Corp. may void the FCC authorization to operate this equipment.

Before putting the device into operation, please observe the respective country-specific regulations!

Sennheiser electronic GmbH & Co. KG
Am Labor 1, 30900 Wedemark, Germany
www.sennheiser.com

Printed in Germany
Publ. 01/09
529682/A01