

# Oxygen 3 / 3ST

*Broadcast Mixing Console*

## Operating manual

(Rel. 1.2)



Via Caduti Di Sabbiuno 6/F - 40011 Anzola Emilia - Bologna - Italy Tel. +39 051 736555 - Fax. +39 051 736170  
e-mail: [info@axeltechnology.com](mailto:info@axeltechnology.com) - web site: [www.axeltechnology.com](http://www.axeltechnology.com)



# 1 CONTENTS

<b>2</b>	<b>SAFETY INSTRUCTIONS.....</b>	<b>4</b>
<b>3</b>	<b>OXYGEN 3 SERIES - OVERVIEW.....</b>	<b>5</b>
<b>4</b>	<b>OXYGEN 3 – AUDIO INPUT CONNECTIONS .....</b>	<b>6</b>
4.1	<i>CH 1 to 3.....</i>	6
4.2	<i>CH 4 and 5.....</i>	6
4.3	<i>CH 6.....</i>	6
<b>5</b>	<b>OXYGEN 3 ST – AUDIO INPUT CONNECTIONS.....</b>	<b>7</b>
5.1	<i>CH 1, 2 and 3.....</i>	7
5.2	<i>CH 4, 5 and 6.....</i>	7
<b>6</b>	<b>TELEPHONE CONNECTIONS (OXYGEN 3 and 3 ST).....</b>	<b>8</b>
<b>7</b>	<b>OUTPUT CONNECTIONS (OXYGEN 3 and 3 ST).....</b>	<b>9</b>
7.1	<i>MASTER outputs .....</i>	9
7.2	<i>MONITOR OUT and EXT-IN connections (OXYGEN 3 and 3 ST).....</i>	10
7.3	<i>LED-METERS.....</i>	10
<b>8</b>	<b>OXYGEN 3 – INPUT MODULE DESCRIPTION .....</b>	<b>11</b>
8.1	<i>CHANNELS 1 to 6.....</i>	11
<b>9</b>	<b>OXYGEN 3 ST – INPUT MODULE DESCRIPTION.....</b>	<b>12</b>
9.1	<i>CHANNELS 1 to 6.....</i>	12
<b>10</b>	<b>TELEPHONE CHANNELS (OXYGEN 3 and 3 ST).....</b>	<b>13</b>
10.1	<i>ALIGNEMENT OF INPUTS.....</i>	14
<b>11</b>	<b>OUTPUT MODULES DESCRIPTION (OXYGEN 3 and 3 ST).....</b>	<b>15</b>
11.1	<i>MASTER section .....</i>	15
11.2	<i>TALK OVER section .....</i>	15
11.3	<i>MONITOR section .....</i>	15
11.4	<i>LED-METERS .....</i>	17
<b>12</b>	<b>BLOCK DIAGRAM (OXYGEN 3).....</b>	<b>17</b>
<b>13</b>	<b>TECHNICAL SPECIFICATIONS.....</b>	<b>18</b>
13.1	<i>OXYGEN 3.....</i>	18
13.2	<i>OXYGEN 3 ST.....</i>	19
<b>14</b>	<b>WARRANTY .....</b>	<b>19</b>

## 2 SAFETY INSTRUCTIONS

**Read instructions:** Retain these safety and operating instructions for future reference. Adhere to all warnings printed here and on the console power unit. Follow the operating instructions printed in this operating manual.

**Do not remove covers:** Operate the power unit with its covers correctly fitted. Refer any service work to competent technical personnel only.

**Power sources:** Connect the power unit to a mains power only of the type described in this Operating manual and marked on the rear panel. Use the AC cord provided with the console. If the provided plug does not fit into your outlet consult your service agent for assistance.

**Power cord routing:** Route the power cord so that it is not likely to be walked on, stretched or pinched by items placed upon or against it.

**Grounding:** Do not defeat the grounding and polarisation means of the power cord plug. Do not remove or tamper with the ground connection in the power cord.

**Water and moisture:** To reduce the risk of fire or electric shock do not expose the power unit or console to rain or moisture or use it in damp or wet conditions. Do not place containers of liquids on it which might spill into any openings.

**Ventilation:** Do not obstruct the ventilation slots or position the console or power unit where the air flow required for ventilation is impeded.

**Environment:** Protect from excessive dirt, dust, heat and vibration when operating and storing. Avoid tobacco ash, smoke, drinks spillage, and exposure to rain and moisture. If the console becomes wet, switch off and remove mains power immediately. Refer servicing to qualified technical personnel only.

**Servicing:** Switch off the equipment and unplug the power cord immediately if it is exposed to moisture, spilled liquid, objects fallen into the openings, the power cord or plug become damaged, during lightning storms, or if smoke, odour or noise is noticed. Refer servicing to qualified technical personnel only.

**Installation:** Install the console in accordance with the instructions printed in this Operating Manual. Do not connect the output of power amplifiers directly to the console. Use connectors only for their intended purpose.

**Damage:** To prevent damage to the controls and cosmetics avoid placing heavy objects on the control surface, scratching the surface with sharp objects, or subjecting the console to rough handling and vibration.

**Radiation:** To avoid induced noise and interference pickup do not operate the console close to strong sources of electromagnetic radiation such as power supplies, lighting cables and dimmers.

**Cleaning:** Avoid the use of chemicals, abrasives or solvents. The control panel is best cleaned with a soft brush and dry lint-free cloth. Do not leave marking tape stuck to the console for long periods of time as the adhesive can degrade and leave a sticky residue. The faders, switches and potentiometers are lubricated for life. The use of electrical lubricants on these parts is not recommended.

**Transporting:** The console should be transported in the original packing. Protect the control surface from damage during transit. The console is a large and heavy item. To avoid injury ensure adequate man power and precaution when lifting or moving the console.

This manual images could differ a bit from Yr Oxygen 3 real design.

### 3 OXYGEN 3 SERIES - OVERVIEW

**Oxygen 3 quality.** The Oxygen 3 and 3 ST are specially designed On-Air broadcast consoles. Although the design has been carefully budgeted, no compromises has been made in either quality or features. Electronic components have been selected from the best on the market. Faders, potentiometers and switches are by ALPS. Most all of the switches have led indicators and all similar functions are grouped and colour coded, with additional fader knobs with different channel colour coding. Long throw faders give a smooth, repeatable response. Telephone module features a built-in, high quality telephone hybrid. Wood finishing touch are also available on request.

**Self Contained.** The Oxygen 3 and 3 ST are complete and self contained pieces of hardware, requiring no additional items in order to be operated. All relevant functions are built-in, such as Monitor speaker muting and 'On Air lamp' control (facility available on series on the Channel 1 module and, as an option, on Channels 2 and 3).

**Two versions.** Oxygen 3 console is available in two versions: with or without EQ controls on Input channels (respectively called **Oxygen 3** and **Oxygen 3 ST**).

Each console has always two balanced outputs (Out 1 and Out2) plus a number of unbalanced outputs provided on Pin Rca connectors.

Furthermore, while the **Oxygen 3** features **unbalanced LINE inputs** (PinRca connectors), the **Oxygen 3 ST** features electronically **balanced LINE inputs** on Jack 1/4" female connectors.

#### AVAILABLE OPTIONAL ACCESSORIES (OXYGEN 3 and OXYGEN 3 ST)

Item	Description
- WOOD	Wood finishing touch
- CUT	Slider featuring Monitor cut-off facility (to be fitted into Mono channels 2 or 3)
- KSL	ALPS K series sliders (for all input channels)
- ADPT	SubD / 4 XLR adapter for balanced Master outputs



*The Oxygen 3 with food finishing touch option*

## 4 OXYGEN 3 – AUDIO INPUT CONNECTIONS

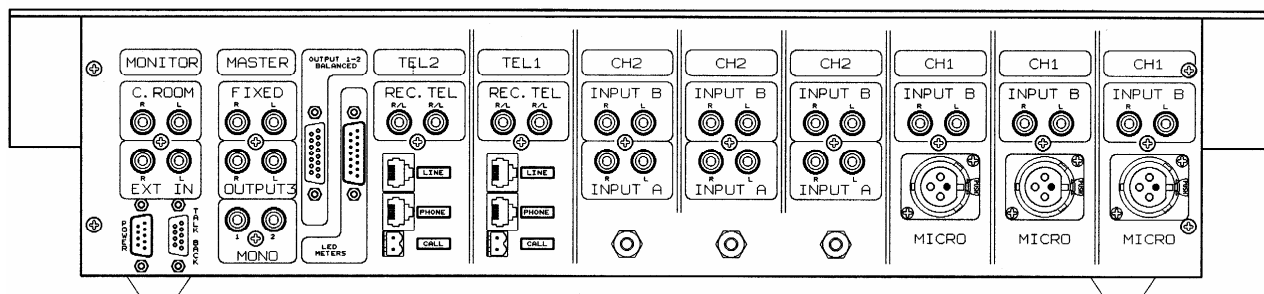

### 4.1 CH 1 to 3

The first three channels feature two selectable inputs:

- INPUT A: input for **MICROPHONE** signal, electronically balanced on XLR female
- INPUT B (PIN RCA): **LINE** input.

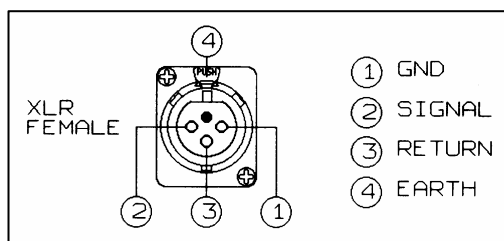

### 4.2 CH 4 and 5

The channels feature two selectable inputs:

- INPUT A (PIN RCA): **LINE** input.
- INPUT B (PIN RCA): **LINE** input

(the A input can be set, if required, as PHONO, too).

### 4.3 CH 6

The channel features two selectable inputs:

- INPUT A (PIN RCA): **PHONO** input  
(*Phono configuration is suitable for record-players, as a RIAA equalization is featured.*)

*NOTE: connection is possible only in unbalanced mode).*

- INPUT B (PIN RCA): **LINE** input

(the A input can be set, if required, as LINE, too).

## 5 OXYGEN 3 ST – AUDIO INPUT CONNECTIONS

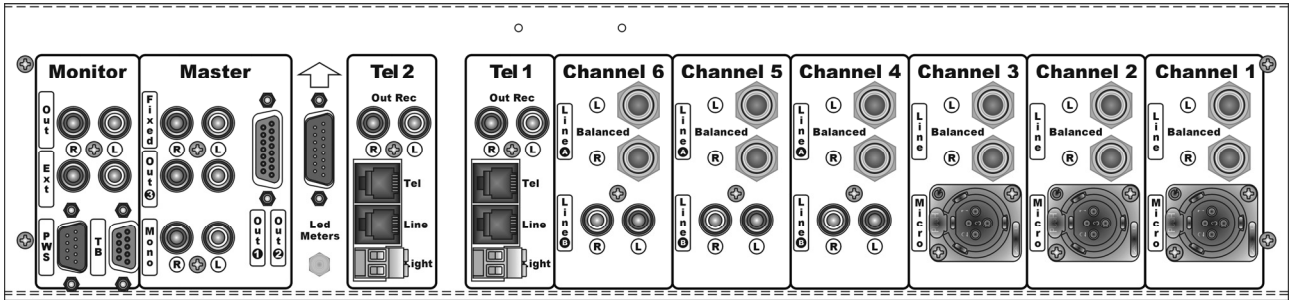

### 5.1 CH 1, 2 and 3

The first three channels feature two selectable inputs:

- INPUT A: stereo **LINE** input electronically balanced on Jack 1/4" female.
- INPUT B: mono input for **MICROPHONE** signal, electronically balanced on XLR female

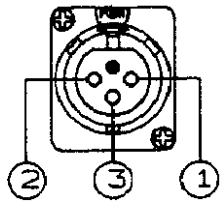

1	Ground
2	Signal
3	Return

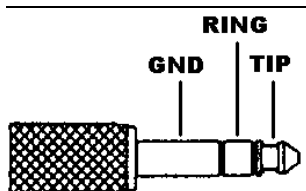

Ground	Ground
Ring	Return
Tip	Signal

### 5.2 CH 4, 5 and 6

The channels feature two selectable stereo inputs:

- INPUT A: **LINE** input electronically balanced on Jack 1/4" female
- INPUT B: **LINE** input unbalanced (PinRca connectors)

NOTE: the Oxygen 3 ST comes from the factory with the **CHANNEL 6 / INPUT B** set as **PHONO** input (i.e. suitable for record-players / turntables). **CHANNELS 4 and 5 / INPUT B** are set by default for **LINE** signals.

However, **Input B configuration** on Channels 4, 5 and 6 may be **altered** via internal jumpers, accordingly to the following scheme:

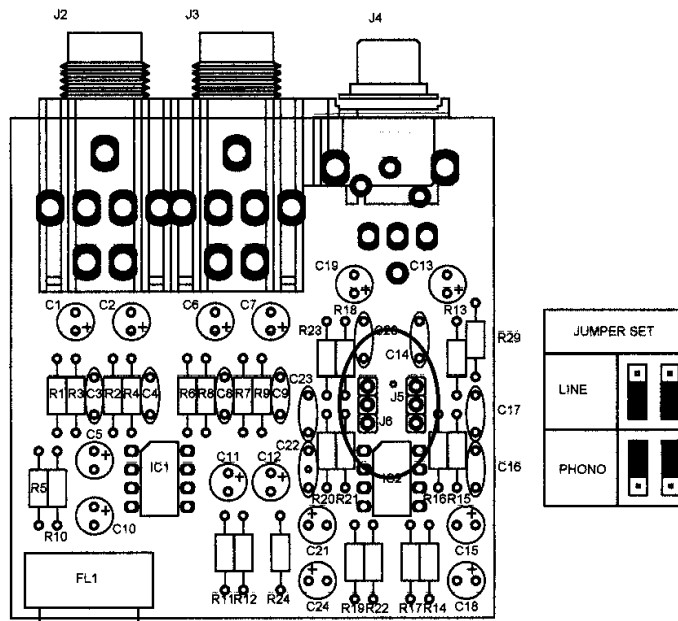

Jumper setting **LINE / PHONO** on the **INPUT B / Channel 4,5 & 6 Stereo input board (Oxygen 3 ST)**

## 6 TELEPHONE CONNECTIONS (OXYGEN 3 and 3 ST)

The Telephone module features a **built-in telephone hybrid**.

The audio sent to the telephone caller is a mix-minus (N-1). The mix minus signal is the programme output signal with the phone signal (caller's voice) removed.

Connections:

**LINE:** RJ11 socket for telephone line connection

NOTE: Oxygen 3 and 3 ST hybrids operate on **standard POTS** (Plain Old Telephone Service) / **PSTN** (Public Switched Telephone Network) analog telephone lines. Automatic line compensation is featured.

**TEL / PHONE** socket: allows the connection on parallel of a external telephone set (f.i. for dialling services). Please note that this socket is always active (i.e. it doesn't depend on the 'Hook' button).

The two RJ11 connectors will accept 4 conductor modular plugs, but only the 2 central conductors (typically Red & Green ) are used.

**R/L (OUT REC on PIN RCA):** double mono output which allows recording of the telephone calls (either SEND or RECEIVE signals).

**CALL** (terminal board connector): connector for external call signalling. A photocoupler inside the module closes when a telephone call comes (ring).

NOTE: Typical current allowed on the photocoupler: 5 mA (max 10 mA). Max voltage allowed: 15 V.



## 7 OUTPUT CONNECTIONS (OXYGEN 3 and 3 ST)

### 7.1 MASTER outputs

The Oxygen 3's Master section gives the operator an extensive set of resources.

In addition to two Master balanced outputs (**Out 1** and **Out 2**, carried on DB15 female connector), provision has been made for an unbalanced, level-controlled output on PinRca connector (**Out 3**), an unbalanced, fixed level on PinRca connector (**Fixed**) and two **Mono** outputs (summing the left and right channels and dropping the level by 6dB). All the Master outputs provide the same Master signal.

#### OUTPUT OVERVIEW

Out 1	Balanced stereo Output (with Level and Balance controls)	DB 15p female
Out 2	Balanced stereo Output (with Level and Balance controls)	DB15p female
Out 3	Unbalanced stereo Output (with Level and Balance controls)	PinRca
Fixed	Unbalanced stereo Output (with Balance control)	PinRca
Mono	Unbalanced mono Output	PinRca

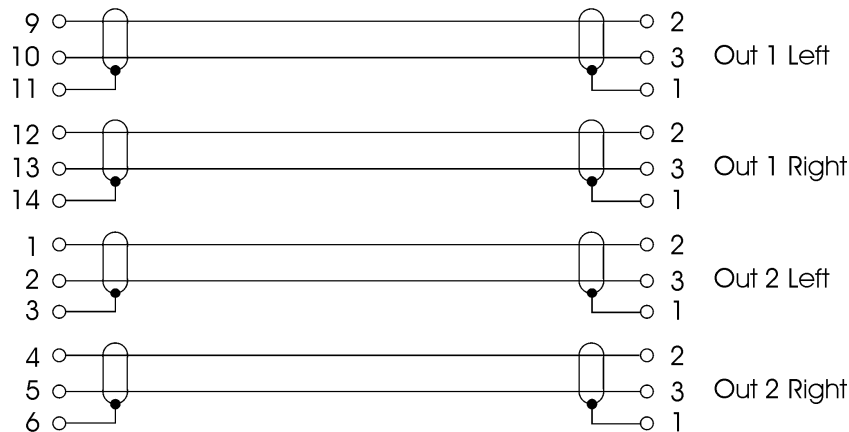
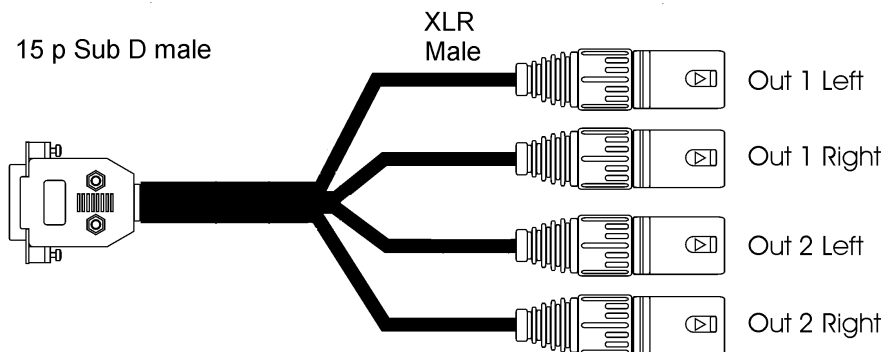

**7.2 MONITOR OUT and EXT-IN connections (OXYGEN 3 and 3 ST)**

The Oxygen 3's Monitor section gives the operator an extensive set of resources.

In addition to monitoring the Master and PFL audio buses, provision has been made for monitoring an external audio source. This stereo input (Ext-In) is intended to be connected to microwave, FM or satellite receivers or another studio.

MONITOR output is a stereo line-level output, provided for connection to a power amplifier associated with loudspeakers.

A selective 'muting' of *Monitor* speakers is also provided on series. When **microphone 1** is live to air, the monitor speakers in the room containing the microphone will be muted so that there is no acoustic feedback.

Oxygen 3 and Oxygen 3 ST come from the factory with *Muting* facility associated to Slider opening on Channel 1. On request, this facility may be extended to Input channels 2 and 3, too (by means of regular slider replacement – ref to par. 3 - Options)

The slider opening on Channel 1 is also associated to a photocoupler closing on **TB** (TALKBACK) SubD 9 pin connector. This photocoupler may be used to control an On Air Lamp (such as MR. LIGHT by Axel Technology).

**MONITOR MODULE – CONNECTIONS OVERVIEW**

MONITOR OUT	Unbalanced stereo	PIN RCA
EXT IN	Unbalanced stereo Input	PIN RCA
POWER	External AC adapter	SubD 9p male
TALKBACK	Unbalanced TALKBACK / MASTER Output (switched) + OnAir Light control	SubD 9p female

**TALKBACK Connector PinOut:**

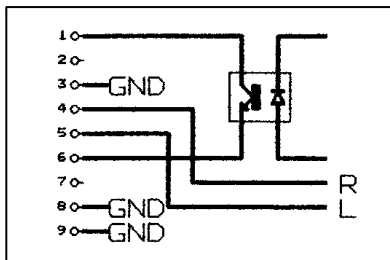

Pin 1	'On Air' photocoupler - Collector	
Pin 2	Not connected	
Pin 3	Ground GND	
Pin 4	TB / MASTER output Right	
Pin 5	TB / MASTER output Left	
Pin 6	'On Air' photocoupler - Emitter	
Pin 7	Not connected	
Pin 8	Ground GND	
Pin 9	Ground GND	

**7.3 LED-METERS**

SubD 15 P male connector for led-meters connection.

## 8 OXYGEN 3 – INPUT MODULE DESCRIPTION

### 8.1 CHANNELS 1 to 6

**A/B SWITCH:** The **B SEL** switch selects the INPUT B socket when depressed and the INPUT A when released. A LED glows **green** when the INPUT B is selected. Input A is set for Micro level on Channels 1 to 3, for Line level on the Channels 4 and 5 and for Phono level on the Channel 6 if not otherwise indicated.

**GAIN:** The GAIN potentiometer provides a variable 24dB range (from -12 to +12dB) gain to match the connected source to the internal 0 dBu operating level. This knob allows you to match the input level to suit a wide variety of professional and semiprofessional sources. Start with a low setting, especially for professional equipment, checking the level on the meters using **PFL**, and increase it if you cannot reach an average 0 dB level with the fader at maximum (refer also to section 10.1).

**EQUALISER:** The Equaliser comprises three sections. The upper control provides H.F.(treble) boost and cut of + 6 / -12 dB at 13 kHz, and the lower control provides L.F. (bass) boost and cut of + 6 / -12 dB at 60 Hz.

The centre knob is arranged as MID frequency section, with a cut/boost control (lower knob) of + 6 / - 12 dB for a frequency range from 80Hz to 10 kHz.

Set the cut/boost control of each section to the centre-detented position when not required.

**MASTER:** The input channel signal may be routed to the main Stereo MIX (MASTER L / R) by pressing the Master switch.

There is a green LED inside which will illuminate accordingly.

**PFL:** Stereo pre-fade listening PFL button (operated only in latched mode) allows pre-fade listening (post-EQ) of the channel with the fader closed. Even when the channel is active, the PFL system is active. It always operates in the ADDITIVE Mode (i.e. You can listen to one or more PFLs at the same time by pressing one or more PFL keys).

To listen to a PFL:

- 1) select the PFL key on the input channel to be monitored
- 2) release both the MASTER and EXT-IN buttons on the MONITOR section (ref. to section 11.3)

**SLIDER:** **ALPS N**-type 90° ultra smooth 100 mm sliders are provided on series.

The scale shows the attenuation. Normal operating position is at the top '0' mark, providing overall 0 dB of gain. **On request, to notify at order, ALPS K** series sliders can be also fitted. The benefit is longer fader life.

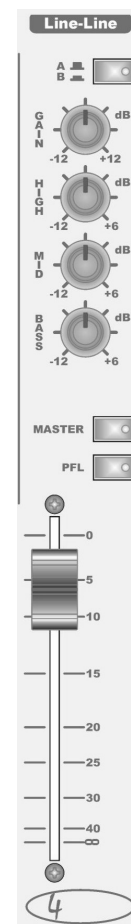

**CHANNEL 1** (labelled MicDJ / Line) may be regarded as a 'priority' channel: the POST-EQ (and pre-fader) signal is always internally routed to the TalkBack circuitry and to the Telephone channels for 'private' (off-air) communications with the callers. The Post Fader, channel Master output is also routed to the TalkOver section for automatic voice/music mix. We therefore suggest to use the First Channel as a 'micro' channel connected to the DJ / Announcer microphone.

## 9 OXYGEN 3 ST – INPUT MODULE DESCRIPTION

### 9.1 CHANNELS 1 to 6

**A/B SWITCH:** The **B SEL** switch selects the INPUT B socket when depressed and the INPUT A when released. A LED glows **green** when the INPUT B is selected. Input B is set for Micro level on Channels 1 to 3, for Line level on the Channels 4 and 5 and for Phono level on the Channel 6 if not otherwise indicated.

**GAIN:** The GAIN potentiometer provides a variable 24dB range (from -12 to +12dB) gain to match the connected source to the internal 0 dBu operating level. This knob allows you to match the input level to suit a wide variety of professional and semiprofessional sources. Start with a low setting, especially for professional equipment, checking the level on the meters using **PFL**, and increase it if you cannot reach an average 0 dB level with the fader at maximum (refer also to section 10.1).

**BALANCE:** It adjusts the stereo image of the signal on the stereo line input (i.e. the balance between the L and R outputs). At the detented centre position the signal routes equally to L and R.

**MASTER:** The input channel signal may be routed to the main Stereo MIX (MASTER L / R) by pressing the Master switch. There is a green LED inside which will illuminate accordingly.

**PFL:** Stereo pre-fade listening PFL button (operated only in latched mode) allows pre-fade listening (post-EQ) of the channel with the fader closed. Even when the channel is active, the PFL system is active. It always operates in the ADDITIVE Mode (i.e. You can listen to one or more PFLs at the same time by pressing one or more PFL keys).

To listen to a PFL:

- 1) select the PFL key on the input channel to be monitored
- 2) release both the MASTER and EXT-IN buttons on the MONITOR section (ref. to section 11.3)

**SLIDER:** **ALPS N-type** 90° ultra smooth 100 mm sliders are provided on series.

The scale shows the attenuation. Normal operating position is at the top '0' mark, providing overall 0 dB of gain. **On request, to notify at order, ALPS K series sliders can be also fitted. The benefit is longer fader life.**

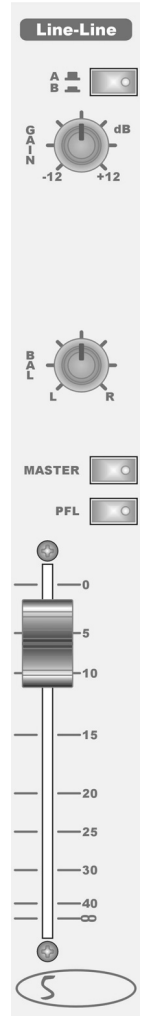

**CHANNEL 1** (labelled MicDJ / Line) may be regarded as a 'priority' channel: the POST-EQ (and pre-fader) signal is always internally routed to the TalkBack circuitry and to the Telephone channels for 'private' (off-air) communications with the callers. The Post-Fader, channel Master output is also routed to the TalkOver section for automatic voice/music mix. We therefore suggest to use the First Channel as a 'micro' channel connected to the DJ / Engineer microphone.

## 10 TELEPHONE CHANNELS (OXYGEN 3 and 3 ST)

The Telephone module features a **built-in telephone hybrid**.

The module features two gain controls, PFL, Master output, hybrid Hook / Ring controls. It features connections to a regular telephone line (POTS) and to an external standard telephone set (f.i. for dialling). Automatic line compensation is also featured.

The audio sent to the telephone caller is a mix-minus (N-1). The mix minus signal is the programme output signal with the phone signal (caller's voice) removed.

The presenter can talk *off-air* with a caller (whilst the Main programme is being output) via its own microphone (connected to **Channel 1** module).

**HOOK** button: it allows Line hooking. This switch hooks / hangs up the hybrid from the telephone line. Hook LED switches on accordingly. The same **LED** blinks when a call (ring) is coming in. Please note: LED glows only if phone line is connected.

**SEND**: It adjusts in the +/- 12 dB range the level of *mix-minus* signal which is sent to the telephone caller.

**RECEIVE**: It adjusts in the +/- 12 dB range the level of the signal incoming from telephone caller.

**MEETING**: it allows the RECEIVE signal to be heard also by the other telephone caller.

**MASTER**: it connects the telephone output to the Master output. The LED inside the button turns on accordingly.

**PFL** Pre-fade listening PFL button (operated only in latched mode) allows a caller to listen to the **announcer/DJ** microphone (connected to Channel 1) and to be heard without being in the broadcast (i.e. with the fader closed).

When the PFL button is activated (with MASTER button deactivated):

- the channel (Receive) signal will be connected to the PFL output (see also MONITOR Chapter).
- the **DJ MIC** (i.e. the Mic connected to Channel 1 with A/B selection button released) is automatically routed to the caller for "off-air" (i.e. 'Private') communications with the engineer or the announcer (regardless of MST and PFL keys on the Micro 1 channel)

When the MASTER button is activated (regardless of the PFL key):

- the Master bus is automatically sent to the caller
- the caller is broadcast while Telephone channel fader opened

Note: with MASTER button enabled on Telephone channels, the signal sent to the telephone line (adjustable through SEND control) will be the sum of the signals coming from each module routed to the Master bus except from the two Telephone ones. The **mutual phone-user listening** can only be enabled via the MEETING function (on both the Telephone modules).

**SLIDER ALPS N-type 90°** ultra smooth 100 mm sliders are provided on series.

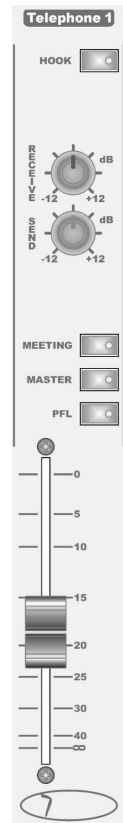

The scale shows the attenuation. Normal operating position is at the top '0' mark, providing overall 0 dB of gain. **On request, to notify at order, ALPS K series sliders** can be also fitted. The benefit is longer fader life and more reliable operation.

### **10.1 ALIGNEMENT OF INPUTS**

When plugging in a new source start with the fader turned down and the PFL activated. The signal is displayed on the meters on the left hand (PFL) and can be checked in the headphones or in the Monitor loudspeakers. Adjust the channel GAIN control for an average channel meter reading of '0' with loud moments lighting '+3'. Reduce the gain if the signal meter always ranges in the 0 to + 3dB area. It may be necessary to re-adjust the gain if changes are made to the equaliser.

## 11 OUTPUT MODULES DESCRIPTION (OXYGEN 3 and 3 ST)

### 11.1 MASTER section

**OUTPUT 1:** it controls the signal level on the output labelled OUTPUT 1 (balanced).

**OUTPUT 2:** it controls the signal level on the output labelled OUTPUT 2 (balanced).

**BALANCE:** it controls the signal balance on the outputs labelled OUTPUT 1-2-3 and FIXED.

**OUTPUT 3:** it controls the signal level on the output output labelled OUTPUT 3 (unbalanced).

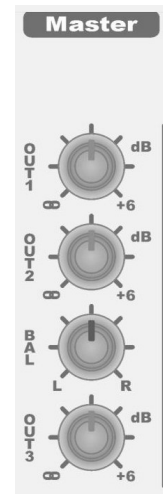

### 11.2 TALK OVER section

The TALK OVER section allows compression of all signals from CH 2 to 6 and of the TELEPHONE channels in favour of **CHANNEL1** (Master) output signal. It means that you can, f.i., automatically fade the level of music signals (from Stereo module) depending on the level of MIC1 microphone signal. This section will affect the MASTER outputs.

**DEPTH:** it controls the ratio of the compression: the lower is the value, the lower will be the compressed audio level. The TALK OVER function can be **disabled** by turning the DEPTH potentiometer in position **10**.

**THR(ESHOLD):** the trimmer inside the hole adjusts the threshold intervention level of the compressor (use a small screw-driver in order not to damage the trimmer).

**REL(EASE):** adjusts the release time of compressor: the higher is the value (turn it clockwise), the longer is the time needed to go back to the former audio level. (use a small screw-driver not to damage the trimmer).



### 11.3 MONITOR section

The Monitor section allows monitoring of selected buses (Ext In, Master, and PFL) without interfering with normal operation of the main (Master) audio bus. For operator assistance, the left pair of LED meters always visualize the level of the source selected in this section.

The **Monitor** section is capable of driving one pairs of headphones plus a *Line* output with separated level controls.

**POWER** button: it switches On / Off the console. The LED inside the button glows accordingly.

**EXT IN** control: it adjusts the EXT IN input signal level (for example a tuner signal)

**OUT** control: It affects the (line level) Monitor output on the rear panel.

**HEADPHONE** control: it affects the output to any headphones connected to the 1/4" jack phones socket

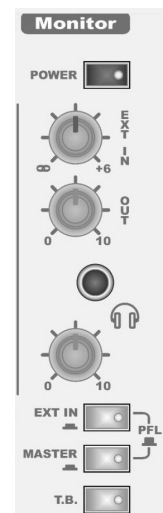

**Monitor Speaker Mute**

The Mute function (**Monitor speaker cut off**) always operates whenever Channel 1 (MicDJ / Line) is used (i.e. the fader is opened). This is to prevent acoustic feed-back (e.g. using a Studio microphone). MUTE function never affects headphone monitoring section.

**SOURCE SELECTION BUTTONS**

The core of the monitor section are the two monitor source buttons. The buttons allow one of the audio sources (as well as PFL signal) to be selected for monitoring as the Monitor speaker source.

EXT IN <b>pressed</b>	MASTER <b>depressed</b>	Monitor speakers / headphones will reproduce the EXTERNAL Input signal (f.i. a tuner)
--------------------------	----------------------------	---

EXT IN <b>depressed</b>	MASTER <b>pressed</b>	Monitor speakers / headphones will reproduce the MASTER signal
----------------------------	--------------------------	--

EXT IN <b>depressed</b>	MASTER <b>depressed</b>	Monitor speakers / headphones will reproduce the PFL signal
----------------------------	----------------------------	---

**TALK BACK BUTTON**

The **TALK BACK** button allows f.i. the Announcer (or the engineer) in the Control Room to transmit talkback to the Guest headphones when the button is pressed. TalkBack circuitry is always monodirectional.

The TalkBack output provides Master signal by default. Press and hold the *T.B. to Studio* button: it will connect the Channel 1 audio source to the TB output (ref to Rear Panel description – Section 7.2). The Channel 1 signal will always replace the existing Master signal.

NB The **CHANNEL 1** signal routed to TB circuitry is picked-up POST-EQ and PRE-FADER.



### 11.4 LED-METERS

The **Oxygen 3** and **Oxygen 3 ST** mixers are fitted with VU / PEAK LED meters.

VU meters respond to an average signal level, whereas PEAK LED glows when the 0dB threshold is over-passed (it remains 'on' long enough to provide easy recognition).

The VU meters are factory-calibrated and no further user adjustment is allowed.

A short cable with a 9 pins subD plug on each end (male and female) comes with the console. It is used to connect the meterbridge to the mixer.

The **RIGHT** pair of meters always display the Master signal.

The **LEFT** pair of meters show any combination of the **MASTER** output, the **EXTERNAL** input or **PFL** output is selected on the Monitor module.

For example, if Monitor section has **MASTER** selected, then the meters will display the **MASTER** signal. Of course, meters will also display the **PFL** signal, if **PFL** listening is selected (see par. 11.3)

### 12 BLOCK DIAGRAM (OXYGEN 3)

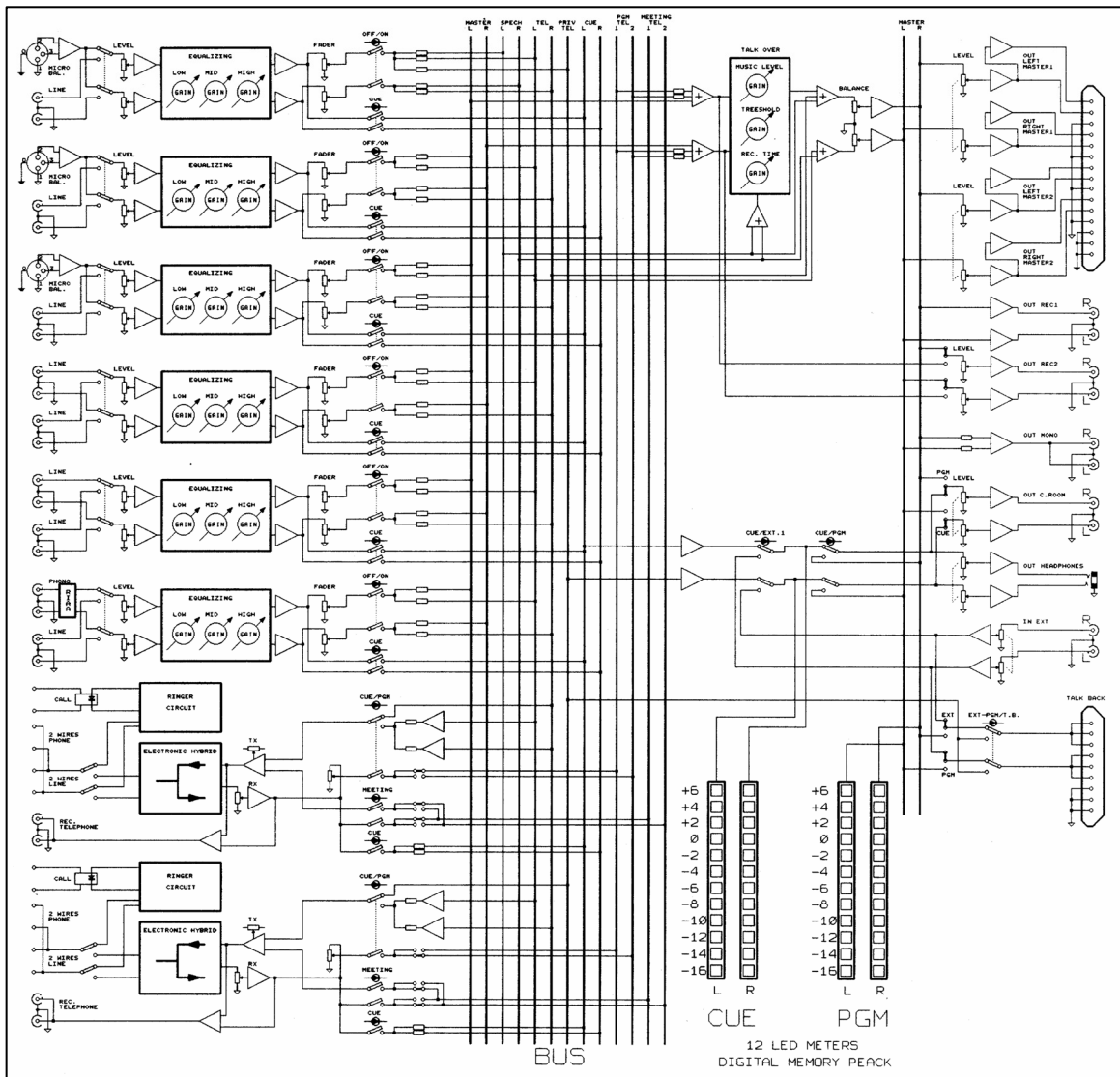

## 13 TECHNICAL SPECIFICATIONS

### 13.1 OXYGEN 3

#### LINE-LINE & LINE – PHONO STEREO MODULE

INPUT A	Stereo		PinRCA	
INPUT A levels	0 dBm (LINE – Channels 4 - 5)	Unbal		-12 to +12 dB gain control
	Phono (RIAA – Channel 6)	Unbal		-12 to +12 dB gain control
INPUT A impedance (line)	10 kOhm			
INPUT B	Stereo	Unbal	PinRCA	
INPUT B nominal level	0 dBm (LINE)			-12 to +12 dB gain control
INPUT B impedance	10 kOhm			

#### MONO/STEREO MODULE

INPUT A	Mono	EI. Bal.	XLR	
INPUT A nominal level	- 70 dB (MICRO level)			-12 to +12 dB gain control
INPUT A impedance	> 1,5 kOhm			
INPUT B	Stereo	Unbal	PinRCA	
INPUT B nominal level	0 dBm (LINE)			-12 to +12 dB gain control
INPUT B impedance	10 kOhm			

#### TELEPHONE MODULE

SEND / RECEIVE separ.	20 dB**	<i>** it can vary depending on telephone line characteristics</i>		
In / out level on tel. line	- 6 dBm on 600 Ohm line imped.			
Compensation mode	Electronic / automatic			
Line connection	2 wire, RJ11 connector			
REC outputs		Unbal	PinRCA	0 dB level

#### MASTER MODULE

MASTER Output 1 & 2	Stereo	EI. Bal.	SubD 15P	- inf to + 6 dB control
MASTER Output 3 and Fixed	Stereo	Unbal.	PinRCA	- inf to + 6 dB control (Out 3)
MASTER Mono Outputs	Mono	Unbal	PinRCA	0 dBm
Nominal MST Output Level	0 dBu (LINE)			
MST output Impedance	100 Ohm			

#### MONITOR MODULE

TUNER IN	Stereo Line	Unbal	PinRCA	- inf to + 6 dB gain control
MONITOR Output	Spk - Stereo Line	Unbal.	PinRCA	-inf to + 6 dBm
	Phones - Stereo Line	Unbal.	Jack 1/4"	-inf to +12 dBm
TALKBACK Output	Spk - Stereo Line	Unbal.	SubD 9p	

#### GENERAL

AC VOLTAGE	90 / 260V ( 50 – 60 Hz) - switching power supply
POWER CONSUMPTION	20 W
DIMENSIONS	178 mm (h) x 483 mm (w) x 340 mm (d).
WEIGHT	Around 5 Kg

## 13.2 OXYGEN 3 ST

### LINE-LINE & LINE – PHONO STEREO MODULE

INPUT A	Stereo	El Bal	Jack 1/4"	
INPUT A nominal level	0 dBm (LINE)			-12 to +12 dB gain control
INPUT A impedance	10 kOhm			
INPUT B	Stereo		PinRCA	
INPUT B levels	0 dBm (LINE – Channels 4 - 5)	Unbal		-12 to +12 dB gain control
	Phono (RIAA – Channel 6)	Unbal		-12 to +12 dB gain control
INPUT B line impedance	10 kOhm			

### MONO/STEREO MODULE

INPUT A	Stereo	El Bal	Jack 1/4"	
INPUT A nominal level	0 dBm (LINE)			-12 to +12 dB gain control
INPUT A impedance	10 kOhm			
INPUT B	Mono	El. Bal.	XLR	
INPUT B nominal level	- 70 dB (MICRO level)			-12 to +12 dB gain control
INPUT B impedance	> 1,5 kOhm			

### TELEPHONE MODULE

SEND / RECEIVE separ.	20 dB**	<i>** it can vary depending on telephone line characteristics</i>		
In / out level on tel. line	- 6 dBm on 600 Ohm line imped.			
Compensation mode	Electronic / automatic			
Line connection	2 wire, RJ11 connector			
REC Tel output		Unbal	PinRCA	0 dB level

### MASTER MODULE

MASTER Output 1 & 2	Stereo	El. Bal.	SubD 15P	- inf to + 6 dB control
MASTER Output 3 and Fixed	Stereo	Unbal.	PinRCA	- inf to + 6 dB control (Out 3)
MASTER Mono Outputs	Mono	Unbal	PinRCA	0 dBm
Nominal MST Output Level	0 dBu (LINE)			
MST output Impedance	100 Ohm			

### MONITOR MODULE

TUNER IN	Stereo Line	Unbal	PinRCA	- inf to + 6 dB gain control
MONITOR Output	Spk (Stereo Line)	Unbal.	PinRCA	-inf to + 6 dBm
	Phones	Unbal.	Jack 1/4"	-inf to +12 dBm
TALKBACK Output	Spk - Stereo Line	Unbal.	SubD 9p	

### GENERAL

AC VOLTAGE	90 / 260V ( 50 – 60 Hz) - switching power supply
POWER CONSUMPTION	20 W
DIMENSIONS	178 mm (h) x 483 mm (w) x 340 mm (d).
WEIGHT	Around 5 Kg

## 14 WARRANTY

The warranty covered by AXEL TECHNOLOGY S.R.L. has 1 year validity ex-work.

Do not open the equipment without being previously authorised by AXEL TECHNOLOGY, in case of seal breaking the warranty will expire.

AXEL TECHNOLOGY will not be responsible for any damage, of any origin, caused or related to an incorrect use of the product.