

Oxygen 4

Broadcast Mixing Console

Operating manual

(Rel. 1.6)



Via Caduti Di Sabbiano 6/F - 40011 Anzola Emilia - Bologna - Italy Tel. +39 051 736555 - Fax. +39 051 736170
e-mail: info@axeltechnology.com - web site: www.axeltechnology.com

1 TABLE OF CONTENTS

1	TABLE OF CONTENTS	3
2	FOREWORD	7
3	SAFETY WARNINGS	8
4	CONSIGNES DE SÉCURITÉ IMPORTANTES	10
5	ISTRUZIONI IMPORTANTI PER LA SICUREZZA	12
6	WICHTIGE SICHERHEITSHINWEISE	14
7	INSTRUCCIONES IMPORTANTES DE SEGURIDAD	16
8	UNPACKING AND INSPECTION	18
9	FIRST INSTALLATION RECOMMENDATIONS	19
9.1	POWER SUPPLY CABLE.....	19
9.2	AC MAINS VOLTAGE SETTING (230 V / 115 V).....	19
9.3	FUSE REPLACEMENT	20
9.4	PROTECTION AGAINST LIGHTNING	21
9.5	VENTILATION	21
9.6	EARTHING	22
9.7	POSITION.....	23
10	CONSOLE OVERVIEW	24
11	AVAILABLE OPTIONAL ACCESSORIES	25
12	BLOCK DIAGRAM	26
13	AUDIO CONNECTIONS	27
14	FACTORY PRESET CONSOLE CONFIGURATION	30
14.1	MODULE REMOVING AND INSTALLATION	32
14.2	ALIGNEMENT OF INPUTS	32
15	MONO MODULE	33
15.1	INTRODUCTION	33
15.2	MODULE OPTIONS AND JUMPER SETTINGS.....	34
15.3	INPUT REAR PANEL.....	35
15.4	A/B SWITCH	35
15.5	GAIN CONTROL.....	36
15.6	EQUALISER.....	36
15.7	PAN	36
15.8	MASTER-SUB ROUTING SWITCHES.....	37
15.9	PFL BUTTON	37
15.10	FADER.....	38
16	STEREO MODULE	39
16.1	INTRODUCTION	39
16.2	'START' OPTIONAL REMOTE INTERFACE.....	40
16.2.1	INTERFACE PIN-OUT	40

16.2.2	<i>INTERFACE DESCRIPTION</i>	40
16.3	'SSIR' OPTIONAL REMOTE INTERFACE.....	41
16.3.1	<i>'SSIR' INTERFACE PIN-OUT</i>	41
16.3.2	<i>INTERFACE CONFIGURATION</i>	42
16.3.3	<i>INTERFACE DESCRIPTION</i>	42
16.4	'LINE / PHONO INPUT B SETTING'.....	43
16.5	INPUT REAR PANEL.....	44
16.6	A/B SEL SWITCH.....	44
16.7	GAIN CONTROL.....	44
16.8	EQUALISER.....	45
16.9	BALANCE.....	45
16.10	MASTER-SUB ROUTING SWITCHES.....	45
16.11	PFL BUTTON.....	46
16.12	FADER.....	46
17	TELCO MODULE	47
17.1	INTRODUCTION.....	47
17.2	REMOTE INTERFACE CONNECTION.....	48
17.2.1	<i>REMOTE INTERFACE PIN-OUT</i>	48
17.2.2	<i>DESCRIPTION</i>	48
17.3	REAR PANEL CONNECTIONS.....	49
17.4	RECEIVE CONTROL.....	49
17.5	SEND CONTROL.....	50
17.6	HOOK SWITCH AND RING LED.....	50
17.7	PAN.....	50
17.8	MASTER-SUB ROUTING SWITCHES.....	51
17.9	PFL/PRIVATE BUTTON.....	51
17.10	FADER.....	52
18	TELEPHONE MODULE	53
18.1	INTRODUCTION.....	53
18.2	REAR PANEL.....	54
18.3	RECEIVE CONTROL.....	54
18.4	SEND CONTROL.....	54
18.5	HOOK SWITCH AND RING LED.....	55
18.6	PAN CONTROL.....	55
18.7	MASTER-SUB ROUTING SWITCHES.....	55
18.8	PFL/PRIVATE BUTTON.....	55
18.9	FADER.....	56
19	MASTER - SUB MODULE	57
19.1	INTRODUCTION.....	57
19.2	REAR PANEL.....	58
19.3	STEREO / MONO MODE SWITCHERS.....	58
19.4	REC 1 CONTROL SECTION.....	59
19.5	REC 2 CONTROL SECTION.....	59
19.6	MASTER ROUTING SWITCH.....	59
19.7	PFL BUTTON.....	59
19.8	SUB FADER.....	60
20	MONITOR MODULE	61
20.1	INTRODUCTION.....	61
20.2	MODULE OPTIONS AND JUMPER SETTINGS.....	62
20.3	REAR PANEL CONNECTIONS.....	63
20.4	TUNER LEVEL CONTROL.....	63
20.5	STUDIO MONITOR SECTION.....	64
20.6	CONTROL ROOM MONITOR SECTION.....	65

20.7	TB TO STUDIO BUTTON AND TB MICROPHONE	66
20.8	STUDIO AND CTRL ROOM PHONE PLUGS	67
21	POWER SUPPLY.....	68
21.1	FRONT VIEW	68
21.2	REAR VIEW	68
21.3	DESCRIPTION	68
21.4	PWS RELAYS.....	69
21.5	MIXER CONNECTION	69
21.6	MAIN AC VOLTAGE SETTINGS	70
21.7	PWS TROUBLESHOOTING	70
22	METERBRIDGE.....	72
22.1	VIEW	72
22.2	DESCRIPTION	72
22.3	METERBRIDGE SETTING	72
23	TECHNICAL SPECIFICATIONS.....	74
24	WARRANTY.....	75

SAFETY WARNINGS

CONSIGNES DE SÉCURITÉ IMPORTANTES

ISTRUZIONI IMPORTANTI PER LA SICUREZZA

WICHTIGE SICHERHEITSHINWEISE

INSTRUCCIONES IMPORTANTES DE SEGURIDAD

(Rel. 1.0)

2 FOREWORD

For your own safety and to avoid invalidation of the warranty all text marked with these Warning Symbols should be read carefully.



Information in this manual is subject to change without notice and does not represent a commitment on the part of the vendor.

The manufacturer shall not be liable for any loss or damage whatsoever arising from the use of information or any error contained in this manual, or through any mis-operation or fault in hardware contained in the product.

It is recommended that all maintenance and service on the product should be carried out by the manufacturer or its authorised agents. The manufacturer cannot accept any liability whatsoever for any loss or damage caused by service, maintenance or repair by unauthorised personnel.





3 SAFETY WARNINGS

The installation and servicing instructions in this manual are for use by qualified personnel only.

- **Read All Instructions.** All safety and operating instructions must be read before operating the product. They also must be retained for future reference, as it contains a number of useful hints for determining the best combination of equipment settings for Yr particular application.
- **Heed All Warnings.** All warnings on the product and those listed in the operating instructions must be adhered to.
- **Heat.** This product must be situated away from any heat sources such as radiators or other products (including power amplifiers or transmitters) that produce heat.
- **Power Sources.** This product must be operated from the type of power source indicated on the marking label and in the installation instructions. If you are not sure of the type of power supplied to your facility, consult your local power company. Make sure the AC main voltage corresponds to that indicated in the technical specifications. If a different voltage (ex. 110/115 VAC) is available, open the equipment closure and set the voltage switch on the main supply circuit, located behind the AC socket
- **Power Cord Protection.** Power supply cords must be routed so that they are not likely to be walked on nor pinched by items placed upon or against them. Pay particular attention to the cords at AC wall plugs and convenience receptacles, and at the point where the cord plugs into the product
- Clean only with dry cloth
-  Use only with a cart, stand, tripod, bracket, or table specified by the manufacturer, or sold with the apparatus. When a cart is used, use caution when moving the cart/apparatus combination to avoid injury from tip-over.
- **Lightning.** For added protection for this product during a lightning storm, or when it is left unattended and unused for long periods of time, unplug it from the AC wall outlet and the audio connections. This will prevent damage to the product due to lightning and power line surges
- **Installation.** Configuration and installation should only be carried out by a competent installation engineer
- **Cabling.** Using high quality wires, well protected. Make sure the cable integrity.
- **Equipment design.** This manual images could differ a bit from the equipment actual design

	This symbol alerts you to the presence of dangerous voltage inside the closure – voltage which may be sufficient to constitute a risk of shock. Do not perform any servicing other than that contained in the operating instructions. Refer all servicing to qualified personnel
---	---

	The exclamation point within an equilateral triangle is intended to alert the user to the presence of important operating and maintenance (servicing) instructions in the literature accompanying the appliance.
---	---

	<p>Do not change the voltage setting or replace the mains fuse without first turning the unit off and unplugging the mains cord.</p>
	<p>This apparatus must be EARTHED !</p>
	<p>To avoid risk of fire use the correct value fuse, as indicated on the label stuck on the right side of the unit.</p>
	<p>Make sure the AC main voltage corresponds to that indicated in the technical specifications.</p>
	<p>This apparatus uses a single pole mains switch and does therefore not separate the unit completely from the mains power. To completely separate from mains power (f.i. in the event of danger) unplug mains power cord. As the MAINS plug as the disconnect device, the disconnect device shall remain readily operable.</p>

4 CONSIGNES DE SÉCURITÉ IMPORTANTES





- Lire ces consignes
- Conserver ces consignes
- Observer tous les avertissements
- Suivre toutes les consignes
- Ne pas utiliser cet appareil à proximité de l'eau
- Nettoyer uniquement avec un chiffon sec
- Ne pas obstruer les ouvertures de ventilation. Installer en respectant les consignes du fabricant
- Ne pas installer à proximité d'une source de chaleur telle qu'un radiateur, une bouche de chaleur, un poêle ou d'autres appareils (dont les amplificateurs) produisant de la chaleur.
- Ne pas annuler la sécurité de la fiche de terre, la troisième branche est destinée à la sécurité. Si la fiche fournie ne s'adapte pas à la prise électrique, demander à un électricien de remplacer la prise hors normes.
- Protéger le cordon d'alimentation afin que personne ne marche dessus et que rien ne le pince, en particulier aux fiches, aux prises de courant et au point de sortie de l'appareil
- Utiliser uniquement les accessoires spécifiés par le fabricant
-  Utiliser uniquement avec un chariot, un support ou une table spécifié par le fabricant ou vendu avec l'appareil. Si un chariot est utilisé, déplacer l'ensemble chariot–appareil avec précaution afin de ne pas le renverser, ce qui pourrait entraîner des blessures
- Débrancher l'appareil pendant les orages ou quand il ne sera pas utilisé pendant longtemps.
- Confier toute réparation à du personnel qualifié. Des réparations sont nécessaires si l'appareil est endommagé d'une façon quelconque, par exemple: cordon ou prise d'alimentation endommagé, liquide renversé ou objet tombé à l'intérieur de l'appareil, exposition de l'appareil à la pluie ou à l'humidité, appareil qui ne marche pas normalement ou que l'on a fait tomber.
- **NE PAS exposer cet appareil aux égouttures et aux éclaboussures.** Ne pas poser des objets contenant de l'eau, comme des vases, sur l'appareil



Ce symbole indique la présence d'une tension dangereuse dans l'appareil constituant un risque de choc électrique.





Ce symbole indique que la documentation fournie avec l'appareil contient des instructions d'utilisation et d'entretien importantes.





	<p>Avant de modifier le commutateur de changement de tension ou remplacer le fusible il faut débrancher l'appareil de la prise électrique</p>
	<p>Pendant son usage, l'appareil doit être branché à la prise de terre</p>
	<p>Utiliser le fusible principal AC avec la valeur qui est indiquée sur l'étiquette collée sur le coffret.</p>
	<p>Assurez-vous que la tension principale AC correspond à celle indiquée dans les spécifications techniques.</p>
	<p>L'interrupteur d'alimentation interrompt un pôle du réseau d'alimentation excepté le conducteur de terre de protection. En cas de danger, débrancher le cordon d'alimentation. Parce que la prise du réseau de alimentation est utilisée comme dispositif de déconnexion, ce dispositif doit demeurer aisément accessible.</p>

5 ISTRUZIONI IMPORTANTI PER LA SICUREZZA

- Leggere le presenti istruzioni
 - Conservare queste istruzioni
 - Osservare tutte le avvertenze
 - Seguire scrupolosamente tutte le istruzioni
 - Non usare questo apparecchio in prossimità di acqua
 - Pulire l'apparecchio solo con un panno asciutto.
 - Non ostruire alcuna apertura per il raffreddamento. Installare l'apparecchio seguendo le istruzioni
- Non installare l'apparecchio accanto a fonti di calore** quali radiatori, aperture per l'afflusso di aria calda, forni o altri apparecchi (amplificatori inclusi) che generino calore
- **Non rimuovere il terminale di connessione a terra sul cordone di alimentazione:** esso ha lo scopo di tutelare l'incolumità dell'utilizzatore. Se la spina in dotazione non si adatta alla presa di corrente, rivolgersi ad un elettricista per far eseguire le modifiche necessarie.
 - **Evitare di calpestare il cavo di alimentazione o di comprimerlo**, specialmente in corrispondenza della spina e del punto di inserzione sull'apparato.
 - **Utilizzare solo dispositivi di collegamento e gli accessori specificati dal produttore.**
 -  Utilizzare l'apparecchio solo con un carrello, un sostegno, una staffa o un tavolo di tipo specificato dal produttore o venduto insieme all'apparecchio. Se si utilizza un carrello, fare attenzione negli spostamenti per evitare infortuni causati da ribaltamenti del carrello stesso
 - **Scollegare l'apparecchio dalla presa di corrente** durante i temporali o quando inutilizzato a lungo
 - **Per qualsiasi intervento**, rivolgersi a personale di assistenza qualificato. È necessario intervenire sull'apparecchio ogniqualvolta si verificano danneggiamenti di qualsiasi natura. Ad esempio, la spina o il cavo di alimentazione sono danneggiati, è entrato liquido nell'apparecchio o sono caduti oggetti su di esso, l'apparecchio è stato esposto alla pioggia o all'umidità, non funziona normalmente o è caduto.
 - **Non esporre a sgocciolamenti o spruzzi.** Non appoggiare sull'apparecchio oggetti pieni di liquidi, ad esempio vasi da fiori.

	Questo simbolo indica la presenza di alta tensione all'interno dell'apparecchio, che comporta rischi di scossa elettrica.
---	--

	Questo simbolo indica la presenza di istruzioni importanti per l'uso e la manutenzione nella documentazione in dotazione all'apparecchio.
---	--

	Non sostituire il fusibile o cambiare la tensione di alimentazione senza aver prima scollegato il cordone di alimentazione.
	L'apparato deve essere connesso a terra durante il suo utilizzo.
	Sostituire il fusibile generale con uno di identico valore, come indicato sulla etichetta applicata sul mobile dell'apparato.
	Assicurarsi che la tensione di rete corrisponda a quella per la quale è configurato l'apparecchio.
	Questo apparato utilizza un interruttore di alimentazione di tipo unipolare e l'isolamento dalla rete elettrica non è pertanto completo. Per ottenere un isolamento totale (ad esempio in caso di pericolo), scollegare il cordone di alimentazione. Inoltre, poichè la spina di alimentazione è utilizzata come dispositivo di sezionamento, essa deve restare facilmente raggiungibile.

6 WICHTIGE SICHERHEITSHINWEISE







- Diese Hinweise **LESEN**
- Diese Hinweise **AUFHEBEN**
- Alle Warnhinweise **BEACHTEN**
- Alle Anweisungen **BEFOLGEN**
- **Dieses Gerät NICHT in der Nähe von Wasser verwenden**
- **NUR mit einem sauberen Tuch REINIGEN**
- **KEINE Lüftungsöffnungen verdecken.** Gemäß den Anweisungen des Herstellers einbauen

Nicht in der Nähe von Wärmequellen, wie Heizkörpern, Raumheizungen, Herden oder anderen Geräten (einschließlich Verstärkern) installieren, die Wärme erzeugen

- **Die Schutzfunktion des Schukosteckers NICHT umgehen.** Bei Steckern für die USA gibt es polarisierte Stecker, bei denen ein Leiter breiter als der andere ist; US-Stecker mit Erdung verfügen über einen dritten Schutzleiter. Bei diesen Steckerausführungen dient der breitere Leiter bzw. der Schutzleiter Ihrer Sicherheit. Wenn der mitgelieferte Stecker nicht in die Steckdose passt, einen Elektriker mit dem Austauschen der veralteten Steckdose beauftragen
- **VERHINDERN, dass das Netzkabel gequetscht oder darauf getreten wird,** insbesondere im Bereich der Stecker, Netzsteckdosen und an der Austrittsstelle vom Gerät
- **NUR das vom Hersteller angegebene Zubehör** und entsprechende Zusatzgeräte verwenden.
-  **NUR in Verbindung mit einem vom Hersteller angegebenen oder mit dem Gerät verkauften Transportwagen, Stand, Stativ, Träger oder Tisch verwenden.** Wenn ein Transportwagen verwendet wird, beim Verschieben der Transportwagen-Geräte- Einheit vorsichtig vorgehen, um Verletzungen durch Umkippen
- **Das Netzkabel dieses Geräts** während Gewittern oder bei längeren Stillstandszeiten aus der Steckdose **ABZIEHEN.**
- **Alle Reparatur- und Wartungsarbeiten** von qualifiziertem Kundendienstpersonal **DURCHFÜHREN LASSEN.** Kundendienst ist erforderlich, wenn das Gerät auf irgendeine Weise beschädigt wurde, z.B. wenn das Netzkabel oder der Netzstecker beschädigt wurden, wenn Flüssigkeiten in das Gerät verschüttet wurden oder Fremdkörper hineinfelen, wenn das Gerät Regen oder Feuchtigkeit ausgesetzt war, nicht normal funktioniert oder fallen gelassen wurde.
- **Dieses Gerät vor Tropf- und Spritzwasser SCHÜTZEN.** KEINE mit Wasser gefüllten Gegenstände wie zum Beispiel Vasen auf das Gerät **STELLEN.**



Dieses Symbol zeigt an, dass gefährliche Spannungswerte, die ein Stromschlagrisiko darstellen, innerhalb dieses Geräts auftreten.







	<p><i>Dieses Symbol zeigt an, dass das diesem Gerät beiliegende Handbuch wichtige Betriebs- und Wartungsanweisungen enthält.</i></p>
	<p>Vor Änderung der Netzspannung oder Sicherungswchsel Netzkabel trennen.</p>
	<p>Das Gerät muss für den Betrieb geerdet werden.</p>
	<p>Hauptsicherung nur mit einer gleichwertigen austauschen (s. entsprechende Etikette).</p>
	<p>Vor Einschalten Netzspannungseinstellung am Gerät überprüfen bzw. anpassen.</p>
	<p>Inpoliger Netzschalter. In Notfälle oder für Wartungsarbeiten Netzkabel trennen. Der Netzstecker fungiert auch als Trennelement muss deshalb zugänglich bleiben</p>

7 INSTRUCCIONES IMPORTANTES DE SEGURIDAD

- **LEA** estas instrucciones
- **CONSERVE** estas instrucciones
- **PRESTE ATENCION** a todas las advertencias.
- **SIGA** todas las instrucciones
- **NO utilice** este aparato cerca del agua
- **LIMPIESE ÚNICAMENTE** con un trapo seco
- **NO obstruya ninguna de las aberturas de ventilación.** Instálese según lo indicado en las instrucciones del fabricante
- **No instale el aparato cerca de fuentes de calor** tales como radiadores, registros de calefacción, estufas u otros aparatos (incluyendo amplificadores) que produzcan calor
- **NO anule la función de seguridad del enchufe polarizado** o con clavija de puesta a tierra. Un enchufe polarizado tiene dos patas, una más ancha que la otra. Un enchufe con puesta a tierra tiene dos patas y una tercera clavija con puesta a tierra. La pata más ancha o la tercera clavija se proporciona para su seguridad. Si el toma corriente no es del tipo apropiado para el enchufe, consulte a un electricista para que sustituya el toma corriente de estilo anticuado
- **PROTEJA el cable eléctrico** para evitar que personas lo pisen o estrujen, particularmente en sus enchufes, en los toma corrientes y en el punto en el cual sale del aparato
- **UTILICE únicamente los accesorios especificados por el fabricante**
-  **UTILICESE únicamente** con un carro, pedestal, escuadra o mesa del tipo especificado por el fabricante o vendido con el aparato. Si se usa un carro, el mismo debe moverse con sumo cuidado para evitar que se vuelque con el aparato
- **DESENCHUFE el aparato** durante las tormentas eléctricas, o si no va a ser utilizado por un lapso prolongado.
- **TODA reparación** debe ser llevada a cabo por técnicos calificados. El aparato requiere reparación si ha sufrido cualquier tipo de daño, incluyendo los daños al cordón o enchufe eléctrico, si se derrama líquido sobre el aparato o si caen objetos en su interior, si ha sido expuesto a la lluvia o la humedad, si no funciona de modo normal, o si se ha caído.
- **NO exponga** este aparato a chorros o salpicaduras de líquidos. NO coloque objetos llenos con líquido, tales como floreros, sobre el aparato .



Este símbolo indica que la unidad contiene niveles de voltaje peligrosos que representan un riesgo de choques eléctricos.

	<p>Este símbolo indica que la literatura que acompaña a esta unidad contiene instrucciones importantes de funcionamiento y mantenimiento.</p>
	<p>Antes de cambiar la alimentación de voltaje o de cambiar el fusible, desconecte el cable de alimentación.</p>
	<p>Para reducir el riesgo de descargas eléctricas, esta unidad debe ser conectada a tierra.</p>
	<p>Replazze el fusible con lo mismo, que corresponde a lo indicado en el panel del equipo.</p>
	<p>Antes de encender, controlar que la línea de alimentación de voltaje corresponda a la indicada.</p>
	<p>El interruptor de alimentación es unipolar. En el caso de peligro, desconecte el cable de alimentación. Porque la clavija de conexión a red sirve por la desconexión de la unidad, la clavija debe ser ubicada en proximidad de la unidad.</p>

8 UNPACKING AND INSPECTION

Your equipment was packed carefully at the factory in a container designed to protect the unit during shipment. Nevertheless, we recommend making a careful inspection of the shipping carton and the contents for any signs of physical damage.

Damage & Claims

If damage is evident, do not discard the container or packing material. Contact your carrier immediately to file a claim for damages. Customarily, the carrier requires you, the consignee, to make all damage claims. It will be helpful to retain the shipping documents and the waybill number.

Save all packing materials! If You should ever have to ship the unit (e.g. for servicing), it is best to ship it in the original carton with its packing materials because both the carton and packing material have been carefully designed to protect the unit.

Under normal conditions no user maintenance or calibration are required. Internal links and preset controls may be set to configure the unit during installation. **Any service work required should be carried out by qualified service personnel only.**

We are able to offer further product support through our worldwide network of approved dealers and service agents.



To help us provide the most efficient service please would you keep a record of the unit serial number, and date and place of purchase to be quoted in any communication regarding this product.

The actual equipment Serial Number is indicated on the silver label stuck on the rear panel of the equipment closure.

Manufacturer		CE	
Model :	XXX	S-N :	KKKK
<input type="checkbox"/>	230V 50/60Hz	VA fuse	mAT
<input type="checkbox"/>	115V 50/60Hz	VA fuse	mAT

Tools And Equipment Needed

Only standard technician's tools are required to install this equipment.

9 FIRST INSTALLATION RECOMMENDATIONS

9.1 POWER SUPPLY CABLE

A power supply cable of approx. 2 m length is supplied with the device. The type of plug for the power supply depends on the country in which it is delivered. Supply cables should be laid in such a manner that one does not step or walk on them. They should not be squashed by any objects.

THIS EQUIPMENT MUST BE EARTHED.

The chassis is always connected to mains earth to ensure your safety: check your mains wiring and earthing before switching on.

9.2 AC MAINS VOLTAGE SETTING (230 V / 115 V)



BE SURE THAT THE UNIT IS SET TO THE CORRECT MAINS/LINE VOLTAGE FOR YOUR COUNTRY BEFORE PLUGGING IT INTO THE WALL OUTLET !

The actual Mains voltage is indicated on the label stuck on the equipment closure. Should the type of power at the operation location not be known, please contact your dealer or electricity company.

Manufacturer		CE	
Model :	XXX	S-N :	KKKK
<input type="checkbox"/>	230V 50/60Hz	VA fuse	mAT
<input type="checkbox"/>	115V 50/60Hz	VA fuse	mAT

If, for some reason, the unit is to be operated at a mains input voltage which is different to that as supplied, you need to open the top cover and set properly the **voltage change-over switch** which is located inside, close to the transformer. You also need to replace the AC main fuse, according to information provided on the Technical Specifications table at the end of this user manual.



CAUTION: TO REDUCE THE RISK OF ELECTRICAL SHOCK, ALWAYS DISCONNECT THE AC MAINS CABLE BEFORE ALTERING THE CHANGE-OVER SWITCH. NO USER SERVICEABLE PARTS INSIDE. REFER SERVICING TO QUALIFIED SERVICE PERSONNEL.

9.3 FUSE REPLACEMENT

The power supply socket has an integral fuse drawer containing the AC power fuse and a spare, both of the same value.



BEFORE REPLACING THE POWER FUSE, MAKE SURE YOU HAVE THE RIGHT TYPE OF FUSE FOR THE VOLTAGE TO BE PROTECTED.
USING WRONG FUSE TYPE WILL RESULT IN INSUFFICIENT PROTECTION.

Make sure that the power is switched off and the power cable is disconnected from the equipment.

Open the fuse drawer using a small blade screwdriver.

Replace the fuse located at the inner position

Push the fuse socket back into the original position

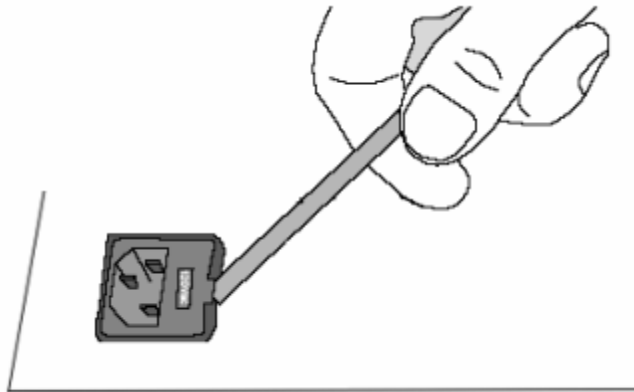

Perform the set-up under static control conditions. Static charges are likely to completely destroy one or more of the CMOS semiconductors employed in the unit. Static damage will not be covered under warranty.

Basic damage prevention consists of minimizing generation, discharging any accumulated static charge on your body and preventing that discharge from being sent to or through any electronic component.



Uninsulated dangerous voltage are inside the enclosure, voltage that may be sufficient to constitute a risk of shock.

Always disconnect to AC Mains before removing the top cover

9.4 PROTECTION AGAINST LIGHTNING



Should the device be put out of action due to being struck by lightning or excess voltage, disconnect it from the power supply without delay. Do not reconnect until the device has been checked. If in doubt contact the technical support service.

Make sure there is suitable lightning protection to protect the device. Alternatively you should disconnect all connectors from the device during a storm or when the device is going to be unsupervised or not used for a longer period of time. These measures will protect against damage by lightning or excess voltage.

9.5 VENTILATION

The equipment will operate as a free-standing unit without requiring any special cooling arrangement.

However, slots and openings in the product are provided for ventilation. They ensure reliable operation of the product, keeping it from overheating. These openings must not be blocked nor covered during operation.

IN THE EVENT OF RACK-MOUNTING THE UNIT, YOU MUST LEAVE AT A MINIMUM ONE RACK UNIT OF EMPTY SPACE ABOVE THE EQUIPMENT TO ENHANCE VENTILATION AND TO GET A LONGER EQUIPMENT LIFE.

9.6 EARTHING

The connection to earth (ground) in an audio system is crucial for two reasons:

1. SAFETY
2. AUDIO PERFORMANCE

For safety it is important that all equipment earths are connected to mains earth so that exposed metal parts are prevented from carrying high voltage which can injure the operator.

The same earth is also used to shield audio cables from external interference such as the hum fields associated with power transformers, lighting dimmer buzz, and computer radiation. Problems arise when the signal sees more than one path to mains earth. An earth loop results causing current to flow between the different earth paths. This condition is usually detected as a mains frequency audible hum or buzz. To ensure safe and trouble-free operation we recommend the following:

Use a clean mains outlet for the audio system: Be sure to use a 'clean' power outlet, i.e. one that is fed directly from the mains, including earth. "Polluted" mains are caused by changing currents on the outlets, such as air-conditioners, coffee machines, fridges, computers, dimmer packs etc. DO NOT connect any of these types of items to the Oxygen 4 main power outlet.

Use star point earthing: It is best to install a 'star point' system where the individual earths to the equipment racks and equipment areas are separately run from a solid central reference earth point. It is advisable to install several multiple mains connectors close to the Oxygen 4, with a master power switch to shut down all power to the studio..

Have your mains system checked by a qualified electrician.

Do not remove the earth connection from the console mains plug: The console chassis is connected to mains earth through the power cable to ensure your safety. Audio ground is connected to the console chassis internally.

If problems are encountered with earth loops disconnect the audio cable screens at one end, usually at the destination. Equipment such as CD players do not have a mains ground connection. In this case the shielding can be connected on both sides of the connection - a ground loop will not occur. Try to choose a CD player with metal housing.

Avoid induced interference: To prevent interference pickup keep audio cables away from mains power units, cables and distribution boards, motors, lighting and computer cables and equipment, and any other heavy duty electrical equipment. Where this cannot be avoided cross the audio and 'dirty' equipment cables at right angles to minimise interference.

Use low impedance sources such as microphones and line level equipment rated at 200 ohms or less to reduce susceptibility to interference. The console outputs are designed to operate at low impedance to minimise interference problems.

Use balanced connections where possible as these provide further immunity by cancelling out interference that may be picked up on long cable runs. To connect an unbalanced source to a console input (balanced), link the cold input (XLR pin 3 or jack ring) to 0V earth (XLR pin 1 or jack ground) at the console. To connect the console output (balanced) to an unbalanced destination, link the cold output to 0V earth at the console.

Use good quality cables and connectors and check for correct wiring and reliable solder joints. Allow sufficient cable loop to prevent damage through stretching.

If you are not sure ... Contact your Axel Technology agent for advice.

9.7 POSITION

The console should be located in a convenient space commensurate with the use to which the console is being put. Ideally a cool area is preferred not in close proximity to power distribution equipment or other potential sources of interference. Provision should be made for some flat surface surrounding the console to prevent people using it as a table top.

10 CONSOLE OVERVIEW

Oxygen 4 quality. The Oxygen 4 is a specially designed On-Air broadcast console. Although the design has been carefully budgeted, no compromises has been made in either quality or features, particularly in the areas of switching, signaling, fader start/stop and communication. Electronic components have been selected from the best on the market. Faders, potentiometers and switches are by ALPS. Most all of the switches have led indicators and all similar functions are grouped and colour coded, with additional fader knobs with different channel colour coding. Long throw faders give a smooth, repeatable response. VCA control for input module sliders is available as an option.

Oxygen 4 modularity The console is fully modular, which means flexibility in the configuration. The Mono, Stereo, Telco and Telephone input modules can be placed anywhere in the chassis. A partially loaded Oxygen 4 can be completed using low cost 'blind' modules. The modular approach to the design means that module replacement, or expansion of the system can be carried out quickly and efficiently. All modules are internally connected by a strong bus cable which clips into place - removal of the cable and two screws allows each module to be easily removed. Telephone module features a built-in, high quality telephone hybrid and Telco module can be interfaced to every external hybrid.

Self Contained. The Oxygen 4 is a complete and self contained piece of hardware, requiring no additional items in order to be operated. All relevant functions are built-in, such as fader start/stop (available as an option on the Stereo modules).

Oxygen 4 frames. Oxygen 4 console is available in three frame sizes: the frame 10, which can contain 10 overall modules, the frame 20 and the frame 30. A newer frame version is also available, which presents four traditional Vu Meters backlit housed in an elegant meterbridge.

The following photo-gallery shows all available models:



LED METER BRIDGE – 10 modules frame



LED METER BRIDGE – 20 modules frame



LED METER BRIDGE – 30 modules frame with script



VU METER BRIDGE – 20 modules frame

A script tray (10 module wide) is fitted for frame 30 version. The frames are inox steel + aluminium made, with wood finishing touch. Each console has always two output modules (Master/Sub and Monitor) to the far right which controls the Studio/Control Room monitoring, pre-fade listen and talkback functions together with the output selection (Stereo / Mono) of the Master and Sub signals. The meter bridge contains four VU / PPM meters (Monitor Left/Right + Master Left / Right).

Signaling and communications. Oxygen 4's wide range of functions provides the most immediate and complete broadcast control. For instance, it provides: Start/Stop commands, Studio - Control Room speakers cut-off, phantom microphone powering. All input/output connections are balanced on 1/4" jacks. The Oxygen 4 has also extensive possibilities for signaling and communications. The technician/producer/director can communicate with the announcer studio or to the callers connected to the Telco and Telephone modules for private communications. MONO modules allow also to control two relays activating ON-AIR lamps.

11 AVAILABLE OPTIONAL ACCESSORIES

OX4-MONO-EQ	Tone section (equalizer) for Mono module
OX4-ST-EQ	Tone section (equalizer) for Stereo module (L/L - P/L)
OX4-ST-START	Latched Start/Stop control from slider for Stereo module **
OX4-ST-SSIR	Momentary, relay-based Start/Stop control from slider for Stereo module **
OX4-ST-2SSIO	Momentary, opto Start/Stop control from slider for Stereo module - duplicated for Input A and B **
OX4-VCA	Slider K + VCA control for input module (Mono, Stereo, Telco...)
OX4-SCRIPT	Script Tray 10 units - 380 mm

****Start/Stop commands and VCA control options can not be fitted in the same Stereo module**

12 BLOCK DIAGRAM

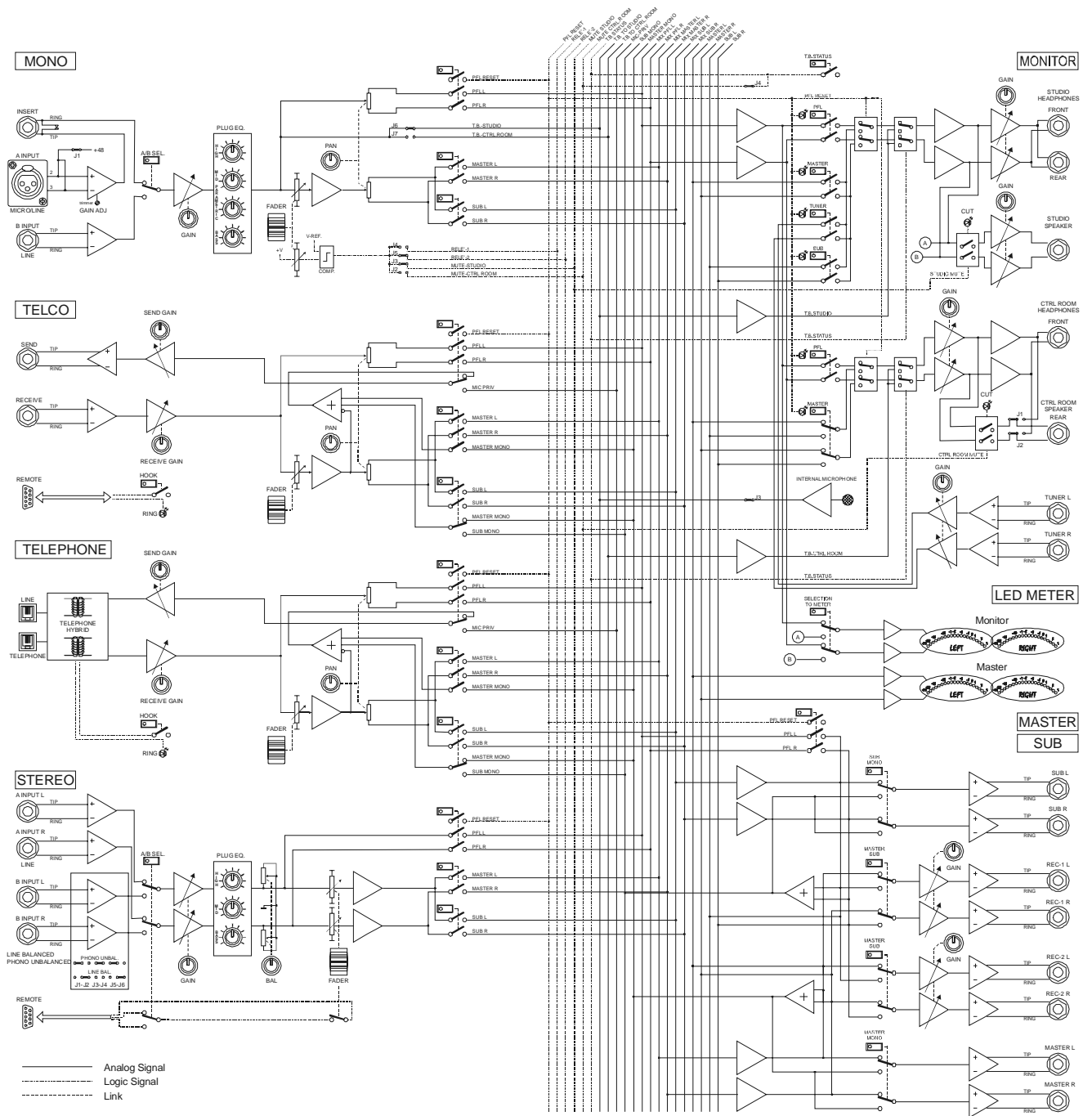

13 AUDIO CONNECTIONS

Matching the Console to Destination Equipment. The console produces a standard output level of 0dBu for a meter reading of '0'. It can produce a maximum of +20 dBm and is therefore well suited to driving equipment operating at nominal 0dBm or +4dBm while providing plenty of headroom.

XLR FEMALE SOCKET (Microphone input)

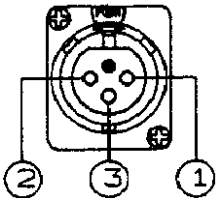

Pin	
1	Ground
2	In-phase (Hot)
3	Out-of-phase (Cold)
Short-circuit Pin 1 and 3 for unbalanced connections	

1/4" jack balanced conn. for MONO, STEREO (L&R), TELCO (Send&Receive), TUNER (L&R), MASTER (L&R), SUB (L&R), REC-1 (L&R), REC-2 (L&R) sockets

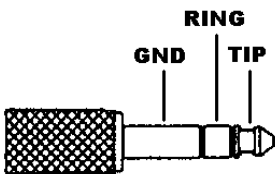

Pin	
Ground	Ground
Ring	Out-of-phase (Cold) (-)
Tip	In-phase (Hot) (+)

1/4" jack plug connectors for HEADPHONES and SPEAKERS sockets

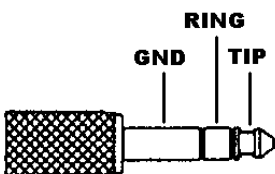

Pin	
Ground	Ground
Ring	Right Channel
Tip	Left Channel

1/4" jack plug connectors for 'INSERT' sockets (mono modules)

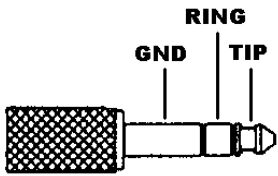

Pin	
Ground	Common Ground
Ring	Channel audio return (inserted from external equipment)
Tip	Channel audio output (to be provided to the external equipment)

EXAMPLE OF CONNECTIONS

BALANCED XLR

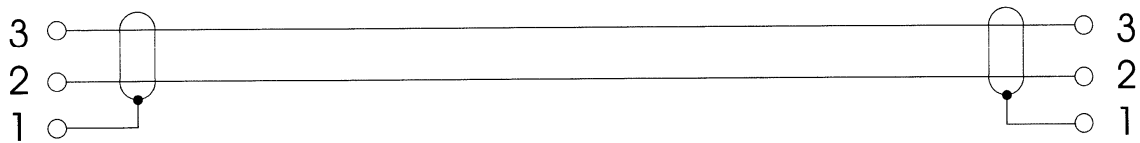

UNBALANCED (PHONO CONNECTIONS)

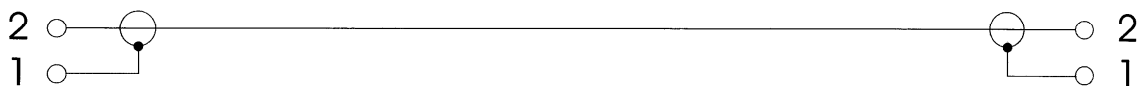

UNBALANCED XLR - JACK

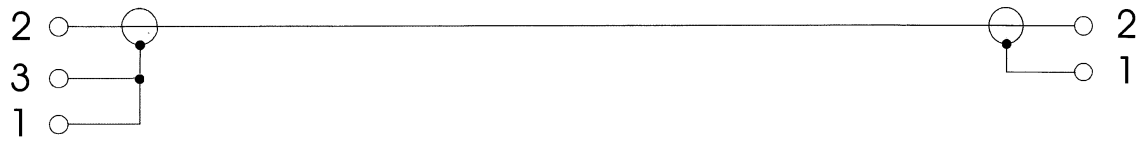

UNBALANCED XLR - PIN

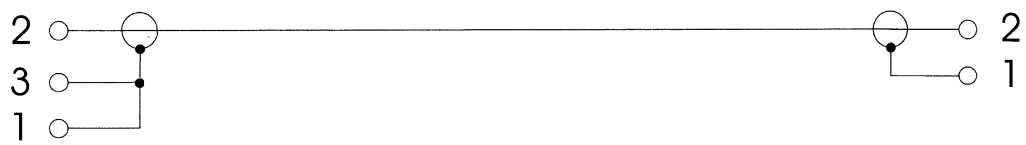

14 FACTORY PRESET CONSOLE CONFIGURATION

Oxygen 4 comes from the factory with the following settings:

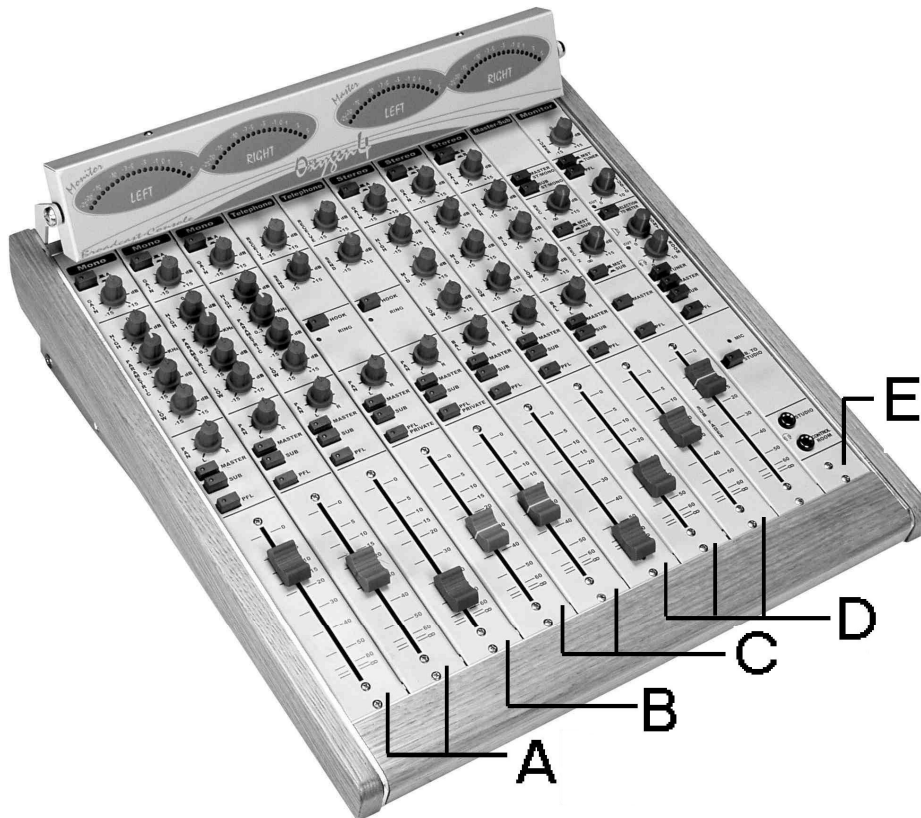

MONO MODULES (A and B) ref to par. 15.2

The Mono module closest to the centre of the console (**B**) is set for **Control Room** microphones and **Jumpers J2, J 4, J6** are **closed** (i.e. TalkBack path is routed to the Studio, Relay 1 in the PWS is addressed and Control Room Speakers are muted).

The Mono module(s) at Yr left hand (**A**) is (are) set for **Studio microphones** and **Jumpers J3, J 5, J7** are **closed** (i.e TalkBack path is routed to the Control Room, Relay 2 in the PWS is addressed and Studio Speakers are muted)

Phantom power is set as **disabled**

TELCO MODULES (C) ref to par. **Errore. L'origine riferimento non è stata trovata.**

No settings

STEREO MODULES (D) ref.to par. 16.3

If not otherwise notified, all the inputs are set for LINE-type sources

MONITOR MODULE (E) ref to par. 20.2 Studio Speaker output is set for LINE level, the TalkBack internal microphone is disabled, automatic Control Room speaker muting is set as disabled.

14.1 MODULE REMOVING AND INSTALLATION

Input modules can be removed and installed ONLY with the console powered off.

1) To remove a module from the mainframe:

- Unscrew the screw at the top of the module
- Unscrew the screw at the bottom of the module
- Unplug the module from the (internal) rear input board
- Unplug the module from the multipolar main flat cable (signal bus)

2) To remove a rear Input board from the mainframe

- Follow all the steps at the Point 1
- Unscrew the screw at the top of the rear plate
- Unscrew the screw at the bottom of the rear plate

14.2 ALIGNEMENT OF INPUTS

When plugging in a new source start with the channel muted or fader turned down and the PFL activated. This prevents any unexpected signal in the loudspeakers. The signal is displayed on the MONITOR meters.

Adjust the channel GAIN control for an average channel meter reading of '0' with loud moments lighting '+3'.

Adjust the Gain trimmers on Mono rear modules if the signal is still too high with the main Gain turned down. It may be necessary to re-adjust the gain if changes are made to the equaliser or inserted signal processing.

15 MONO MODULE

15.1 INTRODUCTION

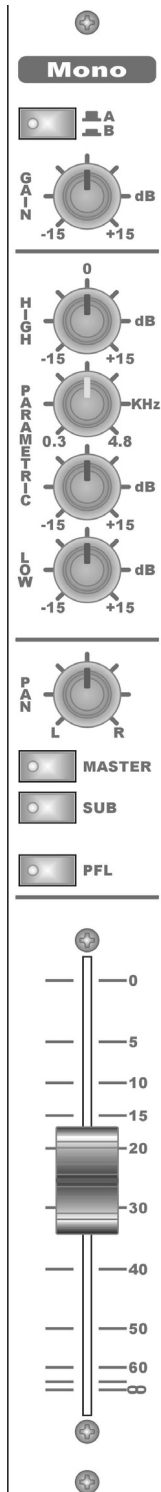

Each MONO module has two selectable mono inputs which comes factory preset for **Mic (input A)** and **Line (input B)** levels. Normally input A is selected but by pressing B SEL button the alternative input is selected.

There is a preset gain adjustments for A input with multi-turn control on the rear panel. The selected A or B source is fed through a common gain trim control giving a further +/- 15 dB of gain adjustment on the front panel. A jumper is also available inside the module to apply phantom power to microphone A input.

Mono modules can be fitted with an optional three band **parametric equaliser** (ref. MONO-EQ), where the centre band can be swept from 300 Hz to 4.8 kHz.

The signal is routed via a **Pan** control and the two stereo **routing switches** to either the main stereo programme (**Master**) or the stereo subgroup (**Sub**).

The PFL switch makes the pre-fade signal available for monitoring.

The Mono module is intended to be connected to Microphone either placed in the Control Room or in the Studio. Several jumpers allow the user to to route the TB accordingly to the microphone installation (TB will be set as 'TB to Control Room' when the announcer's microphone is in the studio and as 'TB to Studio' for use by the producer or the assistant in the Control Room).

A selective 'muting' of Control Room or Studio speakers is also provided via jumper settings. This option is for use with the mic input. When a microphone is live to air, the monitor speakers in the room containing the microphone will need to be muted so that there is no feedback.

So, for example, if the mic input is being used for a microphone in the studio, the studio monitors should be muted.

The module provides also a jumper selectable output to facilitate two relay closures for On-Air lamp switching on/off.

ALPS N-type 90° ultra smooth 100 mm sliders are provided on series. **On request, to notify at order, ALPS K/VCA series sliders** can be also fitted, the last ones controlling an internal high quality VCA circuitry.

15.2 MODULE OPTIONS AND JUMPER SETTINGS

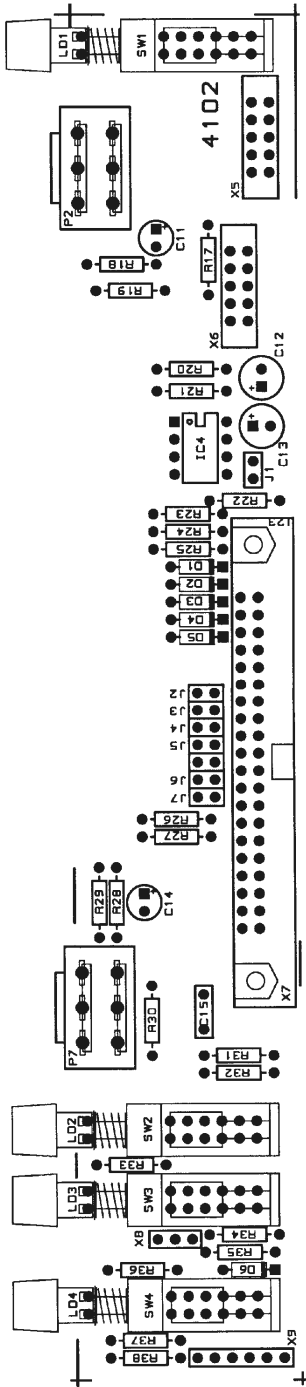

The MONO module can be configured in a number of different ways depending on the jumper options set. The jumpers are situated near to the **flat cable connector**:

When closed, the **A PHANTOM** jumper (**J 1**) allows for Phantom power on Input A. When using a phantom powered microphone, ensure that the mixer is switched off when the microphone is plugged in to the XLR connector.

When the **C.ROOM MUTE** jumper (**J 2**) is closed, the Fader opening is associated to the cut-off of the **C.ROOM SPK** output on the MONITOR module. CUT LED on the MONITOR Ctrl Room section illuminates accordingly.

When the **STUDIO MUTE** jumper is closed (**J 3**), the Fader opening is associated to the cut-off of the **STUDIO SPK** output on the MONITOR module. CUT LED on the MONITOR Studio section illuminates accordingly.

When the **RELAY 1** jumper (**J 4**) is closed, the Fader opening is associated to the switch of Relay #1 inside the Power Supply. This relay may be used to control an On Air Lamp (such as MR. LIGHT by Axel Technology).

When the **RELAY 2** jumper (**J 5**) is closed, the Fader opening is associated to the switch of Relay #2 inside the Power Supply. This relay may be used to control an On Air Lamp (such as MR. LIGHT by Axel Technology).

When closed, the **TB (to) STUDIO-SUB** jumper (**J 6**) put the signal from the pre-fade section of the module onto the TalkBack (to) Studio audio Bus and allows it to be output on the Studio Monitor section (see MONITOR module). The major use of this facility is also that TB STUDIO bus feeds the Telco and Telephone channels and will therefore allow the Producer to talk to a telephone caller off-air.

When closed, the **TB (to) CONTROL ROOM** jumper (**J 7**) put the signal from the pre-fade section of the module onto the TalkBack Ctrl Room audio Bus and allows it to be output on the Control Room Monitor section (see MONITOR module). The major use of this facility is the off-air communication from the Studio (e.g. the presenter) and the Control Room.

JUMPER SET	FUNCTION		
J1 	+ 48 PHANTOM POWER	X6 	BYPASS EQ. PLUG
J2 	C.ROOM MUTE	J3 	STUDIO MUTE
J4 	RELAY-1	J5 	RELAY-2
J6 	TB-STUDIO	J7 	TB-C.ROOM

15.3 INPUT REAR PANEL

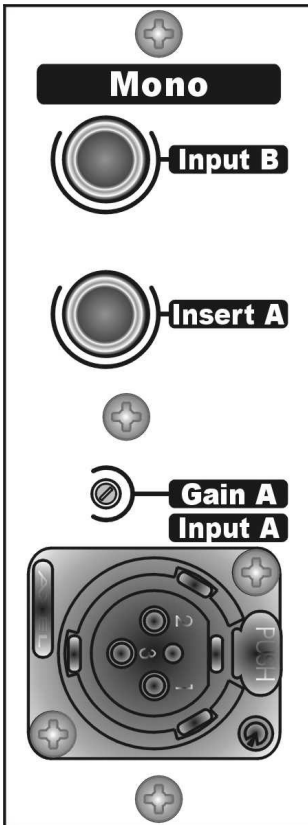

The **A Input** is via a standard female XLR-3 connector and it is set for **MICROPHONE** sources. The input is electronically balanced and it is factory-preset for around – 60 dB level.

The recessed **GAIN A trimmer** allows you to adjust in a very precise way the gain of the 'A' source. In conjunction with the GAIN potentiometer (see) this allows you to adjust the overall gain to any desired figure within the available range.

The **A PHANTOM jumper** on the PCB (see par. 15.2) applies phantom powering +48V to the MIC input A socket for condenser microphones.

WARNING: *The Phantom power is used to power microphones with built-in condenser or electret preamplifiers. This system requires both conductors to have the same D.C.potential. So, it's indispensable that cables and connectors are balanced and in perfect condition. If these rules are observed, Phantom power can be applied even dynamic microphones are connected, although it's preferable to avoid doing so.*

The **B Input** is via a standard female 1/4" Jack connector and it is set for signals providing a signal **LINE** level such as tape machines, RadioMic receivers, ISDN codecs. The input is electronically balanced and factory-preset for a 0 dB level.

Only one of the two inputs (Input A or Input B) will be active at any time, depending upon the setting of the **A/B switch** (see)

An unbalanced **INSERT** socket (**A**) is provided which is a break point in the input channel signal path. The insert point allows external piece of equipment such as limiters, compressors and other signal processing units to be added as required to particular input channels.

The Insert is a 3-pole 1/4" Jack Socket, which is normally by-passed. When a jack plug is inserted, the signal path is broken at a point just after the preamplifier stage, but before the Input Selection (A/B SEL key). The signal from the channel appears on the TIP of the plug and is returned on the RING to continue through to the final output.

15.4 A/B SWITCH



The **A/B** switch selects the INPUT B (Line) socket when depressed and the INPUT A (Mic) when released. A LED glows **red** when the INPUT B is selected.

Both left and right signal paths are fed by the same mono input signal.

15.5 GAIN CONTROL

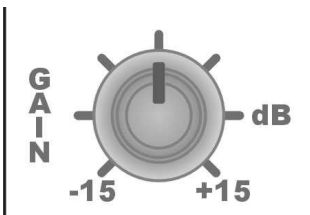

The **GAIN potentiometer** provides a variable 30dB range from - 15 to +15dB gain to match the connected source to the internal 0 dBu operating level

This knob allows you to match the input level to suit a wide variety of professional and semiprofessional sources. Start with a low setting, especially for professional equipment, checking the level on the meters using PFL, and increase it if you cannot reach an adequate signal level with the fader at maximum (refer also to par. 14.2).

15.6 EQUALISER

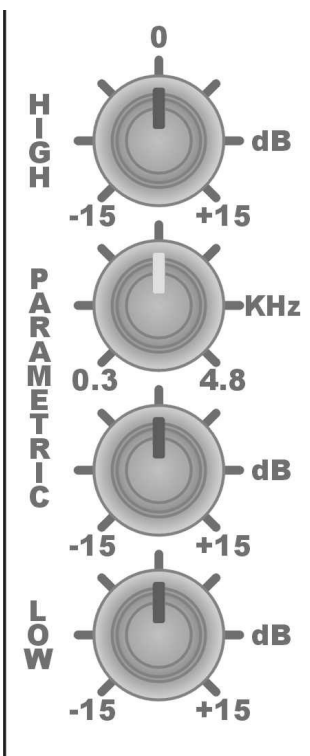

The Equaliser (**available as an option – MONO-EQ – Ref to Section 10**) comprises four sections. The upper control provides H.F.(treble) boost and cut of +/-15dB at 13 kHz, and the lower control provides L.F. (bass) boost and cut of +/-15dB at 60 Hz.

The centre two knobs is arranged as MID frequency section, with a cut/boost control (lower knob) of +/- 15dB, and a frequency control which determines at which frequency the boost/cut action will be centered. This MID section, with a combined frequency range from 300 Hz to 4.8 kHz is particularly versatile for speech, enabling particular characteristics of the presenter's voice to be lifted or suppressed very precisely.

Set the cut/boost control of each section to the centre-detented position when not required.

15.7 PAN

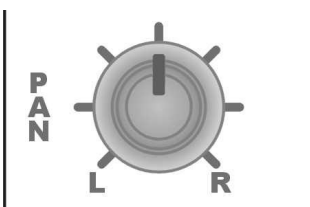

The PAN control determines the position of the signal within the stereo mix image. Rotation fully anticlockwise feeds the signal solely to the Left mix bus (Master & Sub outputs), while rotation clockwise sweeps the image to the Right mix bus (Master & Sub outputs).

The centre applies 0 dB of gain to both L & R signals.

15.8 MASTER-SUB ROUTING SWITCHES



The input channel signal may be routed to the main Stereo MIX (MASTER) and/or to the SUB bus by pressing the respective switches. There is a red LED inside each switch which will illuminate accordingly. The Sub mix can be mixed into the main mixbus (Master) (see MASTER switcher on the Sub module). This is a convenient way to use the SUB assignment as a subgroup system, creating new possibilities in the console.

15.9 PFL BUTTON



PFL button (operated only in latched) mode allows pre-fade listening (post pan-pot) of the channel even with the fader closed.

When the PFL button is activated, the channel signal will be connected to the PFL output and to the MONITOR meters circuitry (see also MONITOR Chapter).

The PFL system is always active and it operates in the ADDITIVE Mode (i.e. You can listen to one or more PFLs at the same time by selecting one or more PFL keys).

15.10 FADER

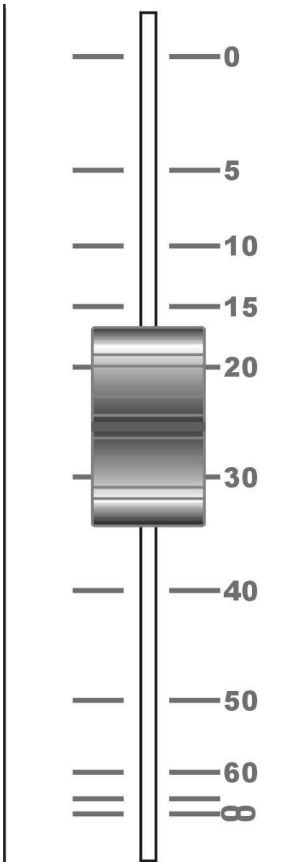

ALPS N-type 90° ultra smooth 100 mm sliders are provided on series.

The scale shows the attenuation. Normal operating position is at the top '0' mark, providing overall 0 dB of gain.

Fader opening always activates the channel.

On request, to notify at order, ALPS K/VCA series sliders can be also fitted, the last ones controlling an internal high quality VCA circuitry. There is no audio going through the VCA faders. VCA faders do not therefore suffer from such severe noise and signal loss problems that conventional faders may have when wear and tear causes the resistive surface to deteriorate. The benefit is longer fader life, as the crackles and dropouts typical of the traditional audio faders are smoothed out.

16 STEREO MODULE

16.1 INTRODUCTION

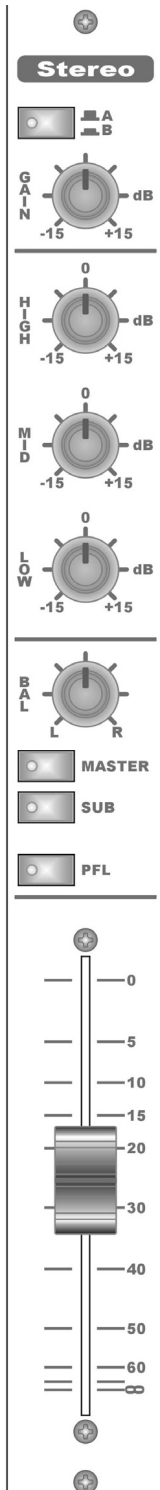

Each STEREO module has dual switchable stereo line inputs with optional three-band EQ. **Input A** comes factory preset for **Line**, while **input B** may be set for **Line** signals as well for **RIAA PHONE** signals via internal jumpers, so that a record-player can be connected directly to the input. Normally input A is selected but by pressing B SEL button the alternative input is selected.

The signal is routed via a Balance control and two stereo routing switches to either the main stereo programme (Master) or the stereo subgroup (Sub).

The PFL switch makes the pre-fade signal available for monitoring.

ALPS N-type 90° ultra smooth 100 mm sliders are provided on series. **On request, to notify at order, ALPS K/VCA** series sliders can be also fitted, the last ones controlling an internal high quality VCA circuitry.

Three Start/Stop interfaces are available as an option.

OX4-ST-START	latched Start/Stop on 'clean contacts' from slider
OX4-ST-SSIR	momentary Start/Stop relay closures from slider
OX4-ST-2SSIO	momentary, optoinsulated Start/Stop control from slider (duplicated for Input A and B)

NOTE: the here above listed Start/Stop options can not be added to slider VCA option.

16.2 'START' OPTIONAL REMOTE INTERFACE

Available on request, OX4-ST-START option adds latched Start/Stop control from slider on clean contacts.

With the slider at its 'bottom' position pins 2 and 3 (with A input selected) are opened, while with the slider arised the pins are closed. Two different pin closures are provided, depending on which input (A or B) is selected.

A 15 Vdc current-limited voltage is also provided for use with the remote control outputs.

16.2.1 INTERFACE PIN-OUT

SUB D 9P FEMALE

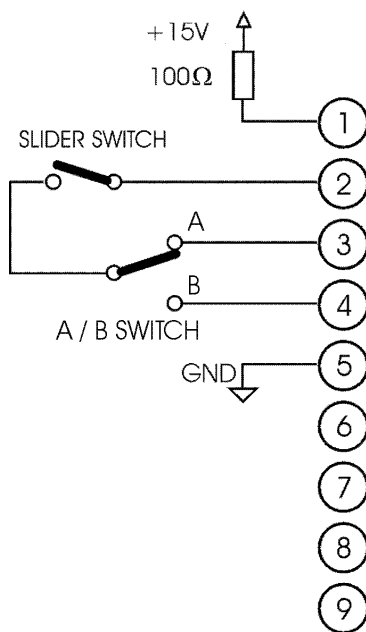

PIN	DESCRIPTION	DIRECTION
1	+ 15 V DC	OUT
2	Common Start / Stop connection	OUT
3	Start / Stop command while A input	OUT
4	Start / Stop command while B input	OUT
5	Ground GND	/
6	Not Connected	/
7	Not Connected	/
8	Not Connected	/
9	Not Connected	/

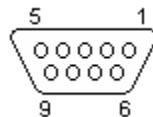

16.2.2 INTERFACE DESCRIPTION

Moving the slider away from the down position (-infinite), a short-circuit will appear between Pins 2 and 3 or between Pins 2 and 4, depending upon the selected Input source (A or B). Only one of the two Start commands (A or B) will be therefore active at any time, depending upon the setting of the **B SEL** switch (see).

The short-circuit will last as long as the slider is 'open' (thus always providing a 'latched' command).

A + 15 VDC is supplied on Pin 1 via a **100 Ohm resistor**.

Please, consider than max current allowed on Start/Stop circuit is 100 mA.

16.3 'SSIR' OPTIONAL REMOTE INTERFACE

Available on request, OX4-ST-SSIR option adds momentary, relay-based Start/Stop control from slider for Stereo module.

The outputs are **insulated relay contact closures** (one Relay for STOP and one for START).

A 15 Vdc current-limited voltage is also provided for use with the remote control outputs.

16.3.1 'SSIR' INTERFACE PIN-OUT

SUB D 9P FEMALE

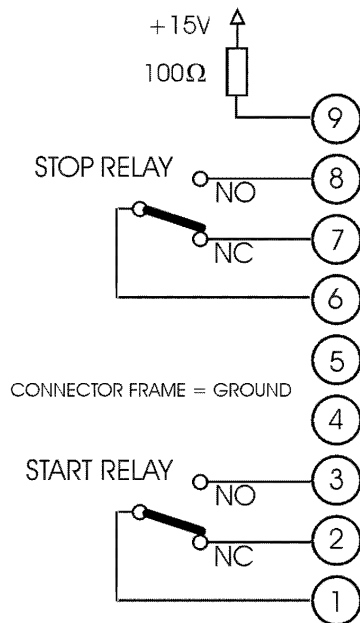

PIN	DESCRIPTION	DIRECTION
1	Common – Start Relay	OUT
2	NC – Start Relay	OUT
3	NO – Start Relay	OUT
4	Not Connected	/
5	Not Connected	/
6	Common – Stop Relay	OUT
7	NC – Stop Relay	OUT
8	NO – Stop Relay	OUT
9	+ 15 V DC	OUT
frame	Ground GND	/

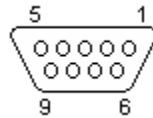

16.3.2 INTERFACE CONFIGURATION

The Start and Stop relays can be associated to the Input A or to the Input B. By default, they are associated to the Input A. The **Jumper J1**, placed on the interface PCB (close to the rear panel), allows for alter the assignment, as shown in the following picture:

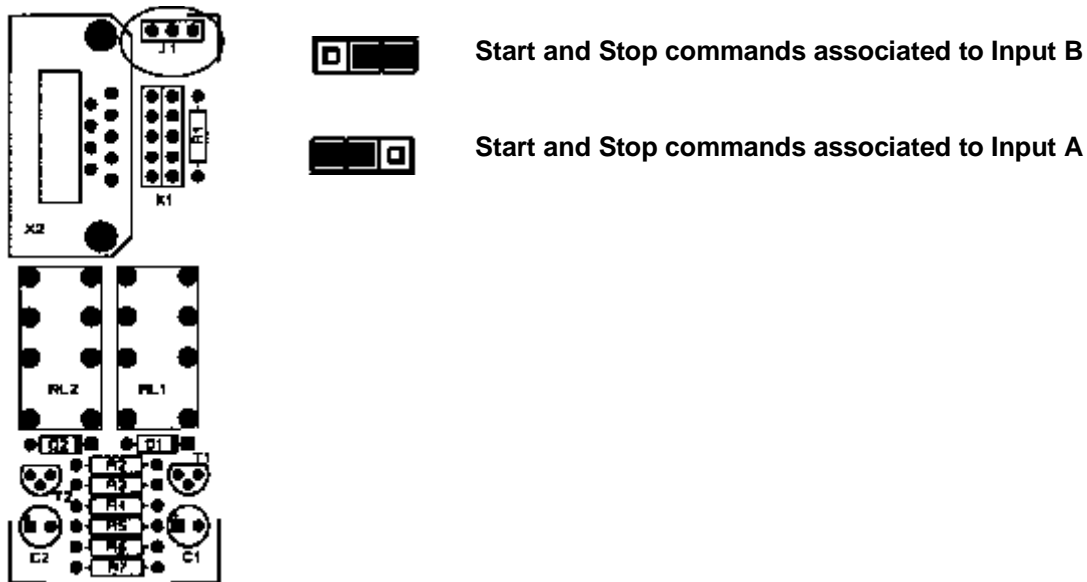

16.3.3 INTERFACE DESCRIPTION

By moving the slider away from its down position (- inf), a **momentary** start (clean contact) will be issued between Pins 1 and 3 (see START Relay)

The slider closure always issues STOP pulse via the STOP relay (Pins 6 and 8).

See previous section for command assignment to Input A or Input B.

A + 15 VDC is supplied on Pin 1 via a **100 Ohm resistor**.

Please, consider that max current allowed on Start/Stop relays is 500 mA at 24 Vdc.





16.4 'LINE / PHONO INPUT B SETTING

The **B Stereo Input** can be configured either for Line or Phono sources, depending on the jumper options set on the **input (rear) board**.

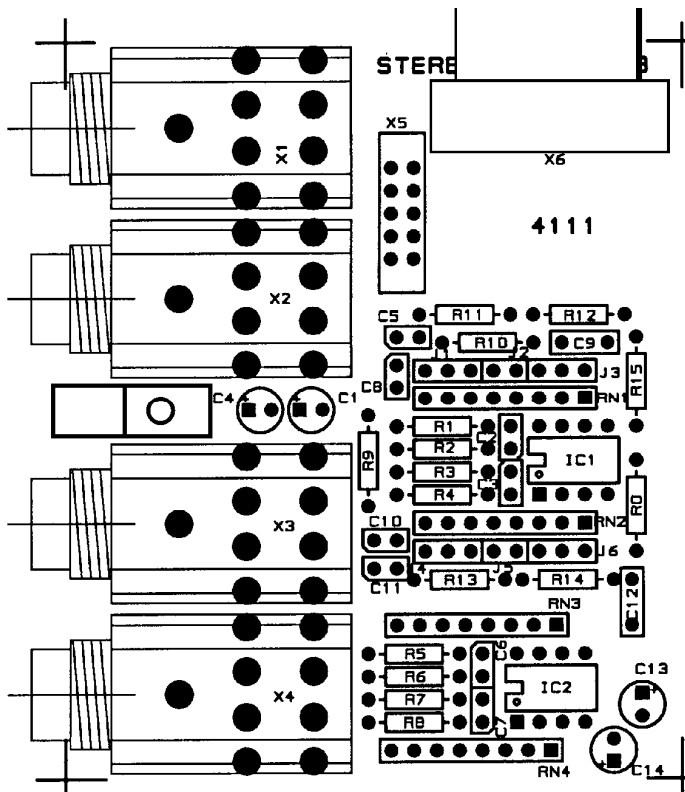
Phono configuration is suitable for **record-players**, as a **RIAA equalization is featured**. NOTE connection is possible only in unbalanced mode.

Line configuration is suitable for 0 dB level signals (f.i., coming from **tape player, tuners, Cd players**, etc).



JUMPER SET	FUNCTION
J1-J2-J3 	BALANCED LINE
J4-J5-J6 	
J1-J2-J3 	R.I.A.A.
J4-J5-J6 	

16.5 INPUT REAR PANEL

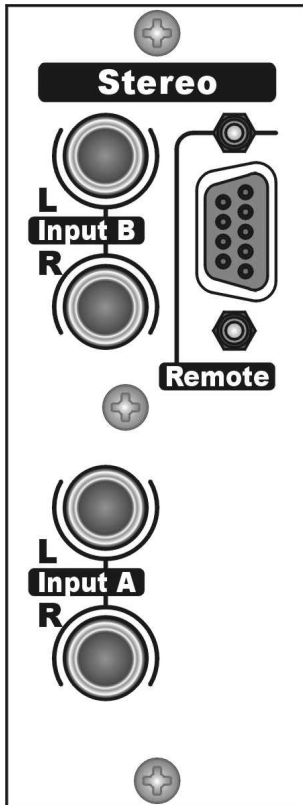

The **A Stereo Input** is via standard female 1/4" Jack connectors. It is electronically balanced and it is factory-preset for a 0 dB level (**LINE** sources).

The **B Stereo Input** is via standard Jack 1/4" connectors. It is set for signals providing a signal **LINE** level if not otherwise notified. Via jumper selection (ref to Section 16.4), an **RIAA equalized amplifier** can be also fitted so that a record-player can be connected directly to the input. **Start/Stop control** can be also provided via the 9 pins remote interface (available on request).

When set for LINE signals, the input B is electronically balanced.

When the *RIAA* option is used with the stereo channel, the turntable connections should be made via **Mono (unbalanced)** Jacks – as in the Connections chapter.

Only one of the two inputs (Input A or Input B) will be active at any time, depending upon the setting of the **B SEL** switch (see)

16.6 A/B SEL SWITCH



The **B SEL** switch selects the INPUT B (Line) socket when depressed and the INPUT A (Mic) when released. A LED glows **red** when the INPUT B is selected.

16.7 GAIN CONTROL

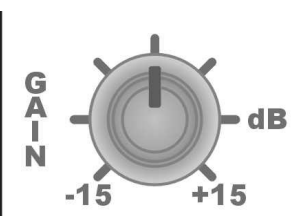

The **GAIN potentiometer** provides a variable 30dB range from +15 to +15dB gain to match the connected source to the internal 0 dBu operating level

This knob allows you to match the input level to suit a wide variety of professional and semiprofessional sources. Start with a low setting, especially for professional equipment, checking the level on the meters using PFL, and increase it if you cannot reach an adequate signal level with the fader at maximum (refer also to par. 14.2).

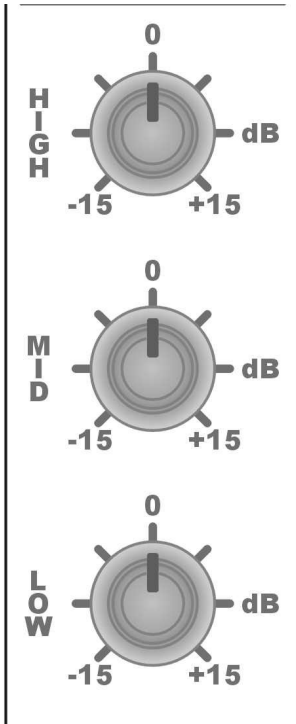
16.8 EQUALISER

The Equaliser (**available as an option – Ref to Section 10**) comprises three sections. The upper control provides H.F.(treble) boost and cut of +/- 15dB at 13 kHz, and the lower control provides L.F. (bass) boost and cut of +/-15dB at 60 Hz.

The centre knob is arranged as MID frequency section, with a cut/boost control of +/- 15dB for frequencies at around 5 KHz.

Set the cut/boost control of each section to the centre-detented position when not required.

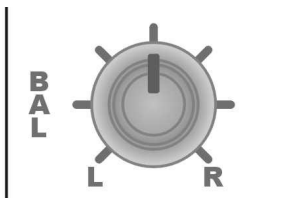
16.9 BALANCE

It adjusts the stereo image of the signal on the stereo line input (i.e. the balance between the L and R outputs). At the detented centre position the signal routes equally to L and R.

16.10 MASTER-SUB ROUTING SWITCHES

The input channel signal may be routed to the main Stereo MIX (L-R) and/or to the SUB bus by pressing the respective switches.

There is a red LED inside each switch which will illuminate accordingly.

The Sub mix can be mixed into the main output mixbus (Master) (see MASTER routing switcher on the Sub module). This is a convenient way to use the SUB assignment switch as a subgroup system, creating new possibilities in the Oxygen 4 console.

16.11 PFL BUTTON



PFL button (operated only in latched) mode allows pre-fade listening (post BAL-pot) of the channel even with the fader closed.

When the PFL button is activated, the channel signal will be connected to the PFL output and to the MONITOR meters circuitry (see also MONITOR Chapter).

The PFL system is always active and it operates in the ADDITIVE Mode (i.e. You can listen to one or more PFLs at the same time by selecting one or more PFL keys).

16.12 FADER

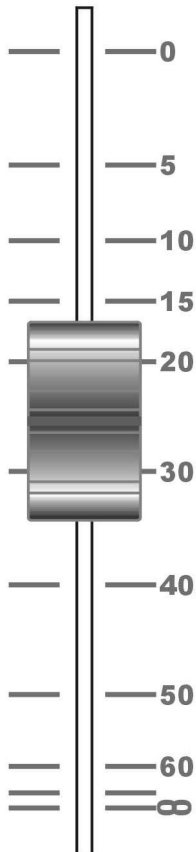

ALPS N-type 90° ultra smooth 100 mm sliders are provided on series.

The scale shows the attenuation. Normal operating position is at the top '0' mark, providing overall 0 dB of gain.

Fader opening always activates the channel.

On request, to notify at order, ALPS K/VCA series sliders can be also fitted, the last ones controlling the internal high quality VCA circuitry. There is no audio going through the VCA faders. VCA faders do not therefore suffer from such severe noise and signal loss problems that conventional faders may have when wear and tear causes the resistive surface to deteriorate. The benefit is longer fader life, as the crackles and dropouts typical of the traditional audio faders are smoothed out.

17 TELCO MODULE

17.1 INTRODUCTION

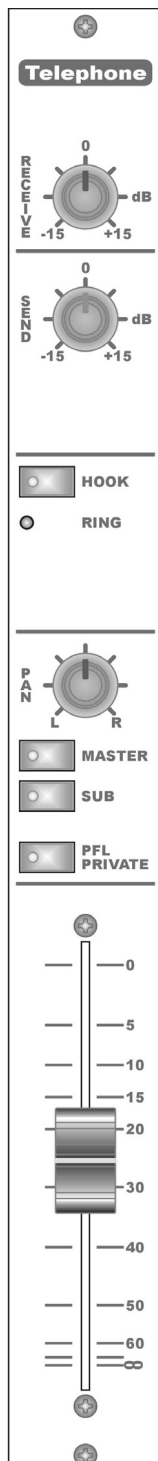

The telco module interfaces an external telephone hybrid with the console. A separate hybrid for each Telco module will be required.

It features two gain controls, PFL, Master and Sub output select, hybrid remote controls. It has only one mono input (**Receive**), the other Jack connector being used for the mix minus output (**Send**) to the telephone hybrid. The mix minus signal is the programme output signal with the phone signal (caller's voice) removed.

The engineer (or the presenter) can talk *off-air* with a caller (whilst the Main programme is being output) via its own microphone (connected to Mono module and routed as *TB to Studio*) or the *TB* microphone built-in into the Monitor module..

The 'Hook' button becomes the Line Hook Remote Divert control for suitable hybrids via the remote connector.

A '**RING**' LED (next to the Hook button) is provided for signalling of incoming calls.

ALPS N-type 90° ultra smooth 100 mm sliders are provided on series. **On request, to notify at order, ALPS K/VCA series sliders** can be also fitted, the last ones controlling an internal high quality VCA circuitry.

17.2 REMOTE INTERFACE CONNECTION

The 9 pin D-Type plug remote connector provides the inputs and outputs for the following functions:

- Remote control for line 'hooking' on the external telephone hybrid
- External control for RING LED (i.e. RING LED on the Telco module can be driven by a suitable external command)

A 15 VDC current-limited output is also provided for use with the remote control outputs.

17.2.1 REMOTE INTERFACE PIN-OUT

SUB D 9P FEMALE

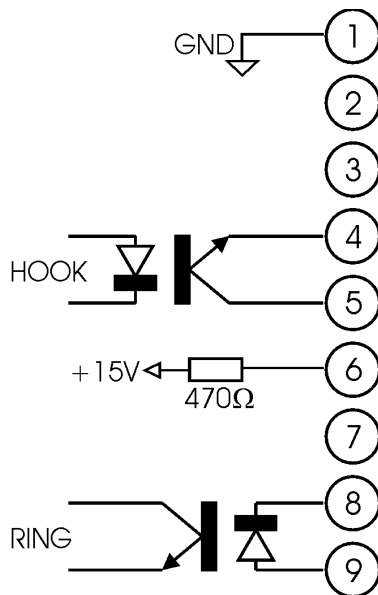

(console internal view)

PIN	DESCRIPTION	DIRECTION
1	Ground GND	/
2	Not Connected	/
3	Not Connected	/
4	HOOK command - emitter of photocoupler	OUT
5	HOOK command - collector of photocoupler	OUT
6	+ 15 VDC	OUT
7	Not Connected	/
8	External RING control - cathode of photocoupler	IN
9	External RING control - anode of photocoupler	IN

17.2.2 DESCRIPTION

Pins 8 and 9 are used to make RING LED on the Telco module panel blinking when a call is coming in.

The remote interface photocoupler (pin 9 = Anode and pin 8 = Cathode) must be driven by an external suitable command generated by external telephone hybrid. Typical current allowed: 5 mA (max 10 mA). Max voltage allowed: 15 V.

A + 15 VDC is provided on Pin 6 via a **470 Ohm resistor**.

The Oxygen 4's *Hook* optoinsulator closes whenever 'Hook' button is pressed. Typical current allowed: max 10 mA. Max voltage allowed: 15 V.

It may be necessary to consult the hybrid manufacturer's user manual in order to control its functions.

OXYGEN 4 Telco remote interface has been designed for **direct connection** to **BOXTEL** and **MACROTEL 5 / 7 / 9** by **Axel Technology**.

In particular, a regular, not crossed **Pin – to – Pin 9 pole cable** featuring **standard RS232** connectors (i.e 9 pin serial connection computer type) is required for **BOXTEL** connection.

17.3 REAR PANEL CONNECTIONS

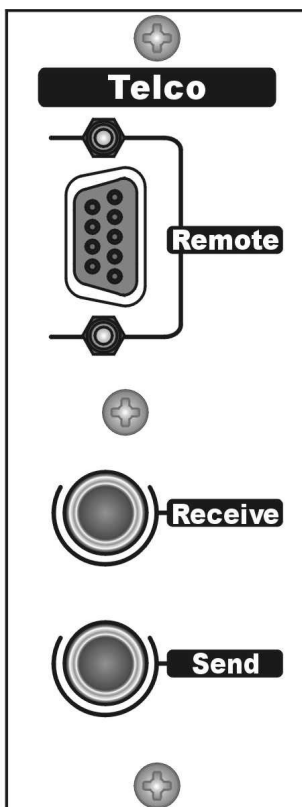

The REMOTE interface (9p SubD connector) provides *Hook* control for an external hybrid and Ring LED control capabilities.

The RECEIVE input is a female Jack 1/4" socket into which the output from an external telephone hybrid may be plugged. It is a balanced input.

The SEND output is a female Jack 1/4" socket into which may be plugged into the input of an external telephone hybrid. It is a balanced output, providing a *mix-minus* feed (i.e. the programme output signal *minus* the phone signal).

17.4 RECEIVE CONTROL

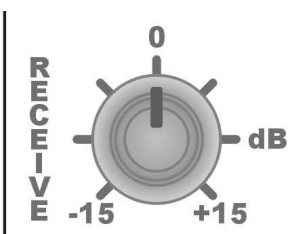

It adjusts in the +/- 15 dB range the level of the signal incoming from telephone caller via the external telephone hybrid.

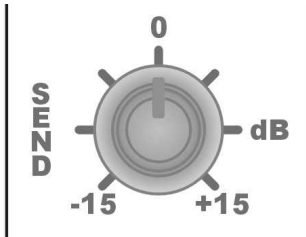
17.5 SEND CONTROL

It adjusts in the +/- 15 dB range the level of *mix-minus* signal which is sent to the telephone caller via the external telephone hybrid.

17.6 HOOK SWITCH AND RING LED

The Hook switch remotely controls the Line hooking on suitable telephone hybrids (such as Macrotel 5,7,9 and BoxTel by Axel Technology). This switch connects / disconnects the hybrid from the telephone line and **mutes the channel** (ie. when Hook is depressed, Receive input is automatically muted).

The HOOK LED switches on only with telephone line properly connected.

Ring LED blinks when a call (ring) is coming. This requires a suitable control by the external telephone hybrid (such as Macrotel 5,7,9 and BoxTel by Axel Technology). Please refer to Telco Remote Interface - par. 17.2.

If the HOOK switch is pressed with an external hybrid properly connected, the red HOOK LED will illuminate and the caller is connected to the Telco module but not yet heard in the broadcast whilst the fader is down.

By opening the fader, the Telco module will be activated and the signal will enter the program (see also MASTER/SUB switches par. 17.8 and PFL PRIVATE button par. 17.9)

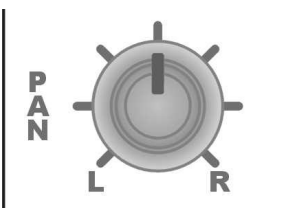
17.7 PAN

The PAN control determines the position of the signal within the stereo mix image. Rotation fully anticlockwise feeds the signal solely to the Left mix bus (Master & Sub outputs), while rotation clockwise sweeps the image to the Right mix bus (Master & Sub outputs).

The centre applies 0 dB of gain to both L & R signals.

17.8 MASTER-SUB ROUTING SWITCHES

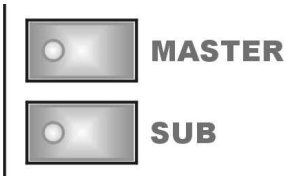

The input channel signal may be routed to the main Stereo MIX (L-R) and/or to the SUB bus by pressing the respective switches. There is a red LED inside each switch which will illuminate accordingly.

The Sub mix can be mixed into the main output mixbus (Master) (see MASTER routing switcher on the Sub module). This is a convenient way to use the SUB assignment switch as a subgroup system, creating new possibilities in the Oxygen 4 console.

17.9 PFL/PRIVATE BUTTON



Pre-fade listening PFL button (operated only in latched mode) allows a caller to listen to the **talkback** mic(s) and to be heard without being in the broadcast (i.e. with the fader closed).

When the PFL button is activated:

- the channel (Receive) signal will be connected to the PFL output and to the MONITOR meters circuitry (see also MONITOR Chapter).
- the *TalkBack To Studio* bus audio is automatically switched to the caller for “off-air” (i'Private') communications with the engineer or the announcer

It means, the presenter can talk *off-air* with a caller (whilst the Main programme is being output) via its own microphone (routed as *TB to Studio* – see par. 15.2) or the TB microphone built-in into the Monitor module (see par. 20.7 for TB built-in microphone activation).

The PFL system is always active and it operates in the ADDITIVE Mode (i.e. You can listen to one or more PFLs at the same time by selecting one or more PFL keys).

When the PFL button is deactivated:

- the Master or Sub bus is automatically sent to the caller, regardless of the Master and Sub routing switches on the Telco module
- the caller is broadcast with channel fader opened

17.10 FADER

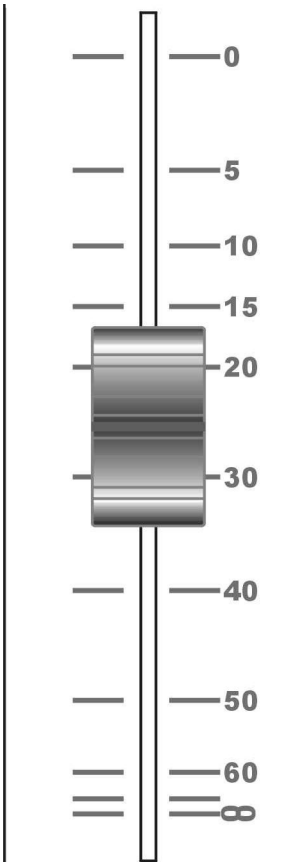

ALPS N-type 90° ultra smooth 100 mm sliders are provided on series.

The scale shows the attenuation. Normal operating position is at the top '0' mark, providing overall 0 dB of gain.

On request, to notify at order, ALPS K/VCA series sliders can be also fitted, the last ones controlling the internal high quality VCA circuitry. There is no audio going through the VCA faders. VCA faders do not therefore suffer from such severe noise and signal loss problems that conventional faders may have when wear and tear causes the resistive surface to deteriorate. The benefit is longer fader life, as the crackles and dropouts typical of the traditional audio faders are smoothed out.

18 TELEPHONE MODULE

18.1 INTRODUCTION

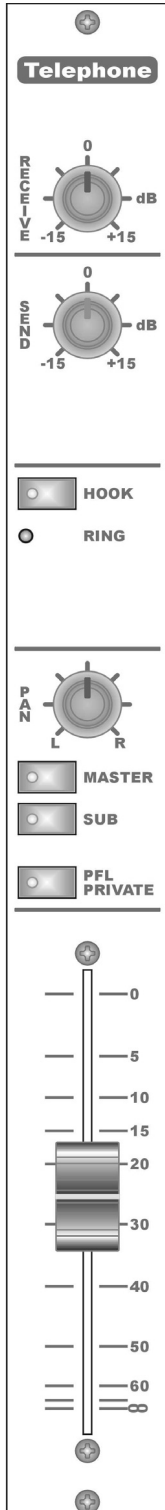

The Telephone module features a **built-in telephone hybrid**.

The module features two gain controls, PFL, Master and Sub output routing switches, hybrid Hook / Ring controls. It features connections to a regular telephone line (POTS) and to an external standard telephone set (f.i. for dialling). Automatic line compensation is featured.

The audio engineer (or the presenter) can talk *off-air* with a caller (whilst the Main programme is being output) via its own microphone (connected to Mono module and routed as *TB to Studio*) or the *TB* microphone built-in into the Monitor module.

The 'Hook' button allows Line hooking. This switch hooks / hangs up the hybrid from the telephone line. Hook LED switches on accordingly.

A '**RING**' LED is provided for signalling of incoming calls.

ALPS N-type 90° ultra smooth 100 mm sliders are provided on series. **On request, to notify at order, ALPS K/VCA** series sliders can be also fitted, the last ones controlling an internal high quality VCA circuitry.

18.2 REAR PANEL

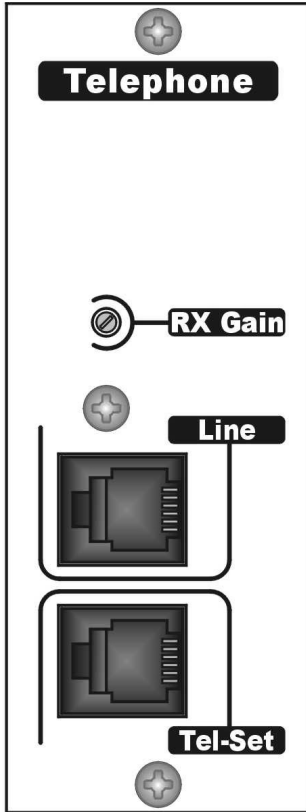

The **RX Gain** is a recessed trimmer for incoming signal fine tuning. It is recommended to adjust the trimmer for a medium 'receive' level (depending on the line characteristics) and act on the Receive knob on the module front panel for 'on-the-fly' adjustments.

LINE: RJ11 socket for telephone line connection

NOTE: Oxygen 4 Telephone hybrid operate on **standard POTS** (Plain Old Telephone Service) / **PSTN** (Public Switched Telephone Network) analog telephone lines.

The **TEL SET** socket allows the connection on parallel of a standard telephone set (f.i. for dialling services). Please note that 'TEL SET' socket is always active (i.e. it doesn't depend on the 'Hook' button state).

The two RJ11 connectors will accept 4 wires modular plugs, but only the 2 central wires (typically Red & Green) are used.

18.3 RECEIVE CONTROL

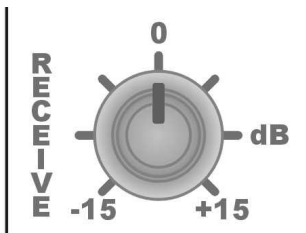

It adjusts in the +/- 15 dB range the level of the signal incoming from telephone caller.

18.4 SEND CONTROL

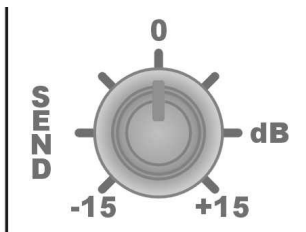

It adjusts in the +/- 15 dB range the level of *mix-minus* signal which is sent to the telephone caller.

18.5 HOOK SWITCH AND RING LED



The HOOK switch hooks / hangs up the hybrid from the telephone line. Hook LED switches on accordingly.

RING LED blinks when a call (ring) is coming in. Please note: LED glows only if phone line is connected.

18.6 PAN CONTROL

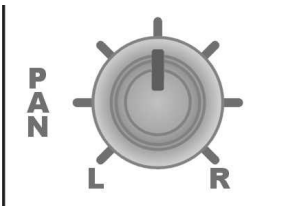

The PAN control determines the position of the signal within the stereo mix image. Rotation fully anticlockwise feeds the signal solely to the Left mix bus (Master & Sub outputs), while rotation clockwise sweeps the image to the Right mix bus (Master & Sub outputs). The centre applies 0 dB of gain to both L & R signals.

18.7 MASTER-SUB ROUTING SWITCHES



The input channel signal may be routed to the main Stereo MIX (L-R) and/or to the SUB bus by pressing the respective switches.

There is a red LED inside each switch which will illuminate accordingly.

The Sub mix can be mixed into the main output mixbus (Master) (see MASTER routing switcher on the Sub module). This is a convenient way to use the SUB assignment switch as a subgroup system, creating new possibilities in the Oxygen 4 console.

18.8 PFL/PRIVATE BUTTON



Pre-fade listening PFL button (operated only in latched mode) allows a caller to listen to the **talkback** mic(s) and to be heard without being in the broadcast (i.e. with the fader closed).

When the PFL button is activated:

- the channel (Receive) signal will be connected to the PFL output and to the MONITOR meters circuitry (see also MONITOR Chapter).
- the *TalkBack To Studio* audio bus is automatically switched to the caller for “off-air” (i.e. ‘Private’) communications with the engineer or the announcer

I.e., the engineer can talk *off-air* with a caller (whilst the Main programme is being output) via its own microphone (routed as *TB to Studio* – see par. 15.2) or the TB microphone built-in into the Monitor module (see par. 20.7 for TB built-in microphone activation).

The PFL system is always active and it operates in the ADDITIVE Mode (i.e. You can listen to one or more PFLs at the same time by selecting one or more PFL keys).

When the PFL button is deactivated:

- the Master or Sub bus is automatically sent to the caller, regardless of the Master and Sub routing switches on the module
- the caller is broadcast with channel fader opened

18.9 FADER

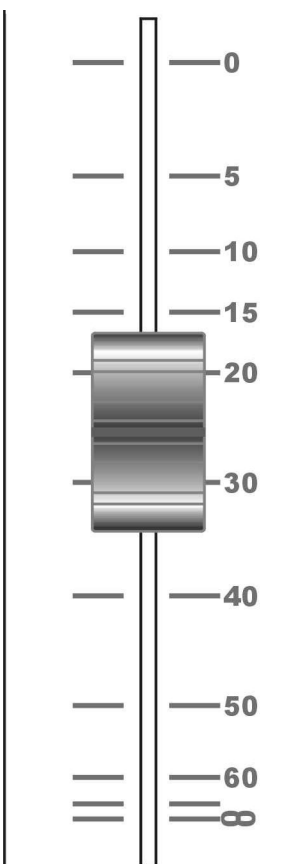

ALPS N-type 90° ultra smooth 100 mm sliders are provided on series.

The scale shows the attenuation. Normal operating position is at the top '0' mark, providing overall 0 dB of gain.

On request, to notify at order, ALPS K/VCA series sliders can be also fitted, the last ones controlling an internal high quality VCA circuitry. There is no audio going through the VCA faders. VCA faders do not therefore suffer from such severe noise and signal loss problems that conventional faders may have when wear and tear causes the resistive surface to deteriorate. The benefit is longer fader life, as the crackles and dropouts typical of the traditional audio faders are smoothed out.

19 MASTER - SUB MODULE

19.1 INTRODUCTION

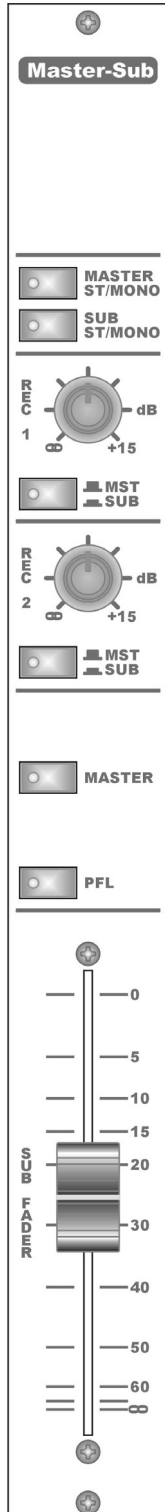

Master-Sub module contains both Master and Sub **main outputs**.

It provides also two stereo outputs (Rec 1 and Rec 2) that can be configured to operate in either of two modes: as a second SUB output or as a second MASTER output (f.i. serving as a second stereo output for on-air use).

As well as having its own independent output with overall Fader control, the Sub signal can be also routed to the main (Master) programme output, allowing it to be used as audio subgroup primarily for production applications.

The pre-fader Sub signal is also available for monitoring.

Both the Master and Sub Main outputs can be independently switched in Mono mode.

19.2 REAR PANEL

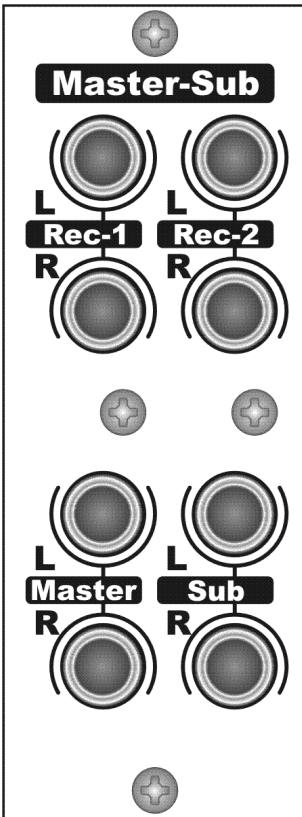

All the outputs are electronically balanced, have a nominal level of 0 dBu, and can drive balanced or unbalanced loads of 600 ohms or greater. To connect to an unbalanced load connect the tip to high (+ or hot), and both the ring and sleeve to shield.

Rec 1 and Rec-2 outputs copy Master or Sub outputs on independent drivers, depending on the REC control switchers (see).

Master and Sub sockets provide the **main console outputs** (stereo Master and Sub).

Refer to Chapter 0 for connections.

19.3 STEREO / MONO MODE SWITCHERS

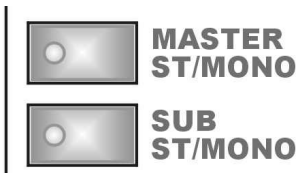

Two push-buttons activate the monaural function on Master and Sub outputs. The switch is set for latching operation; press once to active mono, press again to go back to stereo.

An LED, located directly in the switch, displays mono status. The mono function sums (adds) the left and right channels, drops the level 6dB, and sends the resulting signal to both the left and right Master (or Sub) outputs.

The mono feed is usually used as the main output if you are broadcasting in mono, or have an AM service.

19.4 REC 1 CONTROL SECTION

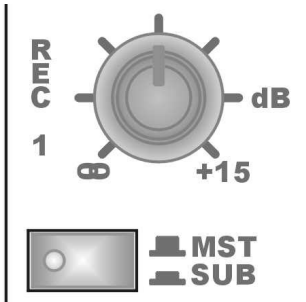

The REC 1 stereo output is sourced from the main Master bus or Sub Bus depending on the MST/SUB switch selection.

The REC 1 potentiometer controls the level of the MST / SUB signal sent to REC 1 L&R connectors situated on the module back panel.

19.5 REC 2 CONTROL SECTION

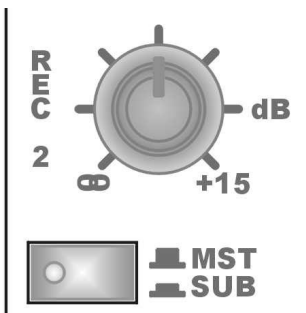

The REC 2 stereo output is sourced from the main Master bus or Sub Bus depending on the MST/SUB switch selection.

The REC 2 potentiometer controls the level of the MST / SUB signal sent to REC 2 L&R connectors situated on the module back panel.

19.6 MASTER ROUTING SWITCH



MASTER routing switcher allows the Sub mix (post-fader) to be mixed into the main output mixbus (Master). This is a convenient way to use the SUB assignment switch as a subgroup system, creating new possibilities in the Oxygen 4 console.

The red LED inside the switch will illuminate accordingly.

19.7 PFL BUTTON



Stereo pre-fade listening. PFL button (operated only in latched) mode allows pre-fade listening of the SUB channel with the fader closed. When the PFL button is activated, the Sub signal will be connected to the PFL output and to the MONITOR meters circuitry (see also MONITOR Chapter).

Even when the channel is active, the PFL system is active. It always operates in the ADDITIVE Mode (i.e. You can listen to one or more PFLs at the same time by pressing one or more PFL keys).

19.8 SUB FADER

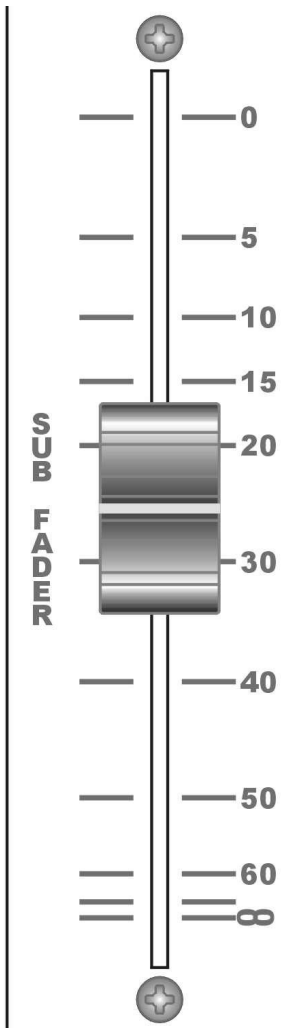

ALPS N-type 90° ultra smooth 100 mm sliders are provided on series.

The scale shows the attenuation. Normal operating position is at the top '0' mark, providing overall 0 dB of gain.

20 MONITOR MODULE

20.1 INTRODUCTION

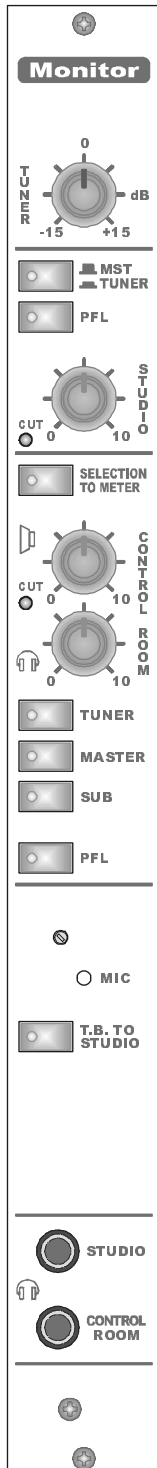

The Oxygen 4's monitor section gives the operator an extensive set of resources.

In addition to monitoring the Master and Sub audio buses, provision has been made for monitoring an external audio source. This stereo input (Tuner) is intended to be connected to microwave, FM or satellite receivers or another studio. Tuner Input is electronically balanced.

The Studio and Control Room allow monitoring of selected buses (Tuner, Master, Sub and PFL) without interfering with normal operation of the main audio bus. For operator assistance, the *Monitor* meters can be configured to monitor these buses whenever the *Selection To Meter* function is active in the Control Room section.

The **Studio monitor** section is capable of driving one pairs of high-impedance headphones plus a *speaker* output as well as two pairs of high-impedance headphones (the selection is via jumpers).

The **Control Room monitor** section is capable of driving one pairs of high-impedance headphones plus a *speaker* output with separated level controls.

Speakers outputs are stereo line-level outputs, provided for connection to a power amplifier associated with loudspeakers.

Both the Studio and Control Room loudspeakers circuits can be cut by one of the console's internal mute busses (see MONO module setting options).

The **TALK BACK TO STUDIO** button allows people in the Control Room to transmit talkback to the Studio Speakers and Studio headphones when the button is pressed and vice versa (i.e. TB button allows communications from Studio to Control Room Headphones and Speakers, too).

An user-enabled, built-in microphone (with its own level-adjustment) is also provided for this aim.

20.2 MODULE OPTIONS AND JUMPER SETTINGS

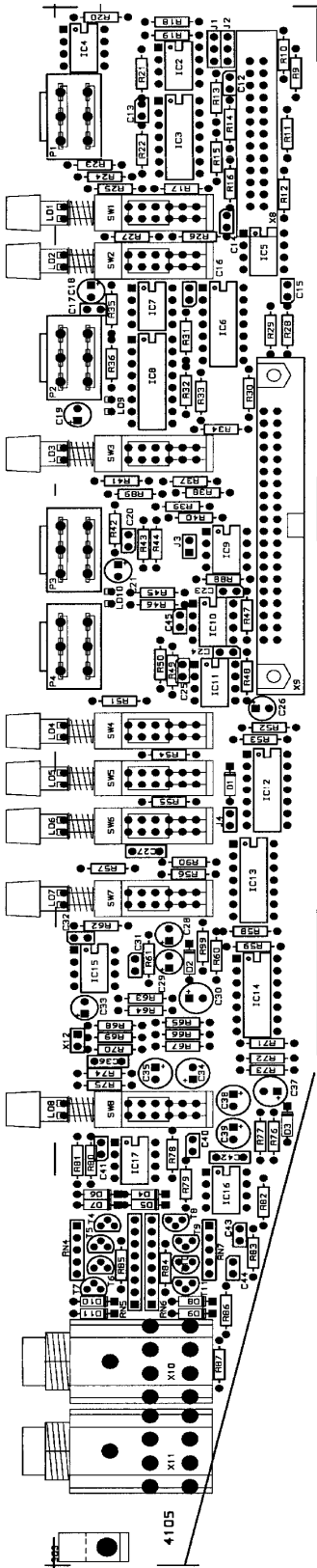

There are four Jumpers on the Monitor module PCB.

J1 and **J2** are situated on the top of the module (near to the Tuner potentiometer)

J3 is situated near to the 'flat cable' connector (behind the Ctrl Room speaker potentiometer)

J4 is situated behind the Control Room SUB switch.

The jumper settings are given below:

The **J1** and **J2** jumper settings allow you to configure each of the left and right outputs of the back-panel STUDIO outputs to either Line level (i.e. suitable for an external amplifier) or to headphone level (ref par. 20.3).

J1-J2		SPEAKER SIGNAL ON STUDIO OUT
J1-J2		HEADPHONES SIGNAL ON STUDIO OUT

When closed, the **TB MIC** jumper (**J3**) enables the console built-in microphone for TalkBack to Studio communications.

J3		MONITOR MIC ENABLE
----	--	-----------------------

When the jumper **J4** is closed, the TalkBack to Studio button is associated to the cut-off of the **C.ROOM SPEAKER** output on the MONITOR module.

J4		AUTOMATIC C.ROOM SPEAKER MUTE WHEN TB IS ENABLED
----	--	--

20.3 REAR PANEL CONNECTIONS

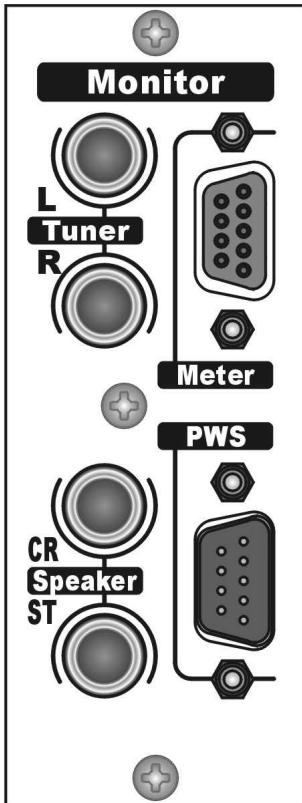

Oxygen 4's rear panel contains the following connections:

TUNER

These 1/4" plugs contain the balanced stereo External Input for the Studio and Control Room listening.

CR / STUDIO SPEAKER / HEADPHONES

The Oxygen 4 contains 2 headphone output jacks (Studio and Control Room) on the front panel.

On the back panel, Control Room output is factory-preset for connection to audio power amplifiers associated with a pair of monitor loudspeakers**, while the Studio output may be set as secondary Headphone output or as Speaker output (via an external amplifier).

The simplest way of using the Studio headphone output is therefore simply to plug a pair of headphones into the front panel jack. For improved system flexibility, it may be convenient to set back panel output as an additional Studio headphone output. Settings are done via two internal Jumpers on the PCB (ref to previous paragraph).

** or amplified speakers that contain internal power amplifiers.

PWS (DC POWER)

This is male SubD 9 pin socket which connects the Oxygen 4 mixer to the power supply.

METER

This is female SubD 9 pin socket which connects the Oxygen 4 mixer to the Meterbridge.

20.4 TUNER LEVEL CONTROL

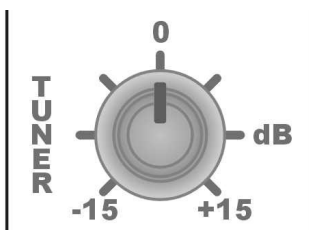

This control allows you to adjust the level of the External Input signal to be monitored by the Studio/Control Room speakers and phones.

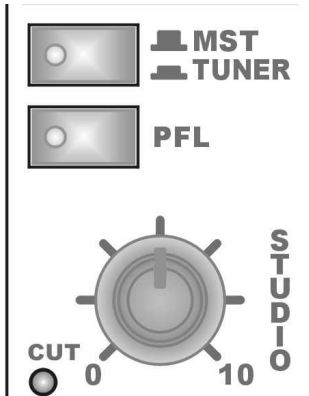
20.5 STUDIO MONITOR SECTION

Signals to be monitored by the studio monitors and / or headphones (see Jumper J 1 and J 2 - par. 20.2) are selected by using the buttons at the top of the panel. They can be used to select Master (MST) or Tuner sources, as well as PFL bus.

The PFL switch allows the normal monitor source to be interrupted and the PFL signal monitored in its place.

In particular, when the PFL button in the Studio section is pressed but no PFL signal comes from the input modules, the Studio outputs still reproduce Tuner or Master signals. You may regard this as the PFL routing circuit being armed but not active. To make it active, the PFL must be engaged in at least one of the input modules.

The STUDIO rotary control will affect the output to any headphones connected to the 1/4" jack STUDIO phones socket at the bottom of the module as well as the Speaker/Headphones Studio output on the rear panel.

The CUT LED is lit whenever the *mute* function (on Studio speaker only) is active (ref to MONO Module settings - par. 15.2) *. For normal Studio speaker operation the mute LED must not be lit.

* *Speakers full muting may be required when a "live" microphone is located in the Studio.*

20.6 CONTROL ROOM MONITOR SECTION

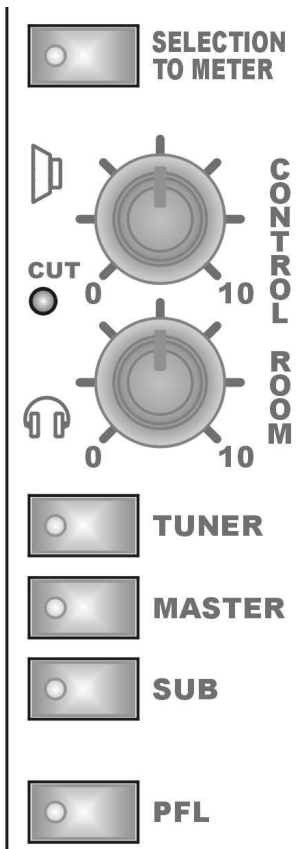

The **Selection To Meter** button determines what is shown on the *Monitor* meters.

When the button is released, the PFL signal only is shown at the meters.

With the button pressed and the LED illuminated, the levels of Tuner, Master or Sub signals can be displayed, depending on the selected source in the Control Room Monitor section. For example, if *Selection To Meter* is selected for the meters, and the Control Room has *Tuner* selected, then the meters will display the *Tuner* signal.

Switches at the bottom of the section allow selection of one (or more) of the four **Tuner**, **Master**, **Sub** and **PFL** signals as the *Control Room* source.

The PFL switch allows the normal monitor source to be interrupted and the PFL signal monitored in its place.

In particular, when the PFL button in the Ctrl Room section is pressed (Red light illuminated) but no PFL signal comes from the input modules, the Ctrl Room outputs still reproduce Tuner / Master / Sub signals. You may regard this as the PFL routing circuit being armed but not active. To make it active, the PFL must be engaged in at least one of the input modules. When PFL is active, the LEDs inside Master, Tuner and Sub buttons turn off.

Two smooth-feeling rotary controls allow the levels to be separately adjusted on the Headphones plug (at the bottom of the module) and on the Speaker output (back panel).

The control room CUT LED is lit whenever the mute function (on Ctrl Room speakers only) is active (ref to MONO Module settings - par. 15.2)**. For normal control room speaker operation the mute LED must not be lit.

** *Speakers full muting may be required when a "live" microphone is located in the control room.*

20.7 TB to STUDIO BUTTON AND TB MICROPHONE

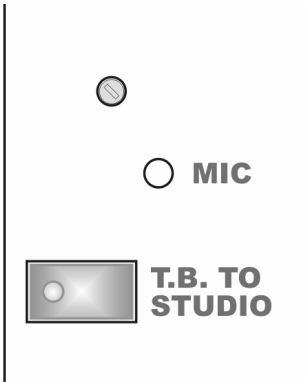

The **TALK BACK** button allows people in the Control Room to transmit talkback to the Studio Speakers and Studio headphones when the button is pressed and vice versa (i.e. TB button allows communications from Studio to Control Room Headphones and Speakers, too). The small hole located close to the MIC contains a trimmer for mic level adjustment.

When pressing Talk button:

- talkback signal toward CRoom speakers / headphones comes from all the MONO modules with 'TB to Croom' option enabled

- talkback signal toward Studio speakers / headphones comes from all the MONO modules with 'TB to Studio' option enabled as well as from the Monitor module built-in microphone whether enabled (ref to Section 20.2 for internal Microphone enabling).

C ROOM SPEAKERS	Talkback source will automatically replace their existing sources. <u>Speakers may be muted at all</u> (CUT LED glows) with TB button pressed (ref to Section 20.2 - Jumper J 4).
C ROOM HEADPH.	Talkback source will automatically replace their existing sources.
STUDIO SPEAKERS	Talkback source will automatically replace their existing sources
STUDIO HEADPH.	Talkback source will automatically replace their existing sources.

CRoom/Studio speakers & headphones outputs are driven pre - their volume controls, so communication is possible only with volume raised..

Example 1

Communication from the audio engineer to the announcer's headphones (situated in the Studio booth) will be enabled in the following way:

- 1) Close the Jumper 'TB to Studio' on the MONO module connected to a Croom's microphone. Alternatively, the audio engineer may use the microphone built-in in the Monitor module (after enabling it via jumper).
- 2) Press and hold the *T.B. to Studio* button: it will connect the Engineer's voice audio source to the Studio headphone output. The voice audio signal will replace whatever signals are also existent on the HP output.

Example 2

Communication from the announcer (situated in the Studio booth) and the audio engineer (via C Room speakers) will be enabled in the following way:

- 1) Close the Jumper 'TB to Croom' on the MONO module connected to the Studio announcer's microphone

2) Press and hold the *T.B. to Studio* button: it will connect the Announcer's voice audio source to the CRoom speakers. The voice audio signal will replace whatever signals are also present on this output.

20.8 STUDIO AND CTRL ROOM PHONE PLUGS

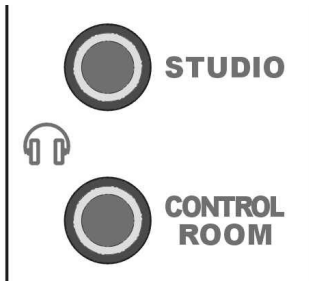

The 1/4" stereo jack sockets provide separate outputs for the Studio and Control Room phones outputs. Studio headphones can also be plugged into the back panel of this module (*Speaker* output, whenever set for headphones level – see par. 20.2).

21 POWER SUPPLY

21.1 FRONT VIEW

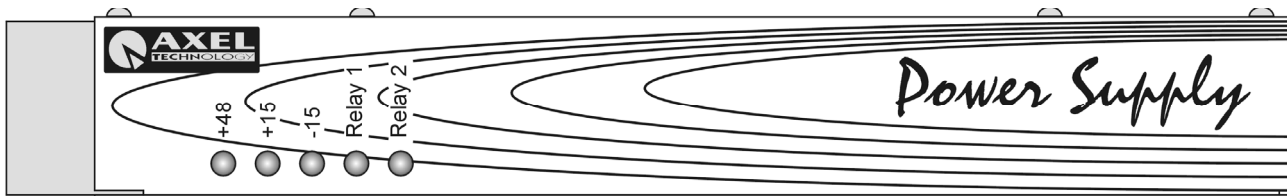

21.2 REAR VIEW

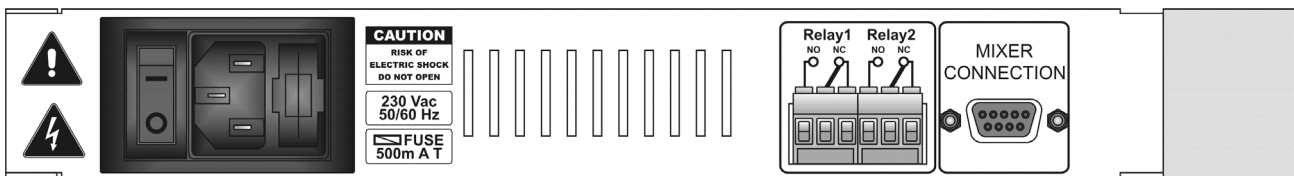

21.3 DESCRIPTION

The Oxygen 4 Power Supply (PWS) consists of a power transformer, selectable for 115 VAC or 230 VAC operation, rectifiers, filter capacitors and voltage regulators on a circuit board.

The power supply is protected by a replaceable AC mains fuse located in the power entry socket plus internal fuses on the transformer's secondary outputs and self-protected current-limiting regulators.

The power supply has three output voltages:

- +/-15 volts for the audio circuitry
- +48 volts phantom for condenser microphones.

Three LEDs on the front of the unit indicate whether the power to the three voltage rails is being supplied correctly. If one of the LED's fails, then there is a problem with the PWS unit or the console. Ref to par. 21.7

The power supply should be installed where there is **adequate ventilation** for heat to circulate from the rear and the side of the unit. In the event of PWS rack-mounting, other equipment in the rack which is known to produce a significant amount of heat should be mounted not closed to the unit (i.e. some space should be provided between these and the Oxygen 4 Power Supply).

The PWS may be rack-mounted through the supplied supports.

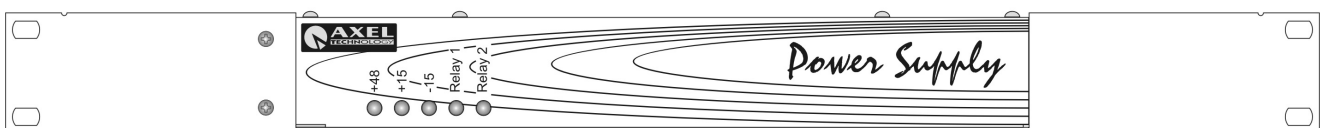

21.4 PWS RELAYS

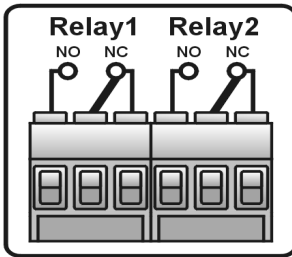

The power supply features two built-in relays separately controlled by the MONO modules.

They are designed to illuminate external Studio and/or Control Room Warning/On Air lights (such as Mr Light by Axel Technology) showing that one or more microphones are 'on air'.

Relays are intended for **low voltage** electric loads (e.g. 24 V), **up to 10 A**.

FOR SAFETY AND TO PROTECT THE OPERATOR FROM HIGH VOLTAGE SHOCK, NEVER CONNECT AC MAINS TO PWS RELAYS.

Use relays to directly control low-voltage lamps or to drive 220 / 115 Vac Lamps via external relays or optocouplers.

The Oxygen 4's PWS relays feature either Normally Open or Normally Closed contacts. Two LEDs on the front of the unit indicate whether the relays are closed.

21.5 MIXER CONNECTION



A cable with a 9 pins subD plug on each end comes with the console. It is used to connect the power supply to the mixer.

Plug the cable into the power supply MIXER CONNECTION socket. Press the plug into the socket, and screw on the locking ring to hold it firmly in place. Plug and secure the other end into the console PWS socket on *Monitor* module.

Turning the Console On or Off: First check that the mains and DC leads are correctly plugged in and secured. Turn on the power supply using its rear panel mains switch. The console must be connected to the power supply before turning it on. To avoid loud pops in the speakers make sure that the connected power amplifiers are turned off before switching the console on or off.

21.6 MAIN AC VOLTAGE SETTINGS

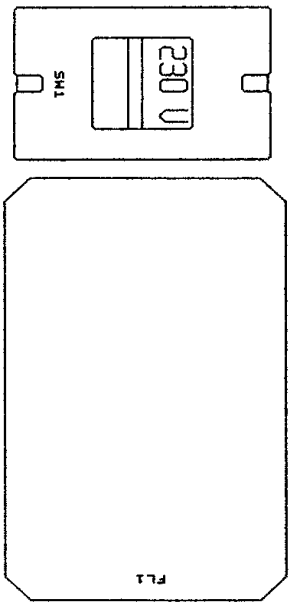

Before connecting the Oxygen 4 to mains power, determine the actual mains voltage and confirm that the Oxygen 4 has been configured correctly. As could be expected, an incorrect mains configuration could seriously damage the unit.

If the unit is to be used with a mains voltage different to that for which the unit is supplied, set the **voltage change-over switch**, which is placed inside the box, closed to the AC socket and the AC filter.

The power supply socket has an integral fuse drawer containing the AC power fuse and a spare, both of the same value, rated at 500 mA T for 220/230 V AC and for 110/115 V AC tensions.

Make sure that the IEC mains plug is pressed fully into the MAINS INPUT socket.

WARNING: The power lead must be disconnected before attempting to remove the panels or cover. Removal of the panels and cover can expose dangerous voltages.

21.7 PWS TROUBLESHOOTING

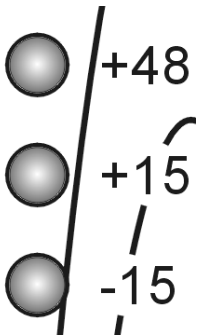

The correct operation of power supply is showed by the 3 LEDs glowing on the front panel. If the console doesn't work properly, please check the power connection cable.

If the neon lamp inside the **Main switch is off** (and therefore all LEDs on the power supply front panel are off), please check the Main Fuse next to the mains cord socket (500 mA T).

To do this:

- Switch the ON/OFF switch to the OFF position
- Remove the mains cord from the connector
- Use a small screwdriver to extract the fuse carrier drawer from its location closed to the connector
- Check the fuse and replace if necessary;
- In the event of repeated failure of the mains fuse consult the Axel Technology technical support or Yr local dealer

If one or more LED on the panel of power supply are switched off (and therefore console doesn't work properly) please execute the following steps:

- disconnect the console from the PWS
- switch the PWS on
- verify that every LED on the front panel glow (except Relay 1 and 2)

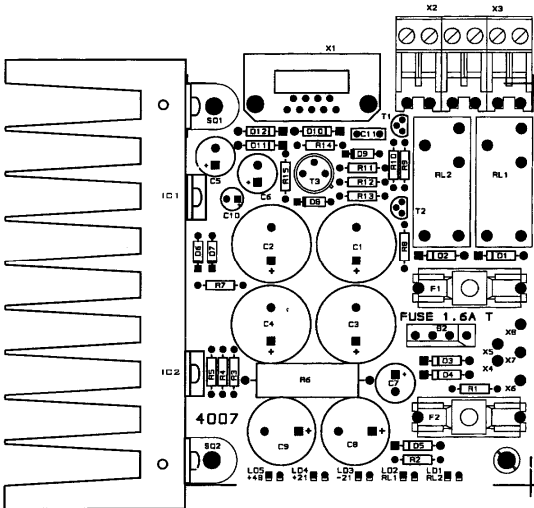

If one or more LEDs are still switched off:

- open the PWS cover
- verify the **integrity of the 2 fuses on the PCB** and replace the burned ones (fuses are rated to 1.6 A T)
- close up the cover
- connect the AC Mains cord only
- switch on the power supply again and check whether all LEDs glow. Note: if the problem still persists, please contact Axel Technology technical department
- switch the power supply off
- connect the mixing console to the PWS
- switch the PWS on
- Verify the correct mixing console operation

22 METERBRIDGE

22.1 VIEW

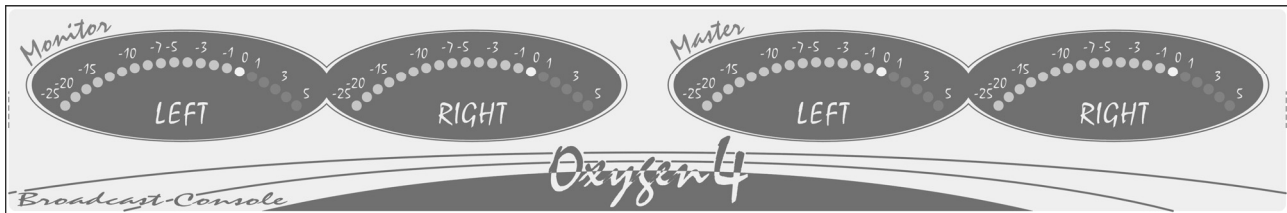

22.2 DESCRIPTION

The Oxygen 4 mixer is fitted with VU / PPM meters.

VU meters respond to an average signal level, whereas PPMs respond to peak changes (The PEAK LEDs are activated by the shortest transient peak, but remain 'on' long enough to provide easy recognition).

If a 1kHz sinusoidal signal is input to the mixer and the amplitude adjusted such that the level at the master output is 0 dBm, the meters will read 0 VU (the orange LED will glow).

The VU meters are factory-calibrated and no further user adjustment is allowed. PPM reading may be disabled (ref to next Section).

A short cable with a 9 pins subD plug on each end (male and female) comes with the console. It is used to connect the meterbridge to the mixer.

The LEFT pair of meters display PFL stereo signal, while the RIGHT pair display the Master signal.

The LEFT pair of meters can be also altered to show any combination of the Master output, the Sub output, Tuner input or whatever is selected on the **Control Room** section of **Monitor** module when the "SELECTION TO METER" button is pressed.

For example, if SELECTION TO METER is selected and the CONTROL ROOM has SUB selected, then the meters will display the SUB signal. Of course, meters will also display the PFL signal, if PFL button is selected (see par. 20.6)

22.3 METERBRIDGE SETTING

PPM reading can be disabled via the **Jumper J5** situated on the LED board inside the meterhood, behind LEFT /MONITOR scale.

VU (average) reading can never be disabled.

For Jumper setting ref. to layout scheme displayed on the next page:

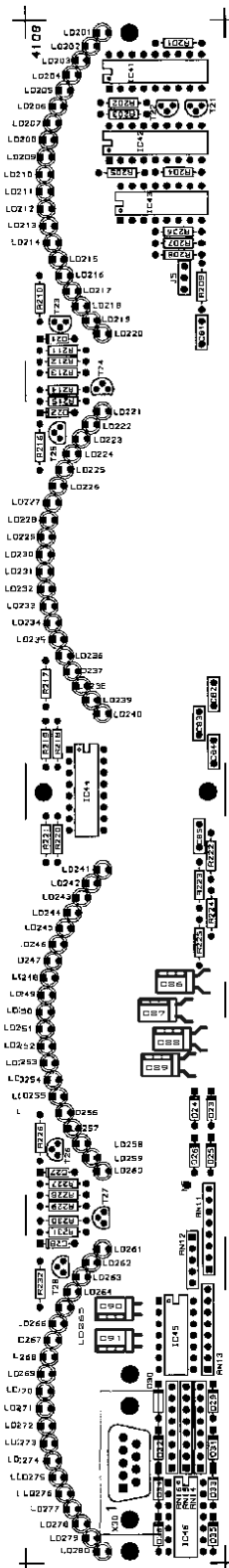

JUMPER SET	FUNCTION
J5	AVERAGE BAR + PEAK
J5	ONLY AVERAGE BAR

23 TECHNICAL SPECIFICATIONS

STEREO MODULE

INPUT A	Stereo	El. Bal.	jack 1/4"	
INPUT A nominal level	0 dBm (LINE)			-15 to +15 dB gain control
INPUT A impedance	10 kOhm			
INPUT B	Stereo		jack 1/4"	
INPUT B levels (jumper select)	0 dBm (LINE)	El. Bal		-15 to +15 dB gain control
	Phono (RIAA)	Unbal		-15 to +15 dB gain control
INPUT B line impedance	10 kOhm			

MONO MODULE

INPUT A	Mono	El. Bal.	XLR	
INPUT A adj level range	- 70 dB to - 23 dB (MICRO level)			-15 to +15 dB gain control
INPUT A insert level	0 dBm	Unbal.	jack 1/4"	
INPUT A impedance	> 1,5 kOhm			
INPUT B	Mono	El. Bal.	Jack 1/4"	
INPUT A nominal level	0 dBm (LINE)			-15 to +15 dB gain control
INPUT B impedance	10 kOhm			

TELEPHONE MODULE

SEND / RECEIVE separ.	20 dB**	<i>** it can vary depending on telephone line characteristics</i>		
In / out level on tel. line	-6 dBm on 600 Ohm line impeded.			
Compensation mode	Electronic / automatic			

TELCO MODULE

SEND Output	Mono	El. Bal.	Jack 1/4"	
SEND level	0 dBm			-15 to +15 dB gain control
RECEIVE Input	Mono	El. Bal.	Jack 1/4"	-
RECEIVE level	0 dBm			-15 to +15 dB gain control

MASTER / SUB MODULE

SUB Output	Stereo	El. Bal.	Jack 1/4"	
Nominal SUB Output Level	0 dBu (LINE)			
Max SUB Output level	+ 20,5 dBm (25 Vpp)			
SUB Output Impedance	50 Ohm			
Noise (DIN Audio)	less than - 89 dBm			
Crosstalk L/R	< - 60 dB @ 1 kHz			
THD+N	< - 73 dB @ 1 kHz			
Frequency response	20 Hz to 20 kHz (- 0.2 dB)			
MASTER Output	Stereo	El. Bal.	Jack 1/4"	
Nominal MST Output Level	0 dBu (LINE)			
Max MST output level	+ 20,5 dBm (25 Vpp)			
MST output Impedance	50 Ohm			
Noise (DIN Audio)	less than - 87 dBm			
Crosstalk L/R	< - 60 dB @ 1 kHz			
THD+N	< - 74 dB @ 1 kHz			
Frequency response	20 Hz to 20 kHz (- 0.5 dB)			
REC1 – REC2 OUTPUT	Stereo	El. Bal.	Jack 1/4"	-inf to + 15 dBm

MONITOR MODULE

TUNER IN	Stereo Line	El. Bal.	Jack 1/4"	-15 to +15 dB gain
STUDIO Output	Spk - Stereo Line	Unbal.	Jack 1/4"	-inf to +6 dBm
	Phones - Stereo Line	Unbal.	Jack 1/4"	0 to 24 Vpp (20 dBm)
CTRL ROOM Output	Spk - Stereo Line	Unbal.	Jack 1/4"	-inf to +6 dBm
	Phones - Stereo Line	Unbal.	Jack 1/4"	0 to 24 Vpp (20 dBm)

DIMENSIONS

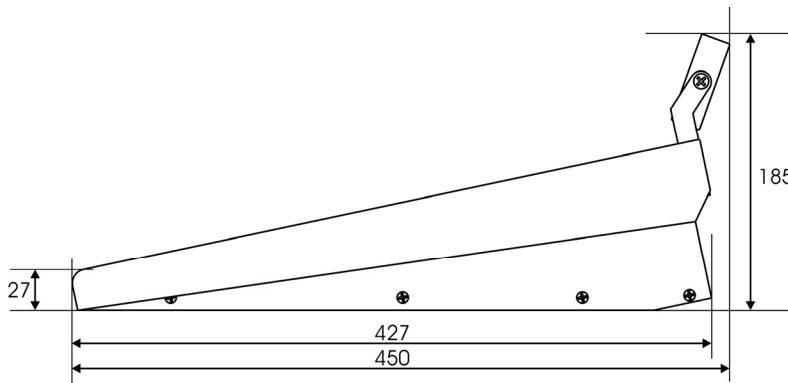

CONSOLE	OVERALL WIDTH
10 modules Frame	416 mm
20 modules Frame	802 mm
30 modules Frame (with Script Tray)	1188 mm

24 WARRANTY

The manufacturer offers a 1-year ex works warranty.
 Do not open the equipment. The warranty shall be voided if any of the warranty seals are broken.
 The manufacturer shall not be liable for damage of any kind deriving from or in relation to incorrect use of the product.