

Dolphin

Digital RDS Coder

Operating manual

(Rel. 1.5)

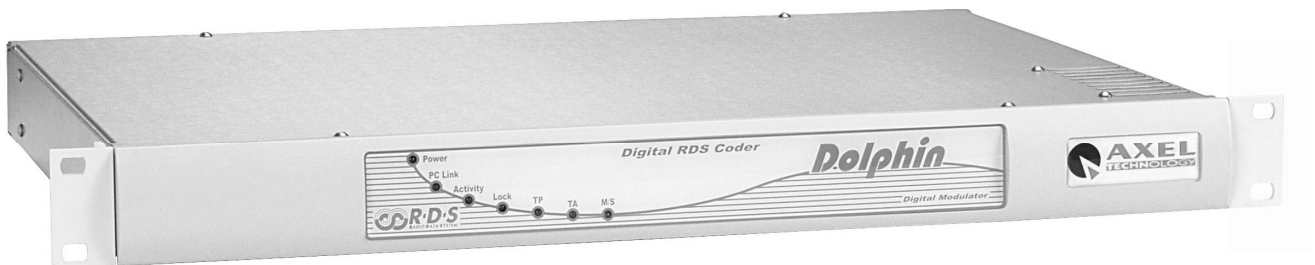

Via Caduti Di Sabbiuno 6/F - 40011 Anzola Emilia - Bologna - Italy - Tel.+39 051 736555 - Fax.+39 051 736170
e-mail: info@axeltechnology.com - web site: www.axeltechnology.com

1 TABLE OF CONTENTS

1	TABLE OF CONTENTS.....	3
2	INTRODUCTION.....	5
3	FOREWORD.....	7
4	SAFETY WARNINGS.....	8
5	CONSIGNES DE SÉCURITÉ IMPORTANTES.....	10
6	ISTRUZIONI IMPORTANTI PER LA SICUREZZA.....	12
7	WICHTIGE SICHERHEITSHINWEISE.....	14
8	INSTRUCCIONES IMPORTANTES DE SEGURIDAD.....	16
9	UNPACKING AND INSPECTION.....	18
10	FIRST INSTALLATION RECOMMENDATIONS.....	19
10.1	POWER SUPPLY CABLE.....	19
10.2	AC MAINS VOLTAGE SETTING (230 V / 115 V).....	19
10.3	FUSE REPLACEMENT.....	20
10.4	PROTECTION AGAINST LIGHTNING.....	20
10.5	VENTILATION.....	21
11	WIRING AND CONNECTIONS.....	22
11.1	SIDCHAIN MODE (SUGGESTED).....	22
11.1.1	Sidechain - SYNC mode.....	22
11.1.2	Sidechain – MPX mode.....	23
11.2	LOOP-THROUGH MODE.....	25
11.3	REMOTE INTERFACE (DIGITAL DATA PORT).....	26
11.4	THE 'SPLIT' FUNCTION.....	28
11.5	PC INTERFACE CONNECTORS.....	30
12	EQUIPMENT DESCRIPTION.....	31
12.1	FRONT PANEL LEDS.....	31
12.2	REAR PANEL.....	32
13	THE PC SOFTWARE REMOTE CONTROL.....	33
13.1	INTRODUCTION.....	33
13.2	CONTROL SOFTWARE INSTALLATION.....	34
13.3	SOFTWARE SETUP.....	35
13.4	LOAD AND SAVE FUNCTIONS.....	36
13.5	SEND PANEL / CLOSE PANEL BUTTONS.....	36
14	THE MAIN CONTROL PANEL.....	37
14.1	RDS SERVICES - QUICK SUMMARY.....	37
14.2	PS CHARACTER TABLES.....	38
14.3	RDS SYNCHRONISM SOURCE.....	38
14.4	ENABLING THE 'SPLIT' MODE.....	38
15	ALTERNATIVE FREQUENCIES LIST.....	39
15.1	AF METHODS A AND B.....	40
16	RADIOTEXT AND RT SCHEDULER.....	42
16.1	RT A/B FLAG.....	42
16.2	RT SCHEDULING PRIORITY.....	43

17	PS AND PS SCHEDULER.....	44
17.1	PS SEQUENCES.....	45
17.2	PS SCROLLING.....	46
17.3	PS PAGE SCHEDULER.....	46
18	THE I-PS OPTION.....	48
18.1	WHAT IS THE I-PS OPTION.....	48
18.2	HOW TO GET IT.....	48
18.3	THE DYNAMIC PS PANEL - INTRO.....	49
18.4	'ON THE FLY' PS SEQUENCES.....	50
18.5	PS SCROLLING.....	51
18.6	THE DJ REMOTER.....	52
19	ASCII-HEX PROTOCOL DEFINITION (PARSER ASCII - REL 1.1).....	53
19.1	BAUD RATE AND SERIAL PORT SETTINGS.....	53
19.2	COMMAND AND STRING DELIMITERS.....	53
19.3	STRING DELIMITERS.....	53
19.4	SUB-FIELD (PARAMETER) DELIMITERS.....	53
19.5	UNVALID CHARACTERS.....	53
19.6	TIMEOUTS.....	53
19.7	COMMAND SET.....	54
19.8	STRING SEQUENCE.....	55
19.9	ERROR SUMMARY.....	55
20	HINTS AND TIPS ABOUT DYNAMIC PS MODE.....	56
21	FIRMWARE UPGRADE.....	57
22	TECHNICAL SPECIFICATIONS.....	60

2 INTRODUCTION

Thank you for choosing this easy to use, dynamic RDS encoder which supports all services and features in common use. Its specifications and operation have been accurately designed to satisfy the most demanding requirements in the RDS generation and broadcasting.

Its state-of-art, high-speed DSP technology ensures the purest modulation quality (the whole processing is performed by phase linear filters). Digital architecture also guarantees long term reliability and easy firmware updates.

A powerful Pc control software comes with the unit. It allows control and setting in an easy and intuitive way of all RDS data and of signal generation parameters (level and phase, synchronism source, etc). The basic software screen always displays, in real time, PS and RT content currently on air, allowing a full and immediate monitor of RDS broadcasting, even when a FM tuner is not available.

A software module available as an option (**i-PS** technology) further boosts new PS management features: it eliminates every PS programming constraint and leaves the maximum freedom in terms of message length, save / recalling facilities and message editing masks. Any text can be entered and broadcast 'on-the-fly' both as a full PS sequence or in a scrolling mode.

Furthermore, featuring a true ASCII communication protocol, **i-PS** software module enables the coder to be easily and quickly interfaced to any hard disk automation systems, for song and artist identification on PS fields and much more...!

Highlights:

- Full-Digital RDS coder
- Total software remote control
- Advanced dynamic PS management (**i-PS** technology)
- Easy interface to hard disk automation systems
- RDS characters customizable for different countries
- Dedicated sw interface for DJ and announcers

OPTIONS AVAILABLE:

i-PS: software + firmware module for advanced management of up to 384 dynamic PS (includes software dedicated interface for DJ and ASCII programming support)

SPLIT: The RDS SPLIT mode allows the RDS encoder output to toggle between an external RDS signal applied to AUX 1 input and the RDS signal internally generated.

USB: Communication interface 1 USB + 1 RS-232 port



This product has been
developed in collaboration with
Audio Devices
Hardware & Software Engineering

SAFETY WARNINGS

CONSIGNES DE SÉCURITÉ IMPORTANTES

ISTRUZIONI IMPORTANTI PER LA SICUREZZA

WICHTIGE SICHERHEITSHINWEISE

INSTRUCCIONES IMPORTANTES DE SEGURIDAD

(Rel. 1.0)

3 FOREWORD

For your own safety and to avoid invalidation of the warranty all text marked with these Warning Symbols should be read carefully.



Information in this manual is subject to change without notice and does not represent a commitment on the part of the vendor.

The manufacturer shall not be liable for any loss or damage whatsoever arising from the use of information or any error contained in this manual, or through any mis-operation or fault in hardware contained in the product.

It is recommended that all maintenance and service on the product should be carried out by the manufacturer or its authorised agents. The manufacturer cannot accept any liability whatsoever for any loss or damage caused by service, maintenance or repair by unauthorised personnel.





4 SAFETY WARNINGS

The installation and servicing instructions in this manual are for use by qualified personnel only.

- **Read All Instructions.** All safety and operating instructions must be read before operating the product. They also must be retained for future reference, as it contains a number of useful hints for determining the best combination of equipment settings for Yr particular application.
- **Heed All Warnings.** All warnings on the product and those listed in the operating instructions must be adhered to.
- **Heat.** This product must be situated away from any heat sources such as radiators or other products (including power amplifiers or transmitters) that produce heat.
- **Power Sources.** This product must be operated from the type of power source indicated on the marking label and in the installation instructions. If you are not sure of the type of power supplied to your facility, consult your local power company. Make sure the AC main voltage corresponds to that indicated in the technical specifications. If a different voltage (ex. 110/115 VAC) is available, open the equipment closure and set the voltage switch on the main supply circuit, located behind the AC socket
- **Power Cord Protection.** Power supply cords must be routed so that they are not likely to be walked on nor pinched by items placed upon or against them. Pay particular attention to the cords at AC wall plugs and convenience receptacles, and at the point where the cord plugs into the product
- Clean only with dry cloth
-  Use only with a cart, stand, tripod, bracket, or table specified by the manufacturer, or sold with the apparatus. When a cart is used, use caution when moving the cart/apparatus combination to avoid injury from tip-over.
- **Lightning.** For added protection for this product during a lightning storm, or when it is left unattended and unused for long periods of time, unplug it from the AC wall outlet and the audio connections. This will prevent damage to the product due to lightning and power line surges
- **Installation.** Configuration and installation should only be carried out by a competent installation engineer
- **Cabling.** Using high quality wires, well protected. Make sure the cable integrity.
- **Equipment design.** This manual images could differ a bit from the equipment actual design

	<p>This symbol alerts you to the presence of dangerous voltage inside the closure – voltage which may be sufficient to constitute a risk of shock. Do not perform any servicing other than that contained in the operating instructions. Refer all servicing to qualified personnel</p>
---	---

	<p>The exclamation point within an equilateral triangle is intended to alert the user to the presence of important operating and maintenance (servicing) instructions in the literature accompanying the appliance.</p>
---	---





	<p>Do not change the voltage setting or replace the mains fuse without first turning the unit off and unplugging the mains cord.</p>
	<p>This apparatus must be EARTHED !</p>
	<p>To avoid risk of fire use the correct value fuse, as indicated on the label stuck on the right side of the unit.</p>
	<p>Make sure the AC main voltage corresponds to that indicated in the technical specifications.</p>
	<p>This apparatus uses a single pole mains switch and does therefore not separate the unit completely from the mains power. To completely separate from mains power (f.i. in the event of danger) unplug mains power cord. As the MAINS plug as the disconnect device, the disconnect device shall remain readily operable.</p>

5 CONSIGNES DE SÉCURITÉ IMPORTANTES

- Lire ces consignes
- Conserver ces consignes
- Observer tous les avertissements
- Suivre toutes les consignes
- Ne pas utiliser cet appareil à proximité de l'eau
- Nettoyer uniquement avec un chiffon sec
- Ne pas obstruer les ouvertures de ventilation. Installer en respectant les consignes du fabricant
- Ne pas installer à proximité d'une source de chaleur telle qu'un radiateur, une bouche de chaleur, un poêle ou d'autres appareils (dont les amplificateurs) produisant de la chaleur.
- Ne pas annuler la sécurité de la fiche de terre, la troisième branche est destinée à la sécurité. Si la fiche fournie ne s'adapte pas à la prise électrique, demander à un électricien de remplacer la prise hors normes.
- Protéger le cordon d'alimentation afin que personne ne marche dessus et que rien ne le pince, en particulier aux fiches, aux prises de courant et au point de sortie de l'appareil
- Utiliser uniquement les accessoires spécifiés par le fabricant
-  Utiliser uniquement avec un chariot, un support ou une table spécifié par le fabricant ou vendu avec l'appareil. Si un chariot est utilisé, déplacer l'ensemble chariot–appareil avec précaution afin de ne pas le renverser, ce qui pourrait entraîner des blessures
- Débrancher l'appareil pendant les orages ou quand il ne sera pas utilisé pendant longtemps.
- Confier toute réparation à du personnel qualifié. Des réparations sont nécessaires si l'appareil est endommagé d'une façon quelconque, par exemple: cordon ou prise d'alimentation endommagé, liquide renversé ou objet tombé à l'intérieur de l'appareil, exposition de l'appareil à la pluie ou à l'humidité, appareil qui ne marche pas normalement ou que l'on a fait tomber.
- NE PAS exposer cet appareil aux égouttures et aux éclaboussures. Ne pas poser des objets contenant de l'eau, comme des vases, sur l'appareil

	Ce symbole indique la présence d'une tension dangereuse dans l'appareil constituant un risque de choc électrique.
---	---

	Ce symbole indique que la documentation fournie avec l'appareil contient des instructions d'utilisation et d'entretien importantes.
---	---





	Avant de modifier le commutateur de changement de tension ou remplacer le fusible il faut débrancher l'appareil de la prise électrique
	Pendant son usage, l'appareil doit être branché à la prise de terre
	Utiliser le fusible principal AC avec la valeur qui est indiquée sur l'étiquette collée sur le coffret.
	Assurez-vous que la tension principale AC correspond à celle indiquée dans les spécifications techniques.
	L'interrupteur d'alimentation interrompt un pôle du réseau d'alimentation excepté le conducteur de terre de protection. En cas de danger, débrancher le cordon d'alimentation. Parce que la prise du réseau de alimentation est utilisée comme dispositif de déconnexion, ce dispositif doit demeurer aisément accessible.

6 ISTRUZIONI IMPORTANTI PER LA SICUREZZA

- Leggere le presenti istruzioni
- Conservare queste istruzioni
- Osservare tutte le avvertenze
- Seguire scrupolosamente tutte le istruzioni
- Non usare questo apparecchio in prossimità di acqua
- Pulire l'apparecchio solo con un panno asciutto.
- Non ostruire alcuna apertura per il raffreddamento. Installare l'apparecchio seguendo le istruzioni
- Non installare l'apparecchio accanto a fonti di calore quali radiatori, aperture per l'afflusso di aria calda, forni o altri apparecchi (amplificatori inclusi) che generino calore
- Non rimuovere il terminale di connessione a terra sul cordone di alimentazione: esso ha lo scopo di tutelare l'incolumità dell'utilizzatore. Se la spina in dotazione non si adatta alla presa di corrente, rivolgersi ad un elettricista per far eseguire le modifiche necessarie.
- Evitare di calpestare il cavo di alimentazione o di comprimerlo, specialmente in corrispondenza della spina e del punto di inserzione sull'apparato.
- Utilizzare solo dispositivi di collegamento e gli accessori specificati dal produttore.
-  Utilizzare l'apparecchio solo con un carrello, un sostegno, una staffa o un tavolo di tipo specificato dal produttore o venduto insieme all'apparecchio. Se si utilizza un carrello, fare attenzione negli spostamenti per evitare infortuni causati da ribaltamenti del carrello stesso
- Scollegare l'apparecchio dalla presa di corrente durante i temporali o quando inutilizzato a lungo
- Per qualsiasi intervento, rivolgersi a personale di assistenza qualificato. È necessario intervenire sull'apparecchio ogniqualvolta si verificano danneggiamenti di qualsiasi natura. Ad esempio, la spina o il cavo di alimentazione sono danneggiati, è entrato liquido nell'apparecchio o sono caduti oggetti su di esso, l'apparecchio è stato esposto alla pioggia o all'umidità, non funziona normalmente o è caduto.
- Non esporre a sgocciolamenti o spruzzi. Non appoggiare sull'apparecchio oggetti pieni di liquidi, ad esempio vasi da fiori.

	<p><i>Questo simbolo indica la presenza di alta tensione all'interno dell'apparecchio, che comporta rischi di scossa elettrica.</i></p>
---	---

	<p><i>Questo simbolo indica la presenza di istruzioni importanti per l'uso e la manutenzione nella documentazione in dotazione all'apparecchio.</i></p>
---	---





	Non sostituire il fusibile o cambiare la tensione di alimentazione senza aver prima scollegato il cordone di alimentazione.
	L'apparato deve essere connesso a terra durante il suo utilizzo.
	Sostituire il fusibile generale con uno di identico valore, come indicato sulla etichetta applicata sul mobile dell'apparato.
	Assicurarsi che la tensione di rete corrisponda a quella per la quale è configurato l'apparecchio.
	Questo apparato utilizza un interruttore di alimentazione di tipo unipolare e l'isolamento dalla rete elettrica non è pertanto completo. Per ottenere un isolamento totale (ad esempio in caso di pericolo), scollegare il cordone di alimentazione. Inoltre, poichè la spina di alimentazione è utilizzata come dispositivo di sezionamento, essa deve restare facilmente raggiungibile.

7 WICHTIGE SICHERHEITSHINWEISE

- Diese Hinweise **LESEN**
- Diese Hinweise **AUFHEBEN**
- Alle Warnhinweise **BEACHTEN**
- Alle Anweisungen **BEFOLGEN**
- Dieses Gerät **NICHT** in der Nähe von Wasser verwenden
- **NUR** mit einem sauberen Tuch **REINIGEN**
- **KEINE** Lüftungsöffnungen verdecken. Gemäß den Anweisungen des Herstellers einbauen
- **Nicht in der Nähe von Wärmequellen**, wie Heizkörpern, Raumheizungen, Herden oder anderen Geräten (einschließlich Verstärkern) installieren, die Wärme erzeugen
- **Die Schutzfunktion des Schukosteckers NICHT umgehen**. Bei Steckern für die USA gibt es polarisierte Stecker, bei denen ein Leiter breiter als der andere ist; US-Stecker mit Erdung verfügen über einen dritten Schutzleiter. Bei diesen Steckerausführungen dient der breitere Leiter bzw. der Schutzleiter Ihrer Sicherheit. Wenn der mitgelieferte Stecker nicht in die Steckdose passt, einen Elektriker mit dem Austauschen der veralteten Steckdose beauftragen
- **VERHINDERN**, dass das Netzkabel gequetscht oder darauf getreten wird, insbesondere im Bereich der Stecker, Netzsteckdosen und an der Austrittsstelle vom Gerät
- **NUR das vom Hersteller angegebene Zubehör** und entsprechende Zusatzgeräte verwenden.
-  **NUR** in Verbindung mit einem vom Hersteller angegebenen oder mit dem Gerät verkauften Transportwagen, Stand, Stativ, Träger oder Tisch verwenden. Wenn ein Transportwagen verwendet wird, beim Verschieben der Transportwagen-Geräte-Einheit vorsichtig vorgehen, um Verletzungen durch Umkippen
- **Das Netzkabel dieses Geräts** während Gewittern oder bei längeren Stillstandszeiten aus der Steckdose **ABZIEHEN**.
- **Alle Reparatur- und Wartungsarbeiten** von qualifiziertem Kundendienstpersonal **DURCHFÜHREN LASSEN**. Kundendienst ist erforderlich, wenn das Gerät auf irgendwelche Weise beschädigt wurde, z.B. wenn das Netzkabel oder der Netzstecker beschädigt wurden, wenn Flüssigkeiten in das Gerät verschüttet wurden oder Fremdkörper hineinfließen, wenn das Gerät Regen oder Feuchtigkeit ausgesetzt war, nicht normal funktioniert oder fallen gelassen wurde.
- **Dieses Gerät vor Tropf- und Spritzwasser SCHÜTZEN**. **KEINE** mit Wasser gefüllten Gegenstände wie zum Beispiel Vasen auf das Gerät **STELLEN**.

	<p><i>Dieses Symbol zeigt an, dass gefährliche Spannungswerte, die ein Stromschlagrisiko darstellen, innerhalb dieses Geräts auftreten.</i></p>
---	---

	<p><i>Dieses Symbol zeigt an, dass das diesem Gerät beiliegende Handbuch wichtige Betriebs- und Wartungsanweisungen enthält.</i></p>
---	--





	Vor Änderung der Netzspannung oder Sicherungswechsel Netzkabel trennen.
	Das Gerät muss für den Betrieb geerdet werden.
	Hauptsicherung nur mit einer gleichwertigen austauschen (s. entsprechende Etikette).
	Vor Einschalten Netzspannungseinstellung am Gerät überprüfen bzw. anpassen.
	Inpoliger Netzschalter. In Notfälle oder für Wartungsarbeiten Netzkabel trennen. Der Netzstecker fungiert auch als Trennelement muss deshalb zugänglich bleiben

8 INSTRUCCIONES IMPORTANTES DE SEGURIDAD

- **LEA** estas instrucciones
- **CONSERVE** estas instrucciones
- **PRESTE ATENCION** a todas las advertencias.
- **SIGA** todas las instrucciones
- **NO** utilice este aparato cerca del agua
- **LIMPIESE ÚNICAMENTE** con un trapo seco
- **NO obstruya ninguna de las aberturas de ventilación.** Instálese según lo indicado en las instrucciones del fabricante
- **No instale el aparato cerca de fuentes de calor** tales como radiadores, registros de calefacción, estufas u otros aparatos (incluyendo amplificadores) que produzcan calor
- **NO anule la función de seguridad del enchufe polarizado** o con clavija de puesta a tierra. Un enchufe polarizado tiene dos patas, una más ancha que la otra. Un enchufe con puesta a tierra tiene dos patas y una tercera clavija con puesta a tierra. La pata más ancha o la tercera clavija se proporciona para su seguridad. Si el toma corriente no es del tipo apropiado para el enchufe, consulte a un electricista para que sustituya el toma corriente de estilo anticuado
- **PROTEJA el cable eléctrico** para evitar que personas lo pisen o estrujen, particularmente en sus enchufes, en los toma corrientes y en el punto en el cual sale del aparato
- **UTILICE únicamente los accesorios especificados por el fabricante**
-  **UTILICESE únicamente** con un carro, pedestal, escuadra o mesa del tipo especificado por el fabricante o vendido con el aparato. Si se usa un carro, el mismo debe moverse con sumo cuidado para evitar que se vuelque con el aparato
- **DESENCHUFE el aparato** durante las tormentas eléctricas, o si no va a ser utilizado por un lapso prolongado.
- **TODA reparación** debe ser llevada a cabo por técnicos calificados. El aparato requiere reparación si ha sufrido cualquier tipo de daño, incluyendo los daños al cordón o enchufe eléctrico, si se derrama líquido sobre el aparato o si caen objetos en su interior, si ha sido expuesto a la lluvia o la humedad, si no funciona de modo normal, o si se ha caído.
- **NO esponga** este aparato a chorros o salpicaduras de líquidos. NO coloque objetos llenos con líquido, tales como floreros, sobre el aparato .

	<p><i>Este símbolo indica que la unidad contiene niveles de voltaje peligrosos que representan un riesgo de choques eléctricos.</i></p>
---	---

	<p><i>Este símbolo indica que la literatura que acompaña a esta unidad contiene instrucciones importantes de funcionamiento y mantenimiento.</i></p>
---	--

	Antes de cambiar la alimentacion de voltaje o de cambiar el fusible, desconecte el cable de alimentacion.
	Para reducir el riesgo de descargas electricas, esta unidad debe ser conectada a tierra.
	Replazze el fusible con lo mismo, que corresponde a lo indicado en el panel del equipo.
	Antes de encender, controlar que la linea de alimentacion de voltaje corresponda a la indicada.
	El interruptor de alimentación es unipolar. En el caso de peligro, desconecte el cable de alimentación. Porque la clavija de conexion a red sirve por la desconection de la unidad, la clavija debe ser ubicada en proximidad de la unidad.

9 UNPACKING AND INSPECTION

Your equipment was packed carefully at the factory in a container designed to protect the unit during shipment. Nevertheless, we recommend making a careful inspection of the shipping carton and the contents for any signs of physical damage.

Damage & Claims

If damage is evident, do not discard the container or packing material. Contact your carrier immediately to file a claim for damages. Customarily, the carrier requires you, the consignee, to make all damage claims. It will be helpful to retain the shipping documents and the waybill number.

Save all packing materials! If You should ever have to ship the unit (e.g. for servicing), it is best to ship it in the original carton with its packing materials because both the carton and packing material have been carefully designed to protect the unit.

Under normal conditions no user maintenance or calibration are required. Internal links and preset controls may be set to configure the unit during installation. **Any service work required should be carried out by qualified service personnel only.**

We are able to offer further product support through our worldwide network of approved dealers and service agents.



To help us provide the most efficient service please would you keep a record of the unit serial number, and date and place of purchase to be quoted in any communication regarding this product.

The actual equipment Serial Number is indicated on the silver label stuck on the rear panel of the equipment closure.

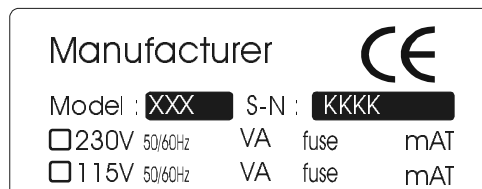

Tools And Equipment Needed

Only standard technician's tools are required to install this equipment.

10 FIRST INSTALLATION RECOMMENDATIONS

10.1 POWER SUPPLY CABLE

A power supply cable of approx. 2 m length is supplied with the device. The type of plug for the power supply depends on the country in which it is delivered. Supply cables should be laid in such a manner that one does not step or walk on them. They should not be squashed by any objects.

THIS EQUIPMENT MUST BE EARTHED.

The chassis is always connected to mains earth to ensure your safety: check your mains wiring and earthing before switching on.

10.2 AC MAINS VOLTAGE SETTING (230 V / 115 V)



BE SURE THAT THE UNIT IS SET TO THE CORRECT MAINS/LINE VOLTAGE FOR YOUR COUNTRY BEFORE PLUGGING IT INTO THE WALL OUTLET !

The actual Mains voltage is indicated on the label stuck on the equipment closure. Should the type of power at the operation location not be known, please contact your dealer or electricity company.

Manufacturer			
Model :	XXX	S-N :	KKKK
<input type="checkbox"/>	230V 50/60Hz	VA fuse	mAT
<input type="checkbox"/>	115V 50/60Hz	VA fuse	mAT

If, for some reason, the unit is to be operated at a mains input voltage which is different to that as supplied, you need to open the top cover and set properly the **voltage change-over switch** which is located inside, close to the transformer. You also need to replace the AC main fuse, according to information provided on the external label or on the Technical Specifications table at the end of this user manual.



CAUTION: TO REDUCE THE RISK OF ELECTRICAL SHOCK, ALWAYS DISCONNECT THE AC MAINS CABLE BEFORE ALTERING THE CHANGE-OVER SWITCH. NO USER SERVICEABLE PARTS INSIDE. REFER SERVICING TO QUALIFIED SERVICE PERSONNEL.

10.3 FUSE REPLACEMENT

The power supply socket has an integral fuse drawer containing the AC power fuse and a spare, both of the same value.



BEFORE REPLACING THE POWER FUSE, MAKE SURE YOU HAVE THE RIGHT TYPE OF FUSE FOR THE VOLTAGE TO BE PROTECTED. USING WRONG FUSE TYPE WILL RESULT IN INSUFFICIENT PROTECTION.

Make sure that the power is switched off and the power cable is disconnected from the equipment.

Open the fuse drawer using a small blade screwdriver.

Replace the fuse located at the inner position

Push the fuse socket back into the original position

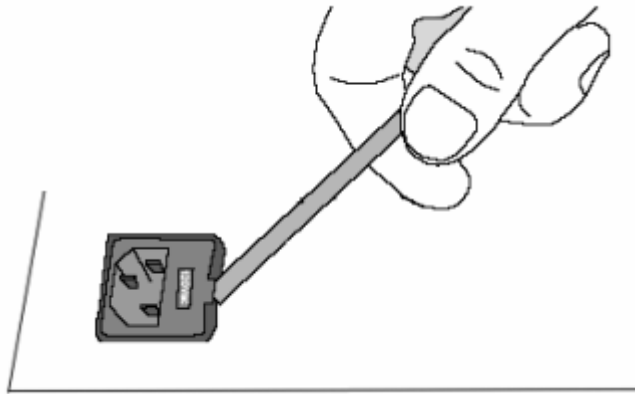

Perform the set-up under static control conditions. Static charges are likely to completely destroy one or more of the CMOS semiconductors employed in the unit. Static damage will not be covered under warranty.

Basic damage prevention consists of minimizing generation, discharging any accumulated static charge on your body and preventing that discharge from being sent to or through any electronic component.



Uninsulated dangerous voltage are inside the enclosure, voltage that may be sufficient to constitute a risk of shock.

Always disconnect to AC Mains before removing the top cover

10.4 PROTECTION AGAINST LIGHTNING



Should the device be put out of action due to being struck by lightning or excess voltage, disconnect it from the power supply without delay. Do not reconnect until the device has been checked. If in doubt contact the technical support service.

Make sure there is suitable lightning protection to protect the device.

Alternatively you should disconnect all connectors from the device during a storm or when the device is going to be unsupervised or not used for a longer period of time.

These measures will protect against damage by lightning or excess voltage.

10.5 VENTILATION

The equipment will operate as a free-standing unit without requiring any special cooling arrangement.

However, slots and openings in the product are provided for ventilation. They ensure reliable operation of the product, keeping it from overheating. These openings must not be blocked nor covered during operation.

YOU MUST LEAVE AT A MINIMUM ONE RACK UNIT OF EMPTY SPACE ABOVE THE EQUIPMENT TO ENHANCE VENTILATION AND TO GET A LONGER EQUIPMENT LIFE.

11 WIRING AND CONNECTIONS

The RDS encoder can be connected to the exciter and to the stereo generator / audio processor in two different modes: Sidechain and Loop-Through. The first one is highly recommended, as the composite / MPX is better preserved and program transmission will be not interrupted even in the event of encoder failure.

11.1 SIDECHAIN MODE (SUGGESTED)

Depending on the availability of a SYNC reference signal, the following cases are possible:

NB Using the 19 kHz clock from the stereo generator makes it much easier to phase lock the RDS signal to the pilot frequency. This is extremely helpful in eliminating intermodulation components that might exist between the pilot and RDS signal.

11.1.1 Sidechain - SYNC mode

If the stereo coder features a dedicated **TTL-level 19 kHz square wave output**, You may connect that output to the SyncIN input connector of the RDS encoder.

The encoder RDS output is then routed to the SCA (wideband) input of stereo coder, while the composite / MPX signal including RDS data is directly provided to the FM Exciter.

As the composite / MPX is not routed through the RDS encoder, its integrity is preserved and program transmission will be not interrupted even in the event of encoder failure.

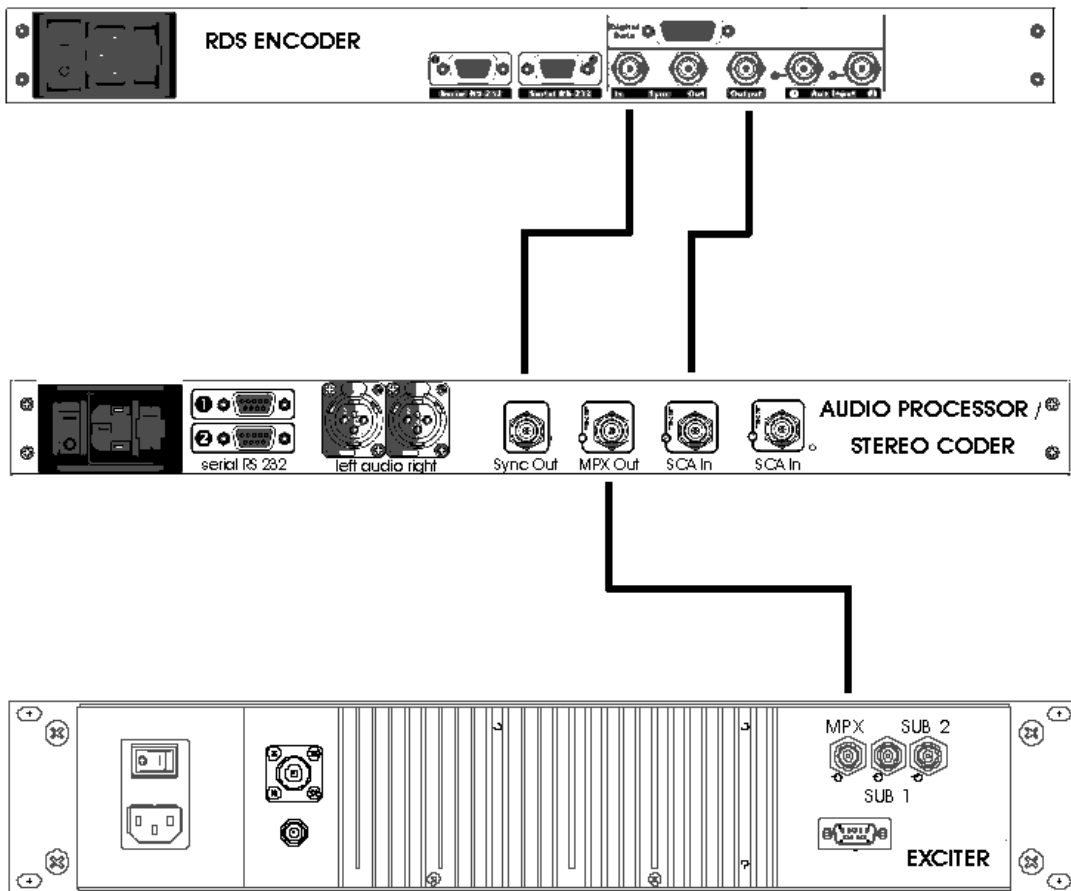

Correct synchronization to external 19 KHz TTL reference signal will cause **LOCK** LED on the front panel to light. TTL suitable levels: '0' state < 0.5 V; '1' state > 2 V . An automatic switchover to internal oscillator in case of absence or low quality of external reference signal is performed.

11.1.2 Sidechain – MPX mode

In the event the Sync reference is not available on the Stereo Coder / audio processor, the RDS encoder simply monitors the MPX output of the stereo generator to derive timing information from the 19 KHz pilot. By means of a BNC 'T' adapter, MPX output of stereo coder is thus provided to both RDS encoder and exciter.

The encoder RDS output is routed to the SCA (wideband) input of stereo coder, while the composite / MPX signal including RDS data is directly provided at the FM Exciter input.

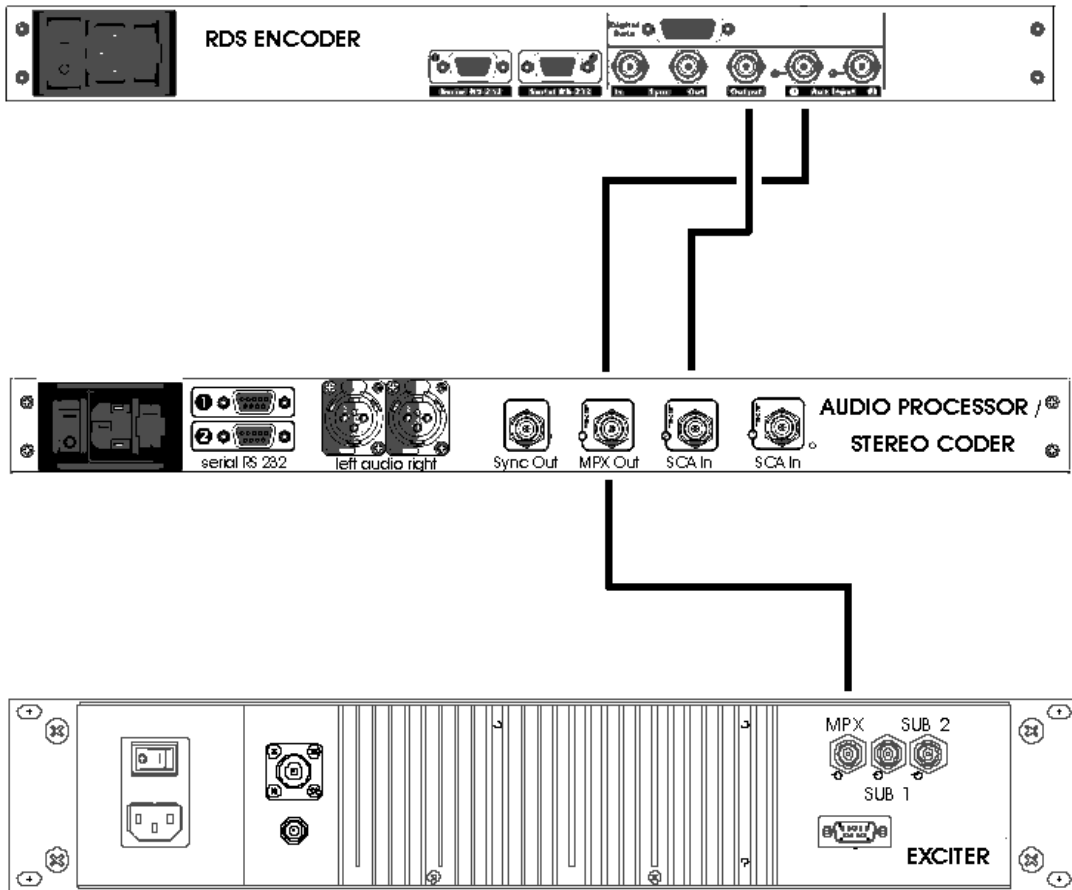

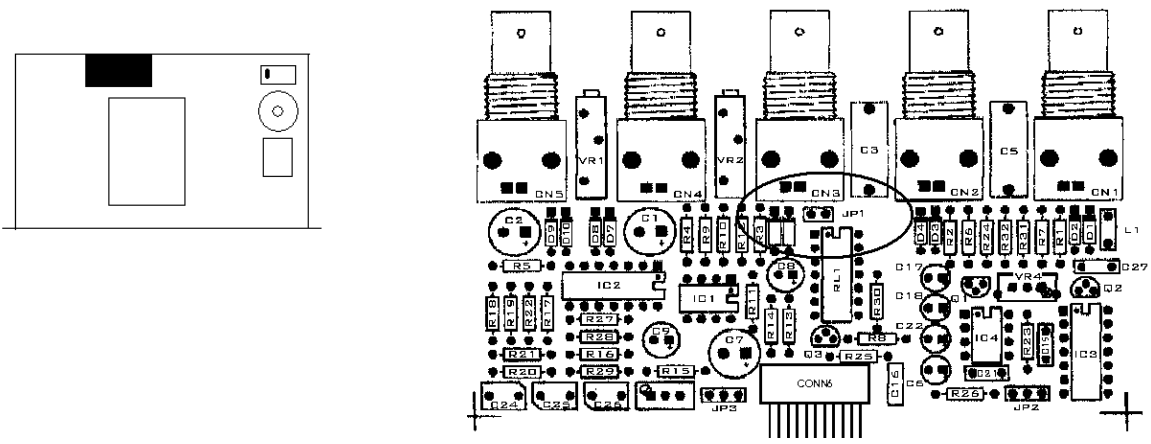

To do this, You need to **REMOVE the JP1 jumper** from the MPX board which is located inside the encoder enclosure, toward the rear panel:

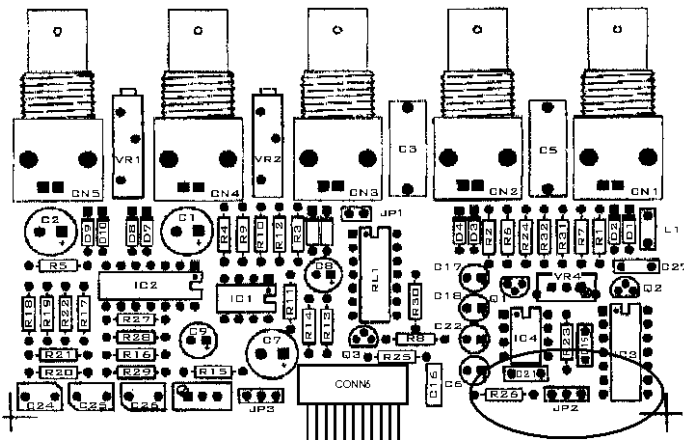

NOTE: jumper **JP2** (see picture here below) allows automatic recognition of Sync signal (TTL or derived from Analog MPX applied to the AUX1 Bnc) or it forced the coder to be synchronized only to TTL Sync. Factory preset JP2 position is 'AUTOMATIC SYNC SOURCE SELECTION' (on the right hand).



- JP2**
-  Automatic recognition of SYNC SOURCE (TTL or MPX)
 -  TTL sync source (where TTL is provided to the Sync-In input connector)



Correct synchronization to external MPX reference signal will cause LED LOCK on the front panel to light.

*MPX pilot suitable level: minimum 100 mVpp, max 1,9 Vpp
 19 kHz Sync tolerance : +/- 5Hz to lock; +/- 15 Hz to unlock
 An automatic switchover to internal oscillator in case of absence or low quality of external reference signal is performed.*

The level of the injected signal may be adjusted by means of the trimmer next to the corresponding BNC connector (no software control is provided for this purpose). This trimmer is factory preset for a gain of 0 dB.

11.2 LOOP-THROUGH MODE

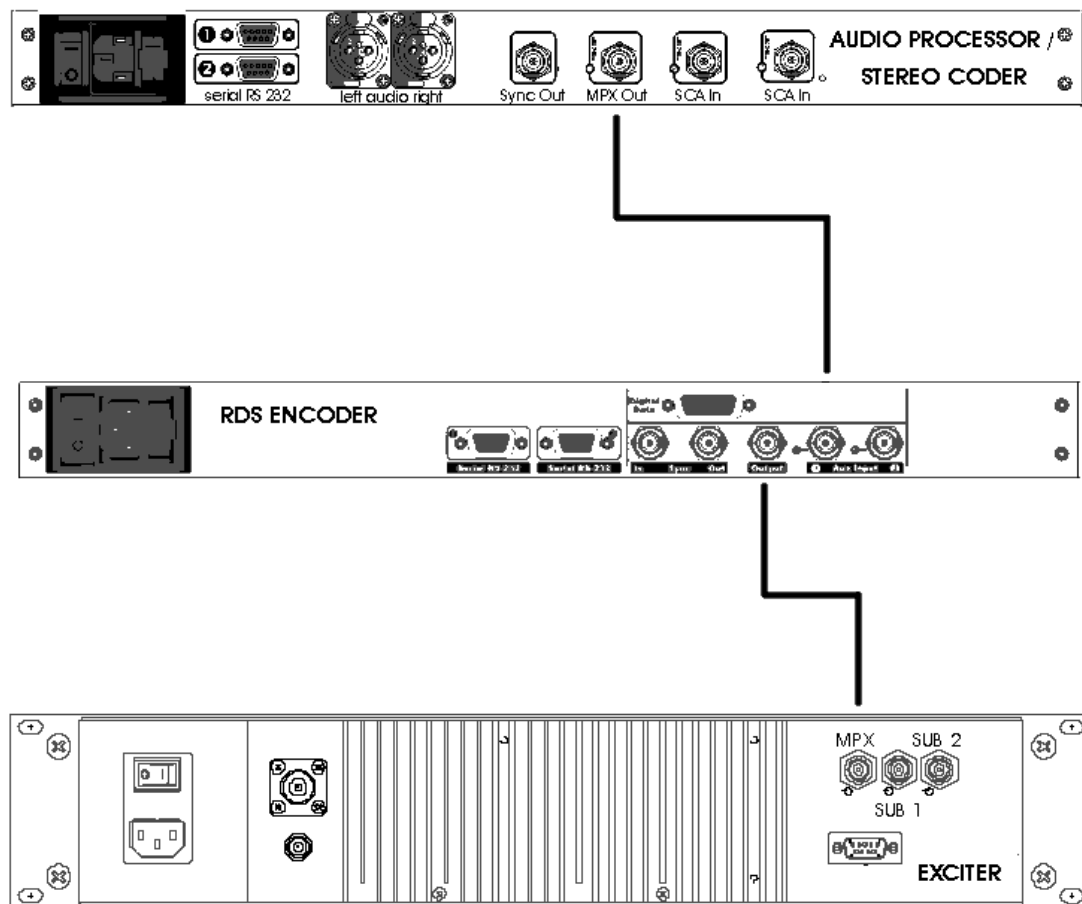

In the loop-through mode, the output of the stereo generator is directly cabled at the AUX 1 input of RDS encoder. The RDS output of the encoder will be then connected to the normal composite/Mpx input of the FM exciter.

As noticed, this configuration is NOT recommended, as the composite / MPX is passing through the encoder and program transmission will be interrupted in the event of encoder failure. This configuration doesn't need to alter the encoder factory preset. RDS subcarrier phase will be locked either to external FM stereo MPX signal. Correct synchronization will cause LOCK on the front panel to light.



Correct synchronization to external MPX reference signal will cause LED LOCK on the front panel to light.

MPX pilot suitable level: minimum 100 mVpp, max 1,9 Vpp

19 kHz Sync tolerance : +/- 5Hz to lock; +/- 15 Hz to unlock

An automatic switchover to internal oscillator in case of absence or low quality of external reference signal is performed.

The level of the injected signal may be adjusted by means of the trimmer next to the corresponding BNC connector (no software control is provided for this purpose). This trimmer is factory preset for a gain of 0 dB (unity gain).

11.3 REMOTE INTERFACE (DIGITAL DATA PORT)

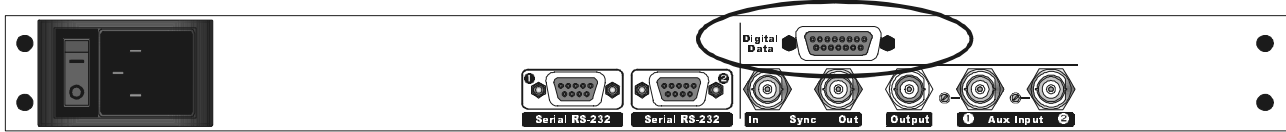

The Digital Data Port is a 15-pin female Interface which provides 4 optoinsulated “trigger” inputs. These inputs may be used to **dynamically alter the three TP, TA and M/S RDS flags and to activate the SPLIT function.**



N.B. The encoder responds on each trigger input only if the input has been enabled from the Pc control software. For TP,TA and M/S activation, refer to par. 14.1. For Split, refer to par. 14.4.

Once enabled, M/S input activation will cause M/S LED on Front Panel to light, TA activation will cause TA Led on front panel to light, etc. There are no Led associated to SPLIT function activation.

The following table displays internal connection of Digital Port and how to provide an external TTL command to (f.i.) Input # 1.

PIN	DESCRIPTION	DIRECTION	PIN	DESCRIPTION	DIRECTION
1	Cathode of photocoupler SPLIT inp.	IN	8	N.C.	/
2	Cathode of photocoupler M/S inp.	IN	9	GND	/
4	Cathode of photocoupler TP inp.	IN	10	GND	/
5	Cathode of photocoupler TA inp.	IN	11	GND	/
6	Anode of photocoupler SPLIT inp.	IN	12	GND	/
7	Anode of photocoupler M/S inp.	IN	15	+ Vcc	OUT
13	Anode of photocoupler TP inp.	IN	3	N.C.	
14	Anode of photocoupler TA inp.	IN			

Pins 9, 10, 11, 12 are linked together and provide an insulated GND connection.

A current-limited + Vdc source is available on pin 15 (+ 12 V via 1,2 K resistor).

EXAMPLE N° 1 – controlling the SPLIT from a TTL command

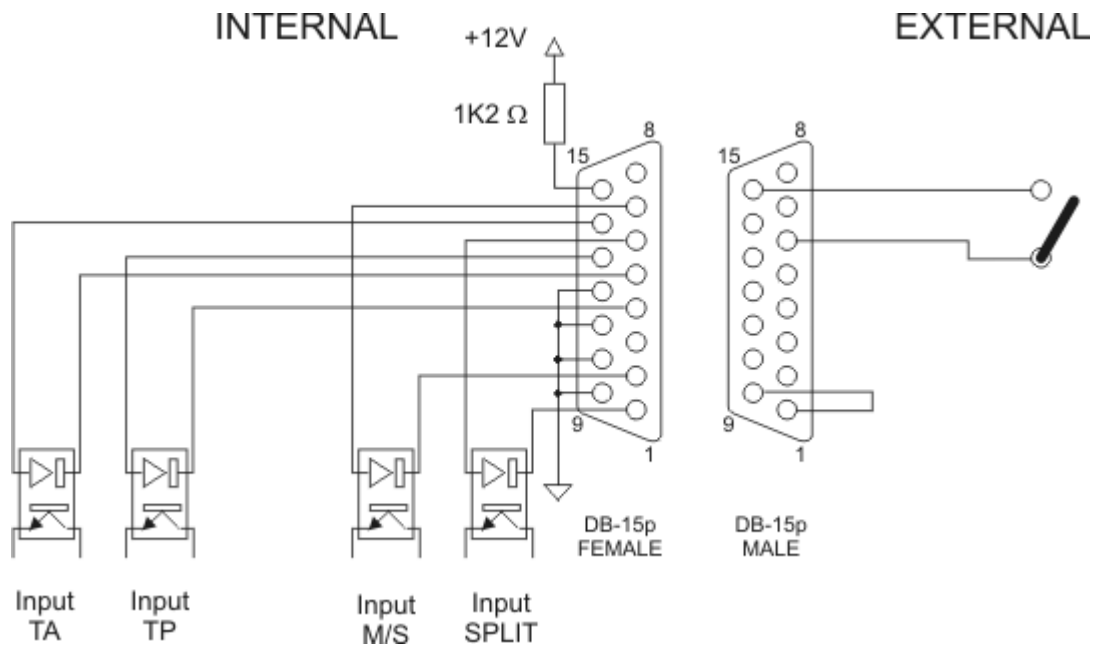

(connector internal view)

Shortcut pin 1 and 9 and shortcut pin 15 and pin 6 via an external switch.

EXAMPLE N° 2 – controlling the SPLIT from a clean contact

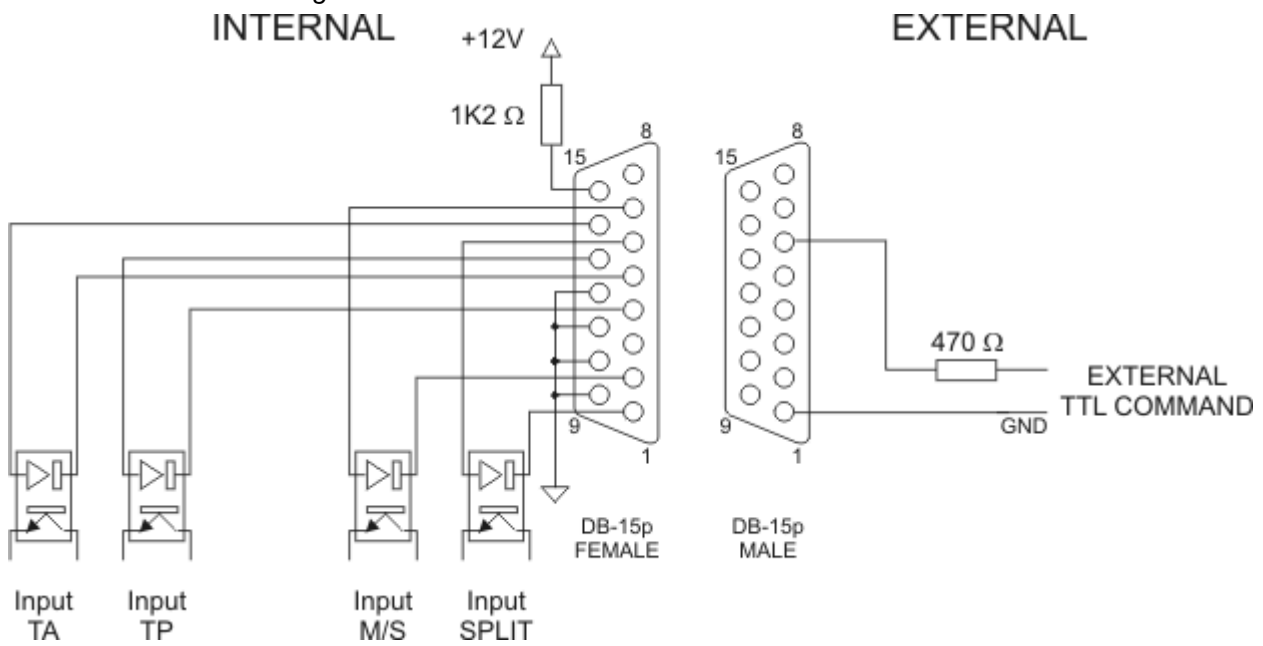

(connector internal view)

Apply an external TTL signal through a 470 Ohm carbon resistor to the SPLIT photodiode (pins 6 and 1).
Max current allowed: 10 mA. Nominal: 5 mA

11.4 THE 'SPLIT' FUNCTION

The **RDS SPLIT** mode (available **as an option** – see Chapter 2) allows the RDS encoder output to toggle between an external RDS signal applied to AUX 1 input and the RDS signal internally generated. Switching is triggered by **Input 1** on Digital Data Port (see paragraph 11.3).

With the SPLIT MODE activated (ref to the 'MAIN' WINDOWS of PC control software):

INPUT 1 on Data Port = 1 ('HIGH' STATE / POLARIZED):

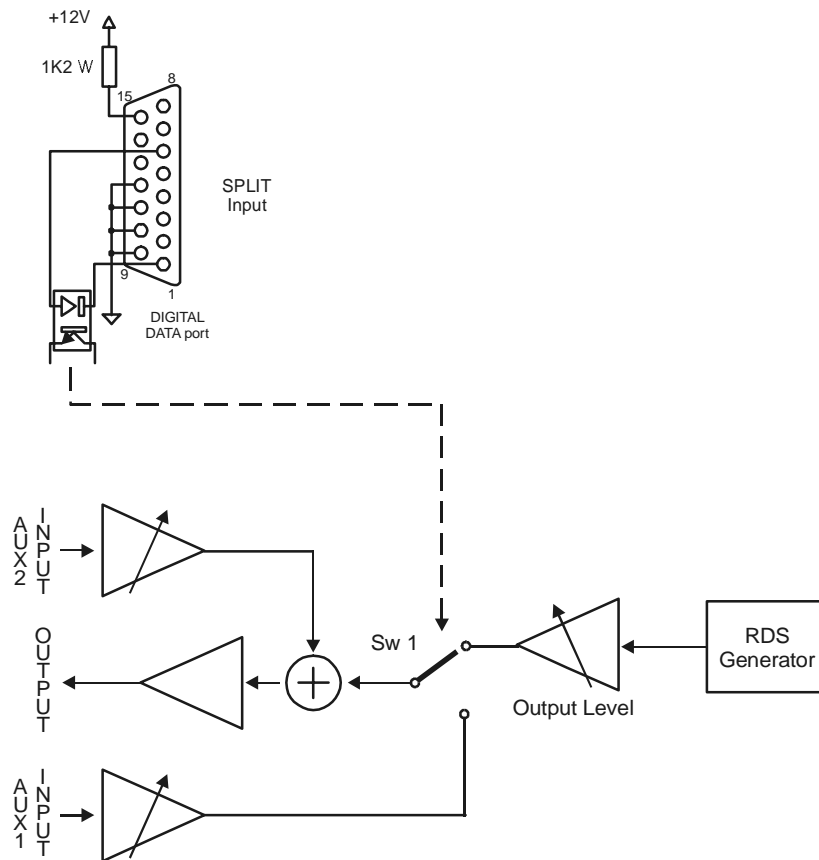

*The output will contain the RDS signal generated by the coder. The RDS signal will pass through the SW 1 switch.
Aux 2 input is always summed to the output.*

INPUT 1 on Data Port = 0 ('LOW' STATE / NOT POLARIZED):

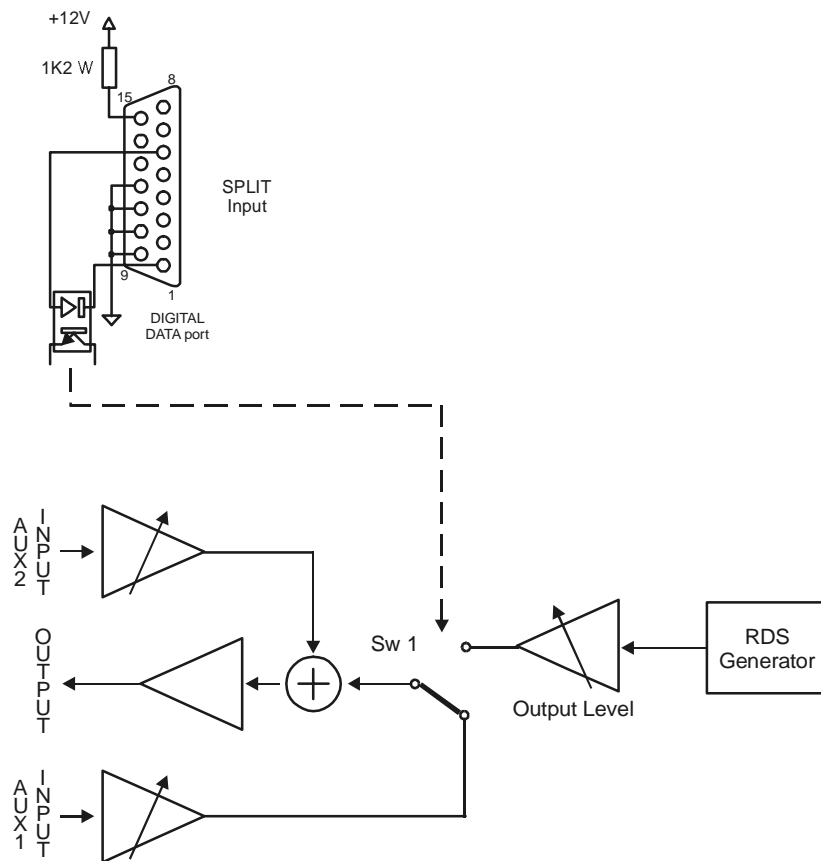

*The output will contain the external signal applied to AUX 1 connector. The internal RDS generator is disconnected.
AUX 2 input is always summed to the output.*

NOTE: with the 'SPLIT MODE' = Off (disabled), the SW 1 will permanently connect the RDS encoder to the Output.

11.5 PC INTERFACE CONNECTORS

On the rear panel of the RDS encoder are two serial ports for interfacing to IBM compatible PCs.

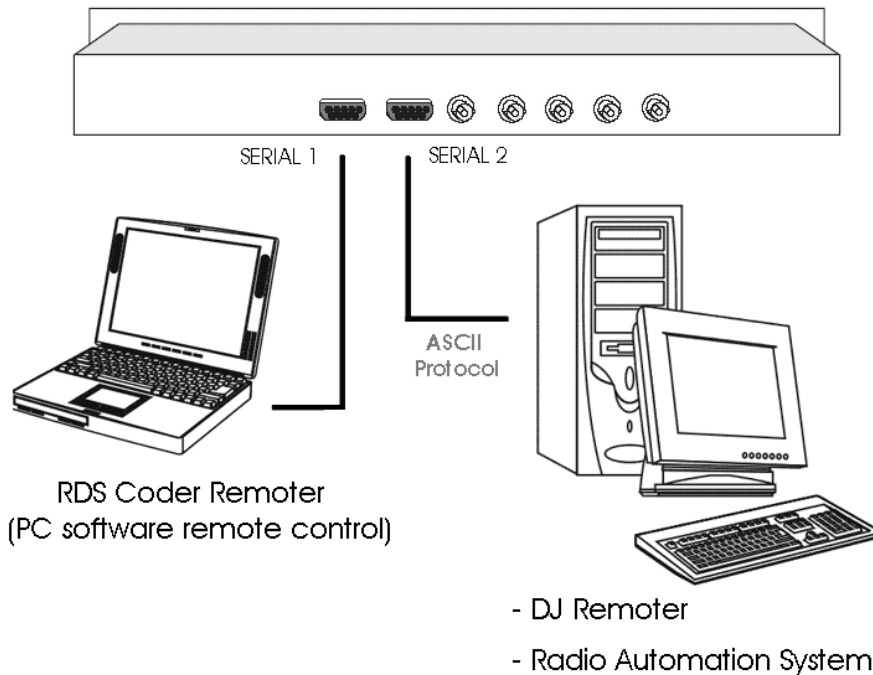

RS-232 Serial Port 1

This connector is **dedicated** only to local, bidirectional connection with an external computer running the Remote Control (Rds Coder Remoter). Connect a standard serial cable (not a null modem cable) between the RS-232 connector and a serial port connector on the computer. Typically, a DB-9 male to DB-9 female serial cable is required.

RS-232 Serial Port 2

This port is active ONLY WITH i-PS option installed and supports ASCII protocol for easy PS programming.

You need to connect to this port a computer running a simple ASCII terminal program like Hyperterminal® or a computer generating a suitable serial stream (ref to Chapter 18.6 and 19). Connect a standard serial cable (not crossed) between the RS-232 connector and one of the serial port connectors on the computer. Cable length should not exceed 20 mt.

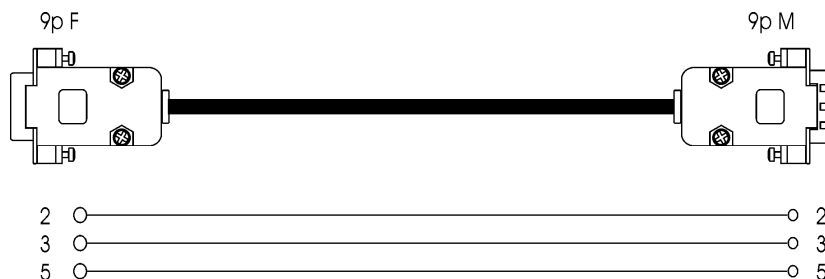

12 EQUIPMENT DESCRIPTION

12.1 FRONT PANEL LEDS

The encoder front panel contains 4 red LEDs and 3 green LEDs. There are no mechanical adjustments: all signal level, phase and data switching utilities are controlled via software. The only exception are the TP, TP and M/S switching controls described on the next pages.

POWER (red)	It displays the power supply presence. If the LED is not lit, confirm that the main power source is active, that the main switch is on and that the connector on the cord is securely mated with the plug on the back panel.
PC Link (green)	While the PC is properly connected to the encoder through the Port 1, the PC Link LED should be lit up. If this is not the case, then check the connection serial cable and the connection port selection on the PC.
ACTIVITY (green)	this LED normally flickers on when the RDS data packets are being output. It is important in that it gives you a visual indication of how active your system is, and can help ensure that it is working correctly. THE ENCODER IS OPERATING NORMALLY WHEN ACTIVITY LED IS FLASHING
LOCK (green)	It lights up when the RDS encoder has acquired lock to the 19 KHz pilot from the stereo generator or to the external TTL reference (ref to Chapter 11). If this LED is off, the encoder is not locked to external sync and it is running from its internal time base.
TP (red)	This LED lights up while Input 4 on Digital data is 'active', hence signalling TP flag is activated. (please refer to par. 11.3)
TA (red)	This LED lights up while Input 5 on Digital data is 'active', hence signalling TA flag is activated. (please refer to par. 11.3)
M/S (red)	This LED lights up while Input 2 on Digital data is 'active', hence signalling M/S flag is activated. (please refer to par. 11.3)

12.2 REAR PANEL

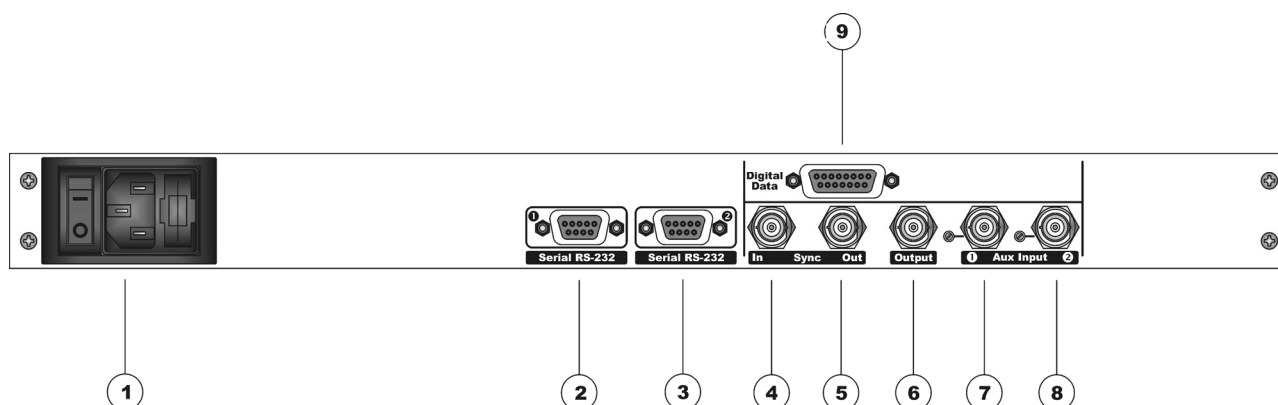

- 1 ON/OFF Switch:** main ON/OFF switch, the LED inside switches on/off accordingly. The power supply socket (use the cord provided) has a built-in fuse drawer containing the power fuse and a spare, both rated at 500 mA T for 230 VAC Main.
- 2 Serial port 1.** This port is intended for the encoder setting and programming by means of the supplied Pc control software application. It doesn't support ASCII commands protocol (ref to Chapter 11.5). Supported Baud Rate: 19200.
- 3 Serial port 2** This port is intended for PS and RT programming via ASCII commands protocol (i-PS option required).
- 4 Sync In:** BNC female connector. It enables RDS synchronisation by separate 19kHz clock (TTL input). allows synchronization of RDS signal to an external TTL reference signal (5 Vpp).
- 5** Not connected.
- 6** Accordingly to the encoder configuration, the **Output BNC** connector (50 OHM impedance) will include the composite / MPX program signal with the RDS subcarrier added or will provide the RDS subcarrier only (with or without signals injected on Aux 2 mixed into).
- 7 AUX 1 Input:** BNC female connector. It serves also as a synchronism input: a multiplex or pilot signal should be connected here to synchronise the RDS carrier.
- 8 AUX 2 input.** It allow the SCA injection from external coders. The resultant signal is available on the Output connector.
- 9 Digital Data Port:** SubD 15-pin female Interface. It provides 4 optoinsulated "trigger" inputs (for M/S, TP, TA service enabling and for SPLIT mode enabling) – Ref to 11.3.

13 THE PC SOFTWARE REMOTE CONTROL

13.1 INTRODUCTION

The encoder comes with a powerful and reliable software running on Windows 95, 98, NT, ME, 2000, XP platforms and specially designed for equipment programming and control.

Through a normal PC, the software allows the remote control of the RDS level, phase and source synchronism as well as the statement and the management of the messages and the RDS services.

The basic software screen always displays, in real time, PS and RT content currently on air, allowing a full and immediate monitor of RDS broadcasting, even when a FM tuner is not available.

The optional i-PS module further boosts new PS management features: it eliminates every PS programming constraint and leaves the maximum freedom in terms of message length, save / recalling facilities and message editing masks. Any text can be entered and broadcast 'on-the-fly' both as a full PS sequence or in a scrolling mode.

Furthermore, featuring a true ASCII communication protocol, i-PS software module enables the coder to be easily and quickly interfaced to any hard disk automation systems, for song and artist identification on PS fields and much more...!

NOTE: the Pc remote software requires a two-way serial connection (with «return channel») via the encoder's **Serial Port 1** (ref to Chapter 11.5).

Serial cable (not crossed type) should be not more than 20 meters long

13.2 CONTROL SOFTWARE INSTALLATION

A) Using standard Windows procedures, access the PC REMOTE SOFTWARE folder and run the SETUP.EXE file under the Microsoft Windows '95, '98, ME, 2000, NT and XP operating system.

B) The install program installs Pc remote Control application onto the computer's hard disk. The installation screen will also suggest a destination directory for the software. If You have a reason to specify another directory for installation, use the Browse button or type an alternative path.

C) Click to Install and Next to complete installation. This takes only a few seconds. When the software is successfully installed, *Finish* message will appear at the bottom of the installing box. Click Close to close the installation screen.

D) Standard Windows procedures can be used to create a shortcut to the program on the desktop.

it is advised to completely uninstall possible existing older versions before running the new one.

To uninstall the existing Pc control software, proceed as follows:

- enter the Windows -Control Panel-
- click on the -Install Applications- icon
- choose the item of current version from the list and select it
- click on the -Add/Remove- button
- confirm deletion of all proposed files
- run the new Remote Control program starting from the -Programs- Menu of the Start button on Yr Pc



13.3 SOFTWARE SETUP

Run the program. If it is unable to immediately establish a bidirectional connection with the encoder, (as indicated by the display message '**Target not connected**'), a screen such as the following will appear:



First of all, it is necessary to indicate which computer serial port is dedicated to the communication with the encoder (COM 1, 2, 3, 4, 5, 6, 7 or 8).

Once a port is assigned, the software will automatically start attempting to connect to the encoder in bidirectional mode. Specifically:

-  *If the serial port is NOT physically present on the computer, the message '**Selected Serial port not available**' will appear*
-  *If the serial port selected is physically present on the computer, but is not connected to the encoder (f.i. it is connected to a different equipment), the message '**Target not connected**' will appear*
-  *If the serial port selected on the computer is present and is connected to the encoder's port 1, the program will display the message '**Connected to Target**'. At the same time, the **Lock** LED on the encoder front panel will light.*

NOTE: the program will automatically attempt the connection each time you run the software.

- If selected, the option '*Always On Top*' will always keep the control program window in the foreground of the desktop.

Click '**Synchronize**' to update the encoder time to the current PC clock time.

-  *make sure Yr current Pc time is correct before updating the encoder time !*

Click EXIT to quit the SETUP panel.

13.4 LOAD AND SAVE FUNCTIONS



SAVING THE CURRENT SETTINGS

Any operative configuration of the current Panel may be saved at any time.

To do so, simply click 'Save' button and indicate the name with which to save the configuration (for example, the operator's name).

LOADING AN EXISTING CONFIGURATION

Click the Load key: it will open a window showing all the available configuration files of current panel. These files have multiple extensions, accordingly to the selected panel.

Select the desired file and click 'open'.

13.5 SEND PANEL / CLOSE PANEL BUTTONS

Once you have finished altering one or more fields, click *Send* to load parameter changes into the encoder or click *Close Panel* to quit: a pop-up message will ask You for leaving with or without sending changes to Target.

14 THE MAIN CONTROL PANEL

The Main Panel contains all the settings related to the RDS signal that is currently being transmitted. It groups the basic RDS settings (level, phase, synchronization source - internal clock or external TTL / MPX signal) and the RDS service configuration.

Alternative Frequencies list is also available.

14.1 RDS SERVICES - QUICK SUMMARY

PI The PI code consists of four hexadecimal digits (see 'Code' field). The first identifies the country where the program is transmitted, the second digit identifies the type of broadcaster based on coverage area. Finally, the 'Ref' window must contain a number between 1 and 255 (normally assigned by the authorities). Select the most appropriate item from the corresponding window: the program will automatically provide the corresponding hexadecimal digit. If the complete code is already known, type it directly into the Code field.

PTY this pull-down menu allows you to set the type of broadcast programming (i.e., News, Sports, Rock, Pop, etc.). It is used to enable the receiver to automatically search for the desired type of program.

DI this pull-down menu allows you to set the kind of modulation (Stereo, Mono, etc). Stereo modulation is assigned to **STEREO, STATIC PTY**, while mono is **MONO, STATIC PTY**

M/S It is a status signal (flag) indicating whether the broadcast is *music* or *speech*, to adjust the balance or volume settings appropriately on specially designed receivers. To permanently enable or disable this function, select SPEECH or MUSIC from the pull-down menu. It is also possible to tie the MS switch to a proper **external command** supplied via **Digital Data** interface (ref to par. 11.3). To do this, select **EXT INP** from the menu. **

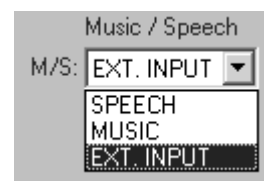

TP It is a status signal (Flag) identifying those broadcasters who periodically schedule traffic-related reports or programs. To permanently enable or disable this function, select ENABLED or DISABLED from the pull-down menu. It is also possible to tie the TP switch to a proper **external command** supplied via **Digital Data** interface (ref to par. 11.3). To do this, select **EXT INP**. **

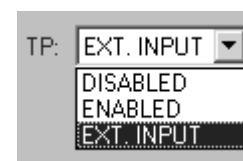

TA **Traffic announcement** identification is an on/off switching signal to indicate when a traffic announcement is on air. To permanently enable or disable this function, select ENABLED or DISABLED from the pull-down menu. It is also possible to tie the TA switch to a proper **external command** supplied via **Digital Data** interface (ref to par. 11.3). To do this, select **EXT INP.** **

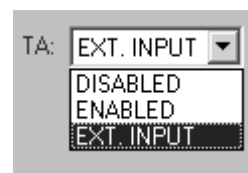

** while enabled, the corresponding LED on the front panel will light.

14.2 PS CHARACTER TABLES

The **PS character table** control allows to select one of the following ISO tables:

ISO 8859-1(Latin 1)
 ISO 8859-2(Latin 2)
 ISO 8859-5(Cyrillic)
 ISO 8859-7(Greek)
 ISO 8859-9(Turkish)
 ISO 8859-10(Nordic languages)

with reference to CENELEC tables E.1,E.2,E.3.



Attention must be drawn to the fact that low cost receivers may be able to display only a limited character set.

14.3 RDS SYNCHRONISM SOURCE

This selection switches between external or internal Sync reference. External reference signal may be a TTL signal (injected into the 'Sync In' input) or a MPX signal (injected into Aux 1 input) – see par. 11.



Even if EXTERNAL SYNC SOURCE is selected, the encoder will perform an automatic switchover to internal oscillator in case of absence or low quality of external reference signal

14.4 ENABLING THE 'SPLIT' MODE

To enable the output **SPLIT** mode (available **as an option** – see Chapter 2 and Chapter 11.4) select the 'Split Mode' box on the Main RDS Panel.

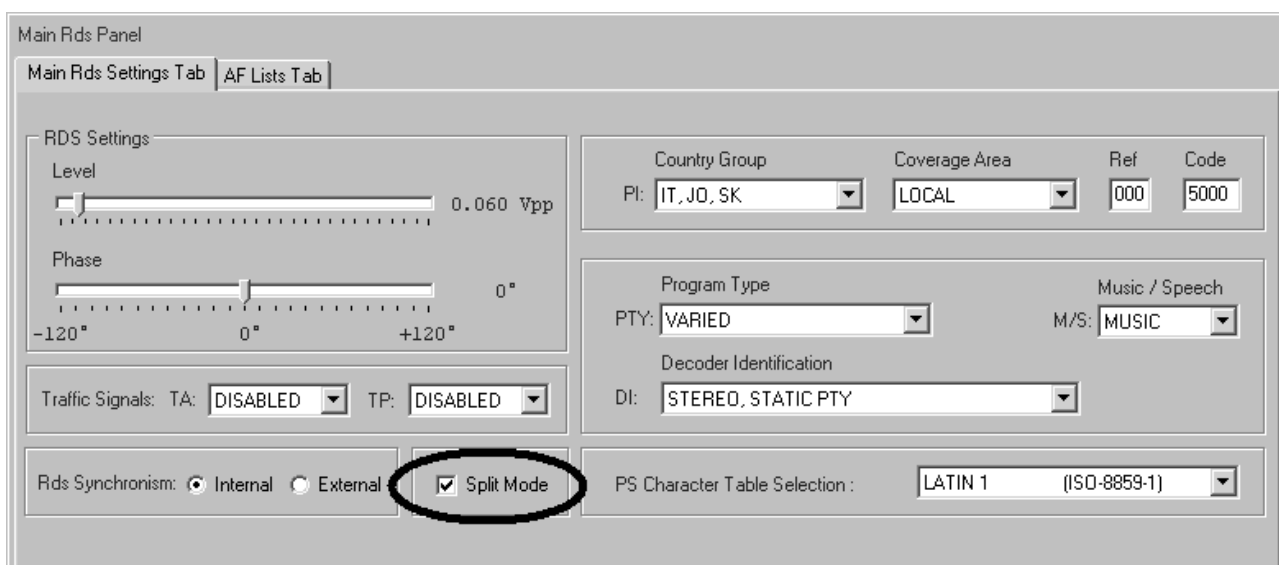

15 ALTERNATIVE FREQUENCIES LIST

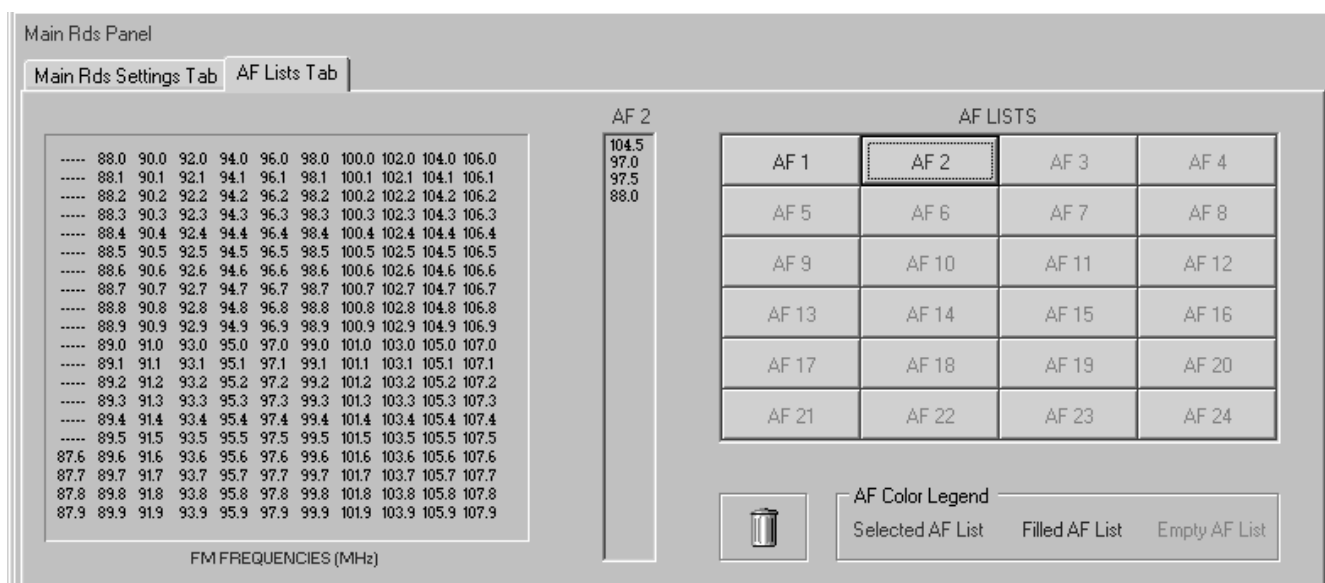

The list(s) of **alternative frequencies** give information on the various transmitters broadcasting the same programme in the same or adjacent reception areas, and enable receivers equipped with a memory to store the list(s), to reduce the time for switching to another transmitter. This facility is particularly useful in the case of car and portable radios.

The alternative frequencies (AF) list can be transmitted following two methods: A Method and B Method (see next page).

In both methods the alternative frequencies lists must contain only the frequencies of the adjacent transmitters and repeaters with overlapped transmitting areas.

To **compile the AF lists** use the following procedure:

- Choose one of the 24 lists (from AF1 to AF8)
- Select the AF from the available frequencies in the left window and drag & drop it into the AF list
- To remove a frequency from the list follow the procedure drag & drop to move to 'recycle bin' or cancel them by pressing on the 'Cancel' button.

A second loading procedure is provided:

- Click the label of the AF List to be filled (f.i., click AF2 label): it will turn red
- Double click the frequencies listed on the left window: selected frequencies will be automatically loaded into the highlighted list.

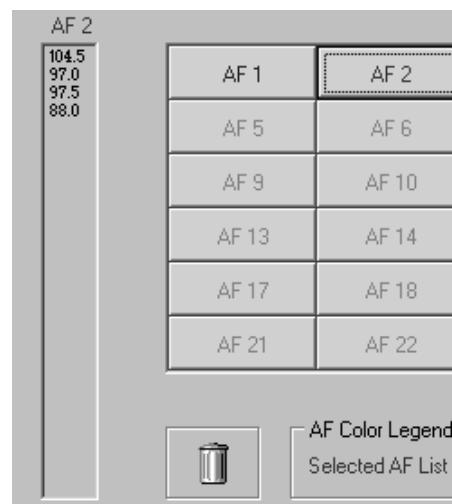

Lists containing at least one AF are shown in blu color.

15.1 AF METHODS A AND B

There are two ways to transmit lists of alternative frequencies: Method A and Method B.

In both cases the lists should include only those frequencies for the nearest transmitters and repeaters (with overlapping coverage areas).

Generally speaking, Method A is used when the list contains no more than 25 frequencies, and Method B when the list is longer (for a maximum of 24 lists).

Method B is recommended when splitting areas or when different programs are broadcast.

NOTE: use of encoding method A or B is not explicitly assigned by a dedicated signal to the receiver, as the latter is capable of identifying which method is used by analyzing the transmitted data structure (whether or not they are organized in pairs).

METHOD A

Compile the AF1 list assigning the tuning frequency (i.e. the frequency carrying the list of alternative frequencies) in the first position, and then continue in strictly increasing order with the alternative frequencies transmitting exactly the same program.

We recommend recording the alternative frequencies (those of adjacent transmitters and repeaters with overlapping coverage areas) on each transmitter, being careful that the first position indicates the frequency carrying the list of alternative frequencies.

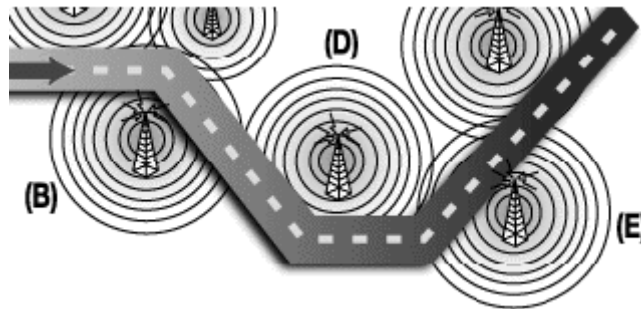

For example, in the situation shown in the figure three transmitters (B, D, E) intersect only in two coverage areas: between B and D, and between D and E. The following lists should be loaded in each transmitter:

<p>Tx B lists (tuning frequency: f Tx B)</p>	<p>AF1</p>	<p>AF2</p>	<p>Note that the frequency of transmitter C is not included in the list, since the latter's coverage area does not overlap with that of transmitter A</p>	
	<p>f Tx B f Tx D</p>	<p>f Tx D f Tx B</p>		
<p>Tx D lists (tuning frequency: f Tx D)</p>	<p>AF1</p>	<p>AF2</p>	<p>Coverage area D partially overlaps that of both transmitters B and E, and thus it is recommended to load the lists for both adjacent transmitters. Be careful to list all frequencies above the tuning frequency in ascending order.</p>	
	<p>f Tx D</p>	<p>f Tx B</p>		<p>f Tx E</p>
	<p>f Tx B f Tx E</p>	<p>f Tx D</p>		<p>f Tx D</p>
<p>Tx E lists (tuning frequency: f Tx E)</p>	<p>AF1</p>	<p>AF2</p>	<p>Note that the frequency of transmitter B has not been included in the list, since its coverage area does not overlap with that of transmitter E.</p>	
	<p>f Tx E f Tx D</p>	<p>f Tx D f Tx E</p>		

METHOD B

As mentioned earlier, Method B is used with high numbers of alternative frequencies and/or when the transmitter also has frequencies that broadcast different radio program at various times of day (splitting, local programming, etc.).

In the latter instance, the mobile receiver should check whether the AF is broadcasting the same content before selecting another frequency.

Each list begins with the *tuning* frequency (for which the list is valid) and then contains up to 12 **pairs of frequencies** in sequence, each containing the *tuning* frequency and an alternate. If there are more than 12 possible alternative frequencies, the list continues in other lists in the same manner.

The order of the frequencies in each pair follow the rules below:

- If the order is increasing, the alternative frequency broadcasts the same programming as the *tuning* frequency.
- If the order is decreasing, the two frequencies have different programming.

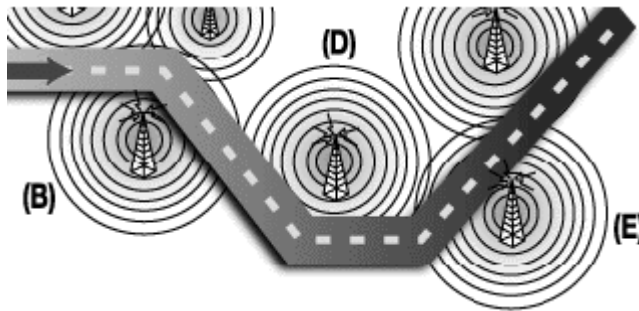

Returning to the example of transmitters B, D and E in the previous paragraph (in which the coverage areas of D and E do not overlap), two more lists will be assigned to transmitter B, sorted according to the above criteria to take into account any different programming by some of the AFs.

Tx B (tuning frequency: f Tx B)	AF1	AF2	Notice that the tuning frequency f Tx B is repeated twice in list 1: in the first position, then paired with f Tx D. Tx B broadcasts the same program as D if $f \text{ Tx B} < f \text{ Tx D}$, and different programs if $f \text{ Tx B} > f \text{ Tx D}$.
	f Tx B	f Tx D	
	f Tx B	f Tx D	
	f Tx D	f Tx B	

The AF lists for the other transmitters are compiled according to the same criteria, alternating the frequency pairs. NOTE: if the same tuning frequency is used by more than one transmitter within the same network, the corresponding AF lists must not be consecutive (for instance AF 1 and AF 2). Lists for different tuning frequencies must be placed between them.

16 RADIOTEXT AND RT SCHEDULER



Once You have selected the Radio Text panel, You can be enter up to 8 Radio Text messages, each one having up to 64 characters (spaces included). This refers to text transmissions, primarily addressed to consumer home receivers, which would be equipped with suitable display facilities. A simple and intuitive scheduler panel allows You to provide your instructions to the encoder's timer, telling it which RT message you want transmit, at what time and for how long.

Radiotext Panel	Start (hr:min)	Stop (hr:min)	Enable/Disable
RT 1: RADIO BBC INTERNATIONAL	00 : 00	23 : 59	<input checked="" type="checkbox"/> Enable
RT 2: MORNING PROGRAM... FOR A NEW DAY	06 : 00	08 : 30	<input checked="" type="checkbox"/> Enable
RT 3: MIDDAY ENTERTAINMENT	12 : 00	14 : 00	<input checked="" type="checkbox"/> Enable
RT 4: EASY LISTENING.. IN THE AFTERNOON	15 : 00	18 : 00	<input checked="" type="checkbox"/> Enable
RT 5: CALL US: TEL + 44 051 856974 · FAX + 44 051 859241	20 : 00	21 : 30	<input checked="" type="checkbox"/> Enable
RT 6: RADIOTEXT 05	00 : 00	00 : 00	<input type="checkbox"/> Enable
RT 7: RADIOTEXT 06	00 : 00	00 : 00	<input type="checkbox"/> Enable
RT 8: RADIOTEXT 07	00 : 00	00 : 00	<input type="checkbox"/> Enable

RT A/B Flag

Close Panel Load Panel **Save Panel** Send Panel

To enter RadioTexts, type the new message (64 char max) into each field. To delete a text or modify it, use regular Windows text editing tools.

An 'on-air' time band can be easily associated to each message. Start and end times of each message are completely user-definable in 1 minute step.

You can activate or deactivate any single event at any time using the *Enable/Disable* option provided for each event.

 **The first RT message (RT 1) is enabled by default and thus broadcast all day long. If no RT broadcast is wanted, leave blank the first RT field (RT 1) and make sure there are no further messages enabled in the Scheduler table.**

16.1 RT A/B FLAG

The A/B flag is an important part of proper radiotext transmission. This flag is used to signal the receiver when a new text message is transmitted. When the receiver detects a change in the A/B flag state, the radiotext receiver buffer will be cleared, preventing the possibility of a mixture of old and new text messages being displayed on the receiver.

In conclusion, the A/B flag should be enabled when multiple RT messages are scheduled, while it can be disabled in the event of a fixed RT broadcasting.

16.2 RT SCHEDULING PRIORITY

When two or more **RT overlap**, the priority is automatically assigned to the event with the **highest order number** (e.g., RT 4 has higher priority than RT 2).

EXAMPLE

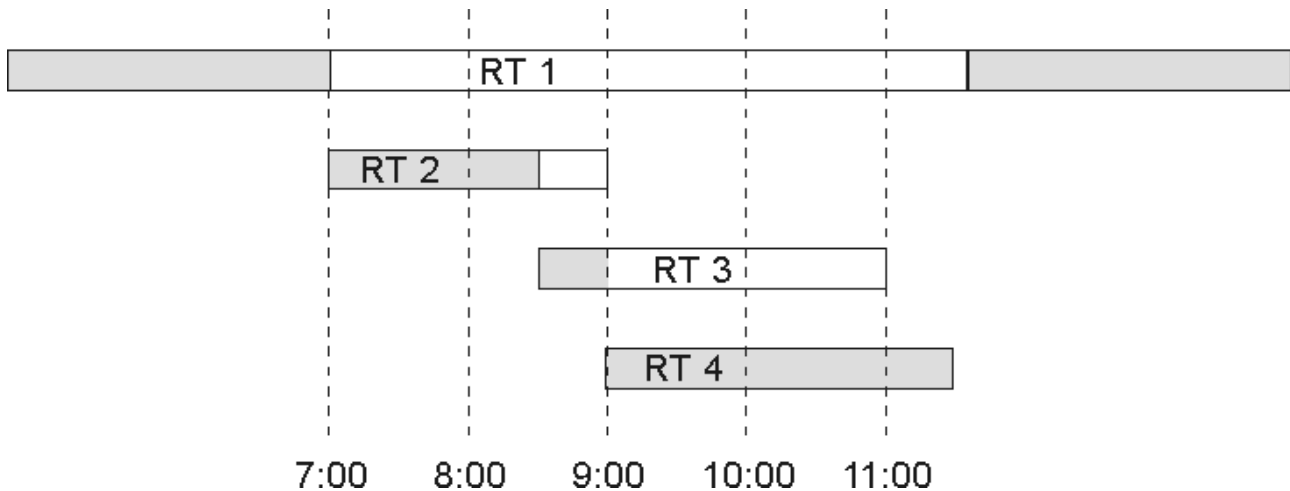

The picture here above shows a possible daily programming for 4 RT.

In this case, only RT 4 is broadcast as programmed (from 9:00 to 11:30). RT 3 is broadcast from 8:30 to 9:00, RT 2 from 7:00 to 8:30 and **RT 1 will be broadcast before 7 and after 11.30, as in the other time slots it is completely 'hidden' by other RTs**.

Dolphin will investigate every minute for a new scheduled RT and will activate it. A new scheduled RT may be therefore broadcast within 1 minute.

NOTE:

- Change between 12- and 24-hour format is not available
- The changes to a schedule are immediately saved and implemented. Your scheduling work goes into effect (i.e. 'on air') in max 1 minute.
- Please pay attention to time coherence of start and stop time of each scheduled RT! Error messages will guide You while programming events..

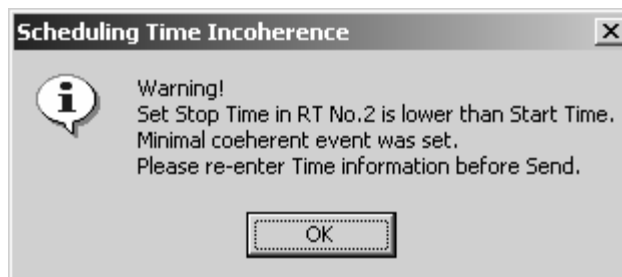

17 PS AND PS SCHEDULER

The PS panel allows to transmit single PS messages, PS sequences as well as PS Scrolling messages.

PS messages are grouped in pages, each one allowing the transmission in sequence of maximum 20 PS, or a transmission in scrolling mode of a 32 characters string.
In both modalities the refresh (step) speed is fully user-definable.

An intuitive scheduler tool allows to set a **beginning** and an **end** time of transmission for each page, except for the **first page which is always active**.

A dedicated summary table – always displayed at the right window side - allows an easy round-up of the active pages and of the on air schedule. Each page can be saved on Pc or recalled from file.

Program Service Panel

PS Page 1 | PS Page 2 | PS Page 3 | PS Page 4 | PS Page 5 | PS Page 6 | PS Page 7 | PS Page 8

PS Sequence

PS 1: BBC ONE PS 2: PS_G1_02 PS 3: PS_G1_03 PS 4: PS_G1_04
 PS 5: PS_G1_05 PS 6: PS_G1_06 PS 7: PS_G1_07 PS 8: PS_G1_08
 PS 9: PS_G1_09 PS 10: PS_G1_10 PS 11: PS_G1_11 PS 12: PS_G1_12
 PS 13: PS_G1_13 PS 14: PS_G1_14 PS 15: PS_G1_15 PS 16: PS_G1_16
 PS 17: PS_G1_17 PS 18: PS_G1_18 PS 19: PS_G1_19 PS 20: PS_G1_20

Refresh Speed: 3 Sec Sequence from PS 1 to: PS 1

PS Scrolling Edit: PROGRAM SERVICE SCROLLING 0 Speed: 1.5 s

Enable Start (hr:min): 00 : 00 Stop (hr:min): 23 : 59 Load Page Save Page Send Page

Close Panel

Program Service Scheduler Summary Table

Page #	Start	Stop	Enabled
1	00:00	23:59	Yes
2	00:00	00:00	No
3	00:00	00:00	No
4	00:00	00:00	No
5	03:00	05:00	Yes
6	06:00	07:29	Yes
7	00:00	00:00	No
8	07:30	09:00	Yes



WARNING: if the PS is constantly changed (as in the PS Scrolling mode), it is possible that some receivers will display a mixture of old and new PS message on the same display. In some cases, no PS will be displayed at all. This may occur as message byte group order is not univocally recommended by the CENELEC RDS standard and strictly depends on the coder/decoder physical implementation. Neither the RDS encoder nor the car receiver are faulty. In case of PS Scrolling selection, we therefore suggest to choose low display speeds. **PS scrolling and PS Sequence mode are against the broadcast regulations of most countries: refer to appropriate 'governing body' for further information.**

The encoder's manufacturer can not be held responsible for uncorrect PS use!

17.1 PS SEQUENCES

Each page of the Program Service Panel allows You to easily create and broadcast sequences composed by up to 20 PS Names.

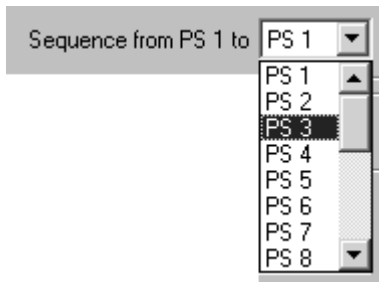

To create a sequence, You have just to select the last item of it, as the first item is set by default (PS 1).

 **To transmit a FIXED PS, set Sequence from PS 1 to PS 1**

EXAMPLE 1

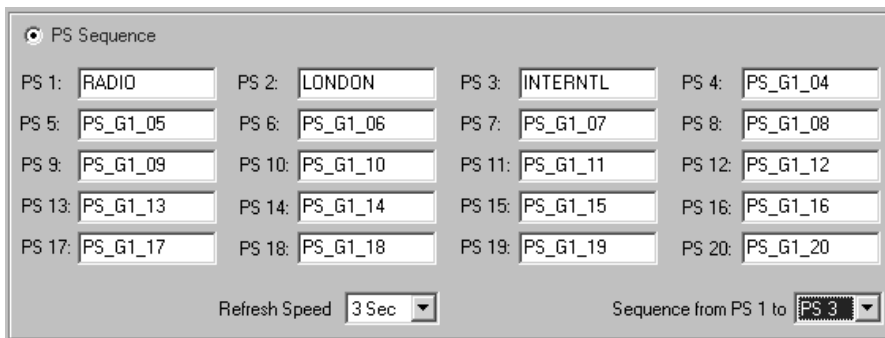

accordingly to the settings as in the picture here closed the PS sequence will be: **RADIO / LONDON / INTERNTL / RADIO / LONDON / INTERNTL / etc.**

EXAMPLE 2

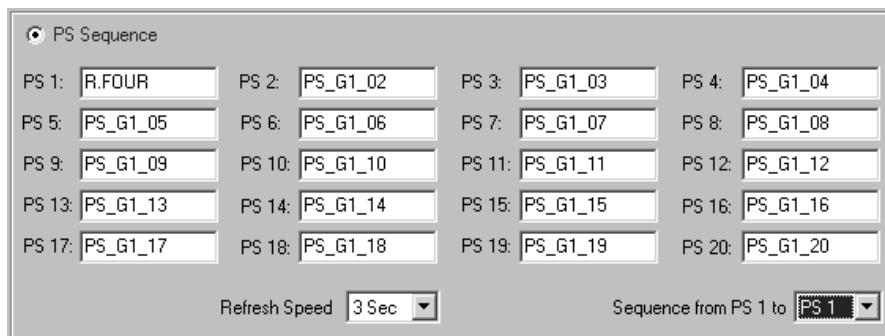

Accordingly to the settings in the picture here eabove, the encoder will transmit 1 fixed PS (R.FOUR), displayed at all time.

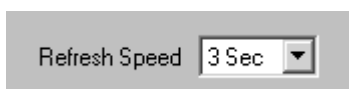

By means of the Refresh Speed menu is possible to set a precise time duration for each PS (i.e. number of seconds, from 2 to 10). It is the time, each PS will last on the receiver display.

NOTE: the time needed for a receiver to properly receive and display a message is dependent upon numbers of characters in the message, the reception conditions at the receiver, the overall number of groups carried out by RDS signal and software implementation of PS feature.It is therefore advisable a minimum rate factor of around 3 seconds.

17.2 PS SCROLLING



Alternatively to PS Sequences or fixed PS message, each Page allows You to enter one PS message which will scroll on the receiver display. It means, text is moved right to left across the display one character at a time at the rate set by the user (SPEED, from 1.0 to 5.0 seconds, 0.5 sec step).

Max length: 32 characters.

17.3 PS PAGE SCHEDULER

An 'on-air' time band can be easily associated to each page. Start and end times of each page are completely user-definable in 1 minute step.

You can activate or deactivate any single event at any time using the *Enable/Disable* option provided for each event.



The first page is enabled by default and thus it is broadcast all day long. When two or more PS overlap, the priority is automatically assigned to the event with the highest order number (e.g., PS 4 has higher priority than PS 2).

EXAMPLE

In the event the Scheduler resembles as following:

Program Service Scheduler Summary Table			
Page #	Start	Stop	Enabled
1	00:00	23:59	Yes
2	12:30	14:15	Yes
3	14:00	16:30	Yes
4	16:30	18:30	Yes
5	10:00	15:00	No
6	15:00	17:00	No
7	19:00	23:00	No
8	23:01	23:59	No

Figure 1

the PS PAGE sequence on air will be:

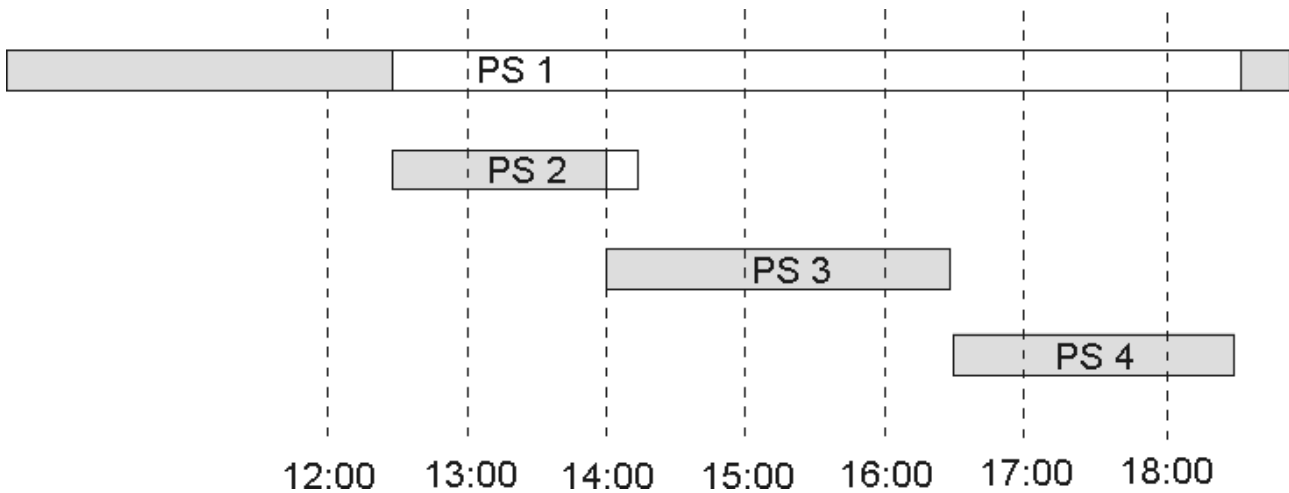

The picture here above shows the overlapping over the time of the 4 PS pages scheduled accordingly to Figure 1.

- PS Page 1 will be hidden by PS2, PS3 and PS4 as the latter ones have higher priority.
- The latter 15 minutes of PS2 are hidden by PS3
- PS 4 and PS 3 only are broadcast as scheduled.
- PS from 5 to 8 are left disabled.



it is highly recommended to configure Page 1 as the 'default' page (i.e. the page carrying the default PS message).

18 THE I-PS OPTION

18.1 WHAT IS THE I-PS OPTION

The **i-PS (Instantaneous PS)** is a software module available as an option, which allows to compose and air any kind of PS message in an easy and immediate way!

Traffic announcements, football match scores, interactive games with the audience, dedications, telephone numbers, urgent reports: any text can be entered into dedicated fields, and 'on-the-fly' aired both as a PS sequence and in scrolling mode. Furthermore, the i-PS software module enables the encoder to be easily and quickly interfaced to any hard disk automation systems, for song and artist identification on PS fields and much more...!

18.2 HOW TO GET IT

The i-PS option could be pre-installed in the factory if notified when ordering the unit or it can be installed at the customer' premise after receiving it.

In the latter case, the i-PS software must be activated with a **proper Activation Key**, uniquely determined by your unit firmware's serial number. Please proceed as follows:

1) Note down the unit's firmware Serial Number

The Serial Number of the firmware currently installed on Yr encoder appears on the SETTING page, once the Target is connected to the Pc. It is a 13 digit code.

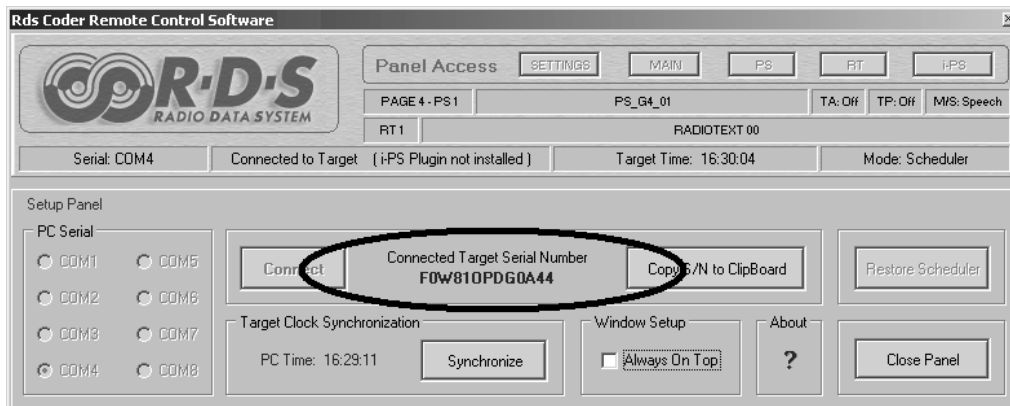

2) submit (via fax or email) the S/N to the manufacturer.

3) The manufacturer will return a special Activation Software Key. Please follow instructions on the Chapter 'Firmware Upgrade' for further steps.

With the i-PS option activated, the i-PS button on the main screen will turn active



18.3 THE DYNAMIC PS PANEL - INTRO

Once You have clicked the i-PS button, a dynamic panel will be shown, each one containing 8 PS pages. Each page of the Program Service Panel allows You to easily create and broadcast sequences composed by up to 48 PS Names or to transmit up to 32 PS strings in scrolling mode. In both modalities the refresh (step) speed is fully user-definable.

NOTE: No scheduling capabilities are provided within i-PS pages.



On the contrary of the PS Page (see previous Chapter), the i-PS pages allow you to send PS 'on the fly' and with the highest priority in respect of other scheduled PS events. Just click the 'Send Page' button displayed at the right bottom corner of each page.

**i-PS mode will engage as soon as You send a page to the encoder.
i-PS mode is disengaged as soon as You:**

- Close the i-PS panel
- Close the program
- Click 'RESTORE SCHEDULER' button in the 'Settings' panel.
- Turn off / on the encoder



Once you have finished loading a new page or just altering one or more PS, click *Send* to enable changes on air.

It is possible to save or recall any page using the Load and Save keys displayed at the right bottom corner of each page:

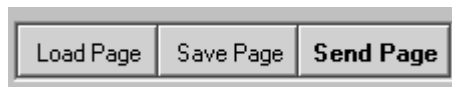

LOADING AN EXISTING PAGE

- Click the Load key: it will open a window showing all the available configuration files.
- Select the desired file and click 'open'.
- Once you are certain that the correct page has been chosen, you may possible load that page into the encoder via the 'Send Page' button.

NOTE: a proper message will remind You to save changes to current page(s) before leaving i-PS panel.

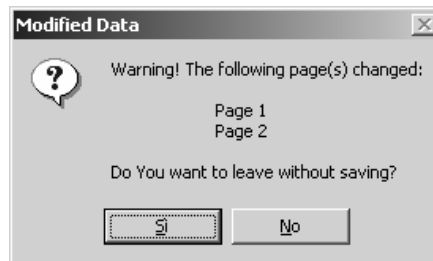

SAVING THE CURRENT PAGE

Any i-PS page may be saved at any time. To do so, simply press the 'Save' button and indicate the name with which to save the page (for example, the operator's name). You need to save each one of the 8 pages separately.

NOTE: the software will automatically prompt the configuration present the last time the i-PS panel was closed.

18.4 'ON THE FLY' PS SEQUENCES

Each i-PS page contains a 48 PS grid (allowing to compose up to 48 PS sequences) plus a PS Scrolling menu.

The aspect of the grid - in terms of field grouping - is determined by the option specified on the Options dialog box:

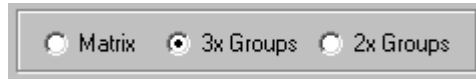

The **MATRIX** option is the 'classical' one:

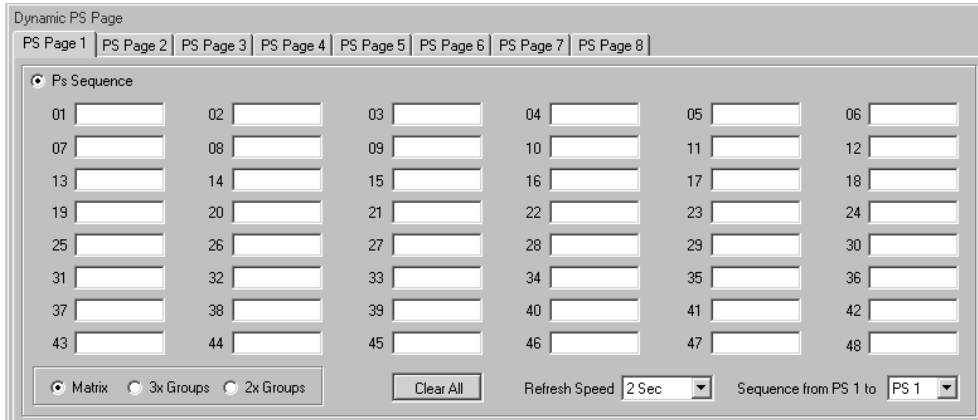

The **3X GROUPS** option provides a special PS field layout, where fields are grouped by three. That grid layout allows, f.i., an easy and convenient way to broadcast sport match scores:

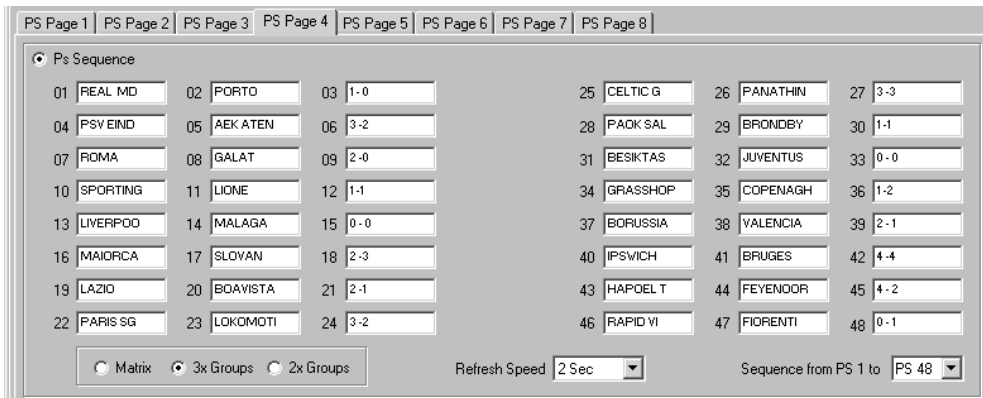

The **2X GROUPS** option provides a special PS field layout, where fields are grouped by two:

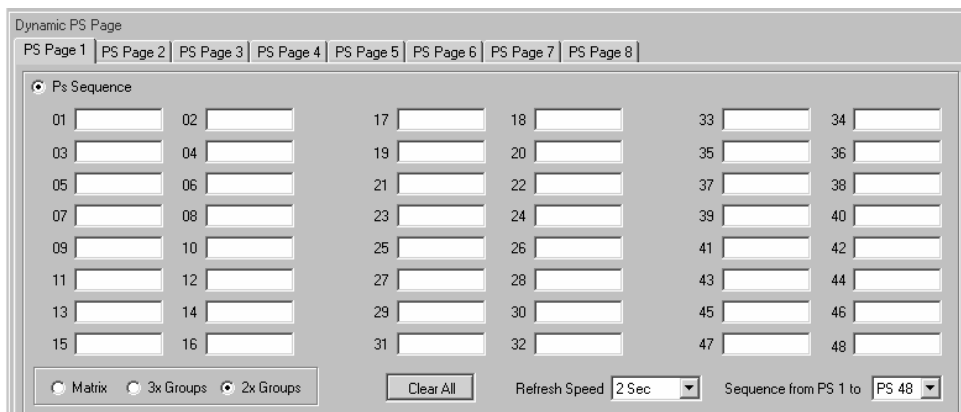

18.5 PS SCROLLING

For each of the i-PS pages it is possible to edit up to 32 messages of 32 characters each, which are automatically saved can be and which can be instantly recalled.

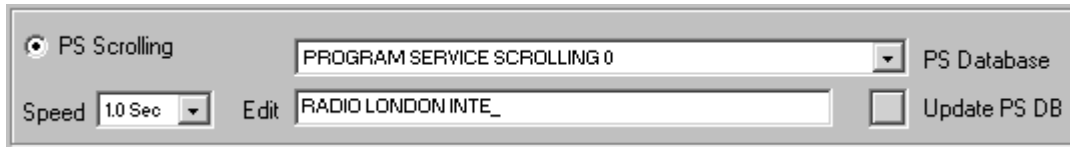

PS Scrolling PROGRAM SERVICE SCROLLING 0 PS Database
Speed 1.0 Sec Edit RADIO LONDON INTE_ Update PS DB

To edit a PS message to be transmitted in scrolling mode, choose the PS Scrolling option and enter the text (up to 32 characters length) into the Edit field. After entering it, click Update PS DB (DataBase) button: the new string will be automatically added to the PS Scrolling database and it will be also displayed in the upper row, meaning it is ready for transmission.

Alternatively, You can search through the Database for an existing string and recall it quickly by opening the PS Database:

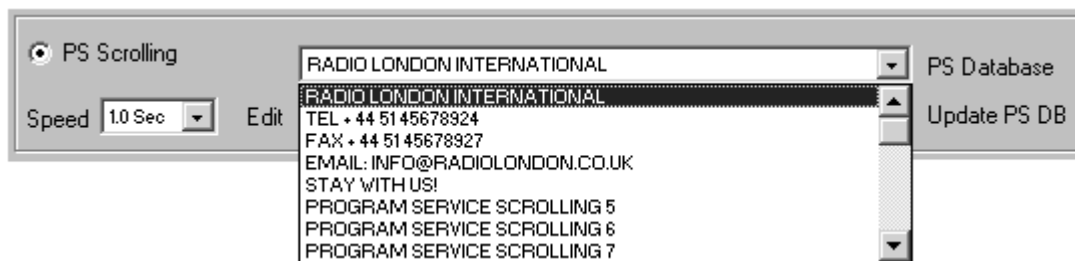

PS Scrolling RADIO LONDON INTERNATIONAL PS Database
Speed 1.0 Sec Edit Update PS DB
RADIO LONDON INTERNATIONAL
TEL + 44 51 45678924
FAX + 44 51 45678927
EMAIL: INFO@RADIOLONDON.CO.UK
STAY WITH US!
PROGRAM SERVICE SCROLLING 5
PROGRAM SERVICE SCROLLING 6
PROGRAM SERVICE SCROLLING 7

18.6 THE DJ REMOTER

The i-PS option includes also a useful tool for the DJ or the announcers to be installed, for instance, on the On Air Pc.

It is a simplified interface for the sequenced transmission of 4 PS, or of a text in scrolling mode, which have priority over the normal (scheduled) PS programming.

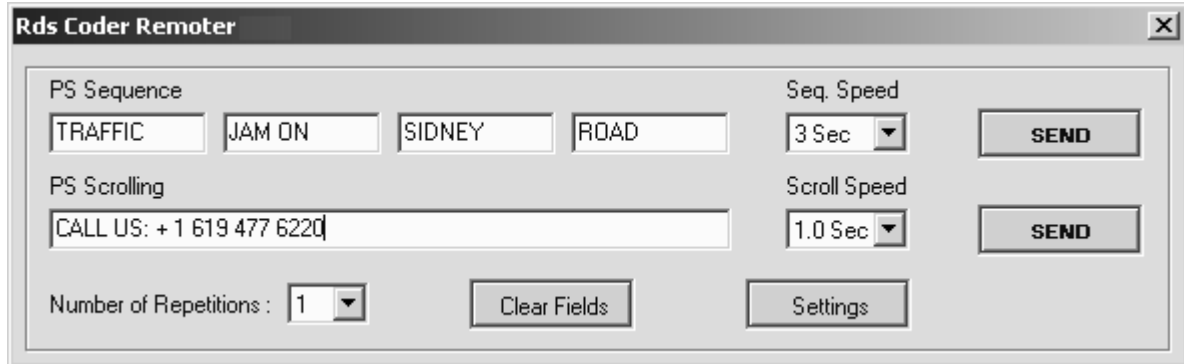

HOW TO INSTALL IT

The Dj Remoter doesn't require any special installation procedure: just follow instructions provided on Chapter 13.2 for the PC control software. Dj Remoter will run from START / PROGRAMS path.



HOW TO CONNECT TO THE ENCODER

Connect the PC running the DJ Remoter software to the RDS encoder via the encoder's SERIAL PORT 2 (please refer to 11.5). DJ Remoter uses ASCII protocol.



HOW TO CONFIGURE THE DJ REMOTER SOFTWARE

Click the **Settings** button: some hidden menu will appear, allowing to select the Pc serial port and the PS character alphabet.

With the '*Hide on Tray at Startup*' option selected, the software's icon will be shown in the small area at one end of the Task Bar (the bar that contains the Start Button) near the clock and the program will not automatically launch.



To open it (or to close it) click right the icon:



HOT TO USE THE SOFTWARE

For PS sequences and PS Scrolling, refer to par. 17. **The '*number of repetitions*' menu allows You the number of times the entered message will circulate before the encoder resumes its regular PS transmission, as scheduled in the PS page of the Pc control software (see par. 17.3)**

19 ASCII-Hex Protocol Definition (Parser ASCII - rel 1.1)

With the i-PS option installed, PS messages to be transmitted can be supplied to the encoder via a simple serial protocol in ASCII format, easily implemented, for instance, on hard disk automation systems. That allows, for example, to broadcast by RDS the title and the author name of the song currently on air ...

19.1 BAUD RATE AND SERIAL PORT SETTINGS

Speed: 19200 Baud, data bits: 8, stop bits: 1, hardware flow control: *none*, parity: *none*.

19.2 COMMAND AND STRING DELIMITERS

Each command (or each command line) must be followed either by a carriage return (0x0D) or by the dot character (0x2E).

19.3 STRING DELIMITERS

Start *Minor* character (0x3C) followed by *inverted commas* character (0x22)

Stop *inverted commas* character (0x22) followed by *major* character (0x3E)

Example: <"this is a valid ps scrolling string">

19.4 SUB-FIELD (PARAMETER) DELIMITERS

Each sub-field composing a string is separated by a starting 'equal' character (0x3D) and by commas (0x2C).

Example: ps_seq = 020 , <"PS NUM 1"> , <"PS NUM 2"> , <"PS NUM 3">

19.5 UNVALID CHARACTERS

The following characters are not permitted:

- not-ASCII characters (hexadecimal value greater than 0x7F)
- (NOTE: some variants could be allowed, accordingly to character / language table in use)
- format control characters (hexadecimal values lower than 0x0D)

19.6 TIMEOUTS

- max time allowed for entering a single character: 20 seconds
- max time allowed for entering a single command line: 120 seconds

If using HyperTerminal® tool, enable Echo typed characters locally into Properties / Settings / AsciiSetup, so that characters received from the Pc are echoed back. Remaining parameters are set by default.

19.7 COMMAND SET

NB: commands can be entered in either upper or lower case. The PS is a RDS parameter consisting of no more than 8 characters that will be displayed by the RDS receivers. Normally the PS represents the name of the broadcasting radio station. For example:

BBC ONE **Ok**
RAI MF1 **Ok**
bluwave **Ok**
antennatwo **Bad (too much characters)**

HELP	Displays a menu with a summary of valid commands
HELP_PS_SEQ	Displays PS_SEQ command syntax
HELP_PS_SCROLL	Displays PS_SCROLL command syntax
DYN_MODE_ON	Enables and refresh the Dynamic programming mode NOTE: <i>dynamic state is not continuously sustained. The encoder will automatically resume the Scheduler mode unless DYN_MODE_ON command is provided every 10 minutes. Radio automation system should therefore refresh that command every 10 minutes. At the power on, the encoder starts by default from Scheduler mode.</i>
DYN_MODE_OFF	Disables the Dynamic programming mode
PS_SEQ	It defines the PS dynamic sequence. Command format will be: PS_SEQ= xxx , <"AAAAAAAA"> , ... , <"AAAAAAAA"> Where: xxx: sequence time (in tenth of seconds) - {020,030,040,050,060,070,080,090,100}*** <"AAAAAAAA">: PS content (max lenght = 8 characters) For example: Ps_Seq = 030 , <" RADIO "> , <"PROGRAM "> , <"SERVICE "> If valid, the response " OK. VALID PSN_SEQ_COMMAND" will be returned. NOTE: <i>void PS will be not accepted. In the event of PS shorter than 8 characters, filling spaces will be automatically added. In the event of PS larger than 8 characters, exceeding characters will be automatically cut out.</i> *** NOTE sequence times are approximated. If more precise times are required, following (mean) times can be taken into account (parameter value within brackets): 0870ms (010), 1950ms (020), 3060ms (030), 3950ms (040), 5250ms (050), 6080ms (060), 6990ms (070), 7980ms (080), 8980ms (090), 9750ms (100).
PS_SCROLL	It defines the PS SCROLLING dynamic sequence. Command format will be: PS_SCROLL = xxx , <"BBB.....BBB"> , Where: xxx: scrolling time (in tenth of seconds) {005,010,015,020,025,030,035,040,045,050} *** <"BBB...BBB">: scrolling text (max lenght = 32 characters) For example: Ps_Scroll = 010 , <"THIS IS A SCROLLING TEXT"> If valid, the response "OK. VALID PSN_SCROLL_COMMAND" will be returned. NOTE: <i>In the event of PS SCROLL shorter than 32 characters, filling spaces will be automatically added. In the event of PS larger than 32 characters, exceeding characters will be automatically cut out.</i> *** NOTE scrolling times are approximated. If more precise times are required, the

	following (mean) times can be taken into account (parameter value within brackets): 0800ms (005), 1100ms (010), 1580ms (015), 1970ms (020), 2370ms (025), 2760ms (030), 3530ms (035), 3980ms (040), 4450ms (045), 4850ms (050).
--	---

19.8 STRING SEQUENCE

To broadcast a string in either scrolling or sequence mode:

- 1) activate Dynamic mode (DYN_MODE_ON)
- 2) send PS_SCROLL / PS_SEQ
- 3) refresh Dynamic mode every 10 minutes (i.e. re-send DYN_MODE_ON command)
- 4) deactivate Dynamic mode (DYN_MODE_OFF)

Example:

```
DYN_MODE_ON
Ps_Seq = 020 , <" THIS">, <"IS">, <"THE">, <" BEST">, <"RADIO">, <"STATION">
PS_SCROLL = 030 , <"STATION ONE - EASY LISTENING">,
DYN_MODE_OFF
```

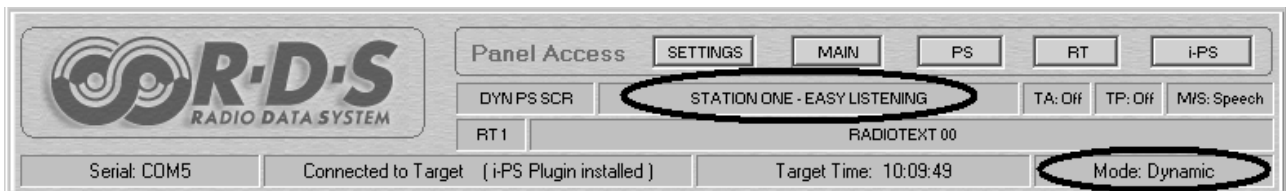

19.9 ERROR SUMMARY

ERROR 1	Unknown Command
ERROR 2	PS Sequence Speed Format Error
ERROR 3	Empty PS Message
ERROR 4	Unexpected End of Command
ERROR 5	Syntax Error
ERROR 6	PS Sequence Speed Out Of Range
ERROR 7	PS Scrolling Speed Format Error
ERROR 8	PS Scrolling Speed Out Of Range
ERROR 9	Command Sequence Timeout
ERROR 10	Dynamic Mode Refresh Timeout
ERROR 11	i-PS PlugIn not installed

20 HINTS AND TIPS ABOUT DYNAMIC PS MODE

When programming PS durations in Dynamic mode, two 'gold' rules should be taken into account. They are related to the 'physics' of RDS channels and are completely independent from RDS encoder architecture.

- 1) Although the RDS encoder support PS Scrolling step time ranging from 0,8 seconds to 4.8 and PS Sequence times from around 0,9 seconds, in order to fit PS displaying capabilities of the most part of RDS receivers on the market, **PS Scrolling step duration should be not less than 1 second** and PS Sequence should change with a rate of 2 seconds minimum.
For best results, times not less than 4 or 5 seconds should therefore be used.
- 2) Drivers CAN NOT look at messages displayed on their radio cars longer than a few seconds. LONG PS SEQUENCES are therefore not only be distracting car driver but they are simply.... not read!
Furthermore, they affect the quality of RDS broadcasting overall, as the Radio Station default Name refresh could be not frequent enough.
PS scrolling lenght has been thus intentionally limited to 32 characters, as that lenght is largely suitable for a large set of meaningful messages.
Message synthesis... means quality in Dynamic RDS broadcasting!

21 FIRMWARE UPGRADE

The RDS encoder comes from the factory with the most recent firmware installed just prior to shipping. When required, the firmware can be updated with the latest available version.

Firmware upgrade can be performed on all Windows 9x, ME, 2000, XP, NT platforms.



After an initialization of the device (firmware upgrade), all user presets and adjustments are erased and/or overwritten by the new factory setup! Please make a note of Yr current, customized software presets before proceeding with the firmware upgrade.



When upgrading the firmware, do not forget to install the new associated software version of PC remote control. There is a direct correspondence between the firmware and software versions.
For example, the rel. 1.3 of Pc software requires the firmware version 1.3 installed on the unit and viceversa. As general rule, software version X.Y.Z runs with firmware version X.Y.

In order to upgrade the firmware on the unit, please follow this procedure:

NOTE It is also possible to **install i-PS plug-in** after purchasing. See 'HOW TO UPGRADE..' section here below.

1) MAKING THE UNIT READY FOR UPGRADING

- A) shut off the unit
- B) remove the equipment cover and the guarantee labels
- C) set the jumper JP1 of the Mother board to the **LEFT (external)** position. Jumper is located near to the large battery, on the **left hand** (see highlighted jumper in the picture)

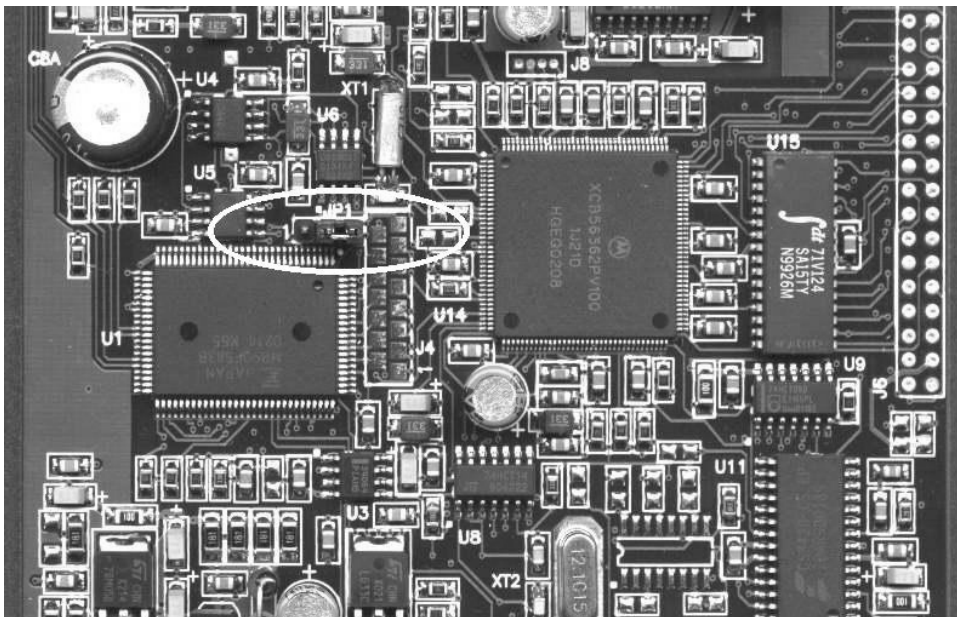

FIRMWARE
PROGRAMMING



NORMAL
OPERATION

- D) Connect the encoder's **SERIAL** port **1** to that of the Host PC. Please insert (or remove) the serial connector only with the unit turned off. A regular (i.e. not crossed) cable is required
- E) Turn the unit on
- F) **make sure LOCK Led on the front panel blinks**

2) PC OPERATION

- G) Close all opened applications on the PC
- H) Access the **Fw UpGrades** folder
- I) Double click the **file associated to the desired upgrade**

- **Basic_Upgrade** if Yr encoder doesn't feature the i-Ps option, yet.
- **i-PS_Upgrade** if Yr encoder already features the i-Ps option

The following screen will be displayed:

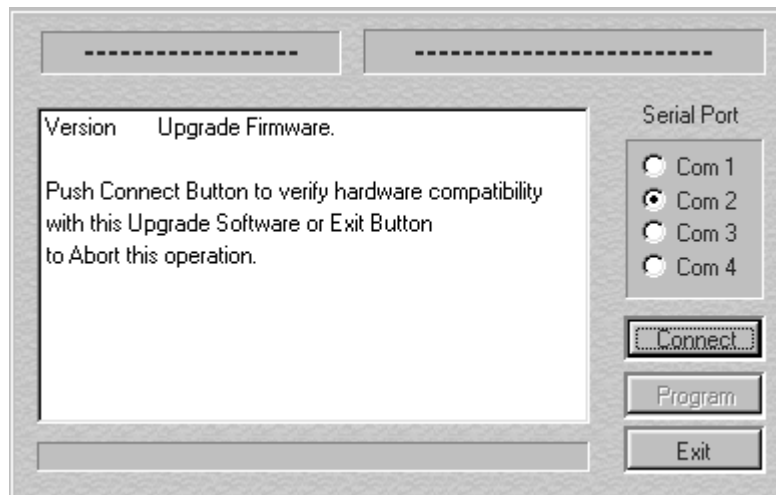

- J) Select the **PC serial port** on the screen
- K) Click **Connect** button

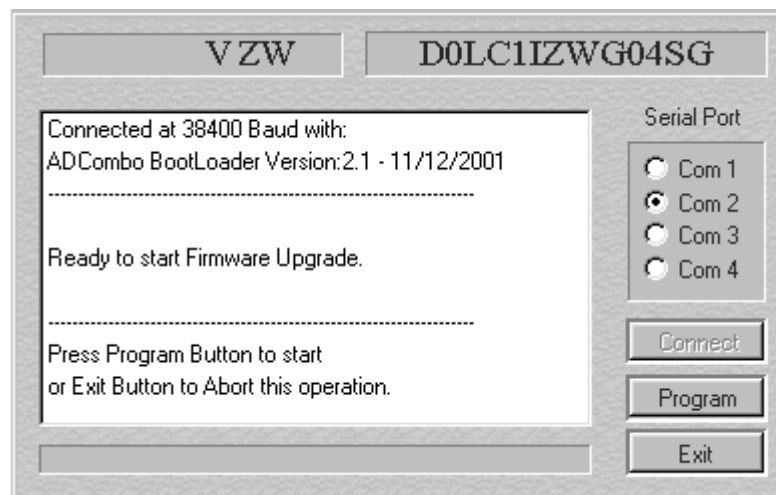

- L) Make sure the Identification is correctly done (*Ready to start Firmware Upgrade* message + firmware code displayed in the right field), and click '**Program**' button. The upgrade will continue automatically.
- M) Once you have completed the upgrade procedure, shut off the equipment
- N) Move the **jumper JP1** back to the previous position
- O) Turn the unit back on

HOW TO UPGRADE FROM *BASIC* VERSION TO *I-PS* VERSION

- A) Follow the procedure suggested at paragraph 1) and 2) up to Point G)
- B) **Unzip** the **Activation key file** supplied by the manufacturer
- C) **Make a copy on Yr local HD drive** of the ***Firmware_Upgrade*** folder provided on the CD ROM
- D) **Copy (or move) the Activation Key** (unzipped) into that ***Firmware_Upgrade*** folder
- E) Run the file **i-PS_Upgrade**
- F) Follow points I) throughout N) described at previous Paragraph

22 TECHNICAL SPECIFICATIONS

GENERAL

Weight	around 4.5 Kg
Dimensions	1 rack unit, 352 x 483 x 44 mm
Fuse	500 mA T for 230Vac

~ AC Rate	230 Vac 50 Hz / 110 Vac 60 Hz +/-10%
Op. temperature	-10 to 50 °C

AUX INPUT (1 and 2)

Connector Type	floating BNC, EMI suppressed
Pass-through Level	- 40dB to + 20dB trim adj. max 24 Vpp inp.
Distortion	< 0.03 %
Frequency response	30 Hz to 80 KHz +/- 0.1dB
Input Impedance	> 10 Kohm
Purpose	wide band MPX, SCA, RDS inputs

REMOTE COMPUTER INTERFACES

Available Ports	2 x RS-232
Connection Rate	19200 Baud
Communication	- Dedicated Remote Control software (supplied) for Win 95, 98, XP, NT, 2000 accordingly to UECP. SPB 490 (5.1) - ASCII Interface (with i-PS option installed)

SYNC-IN & SYNC-OUT

Connector Type	floating BNC, EMI suppressed
Sync-In	TTL for RDS synch. (ETS compliant)
Sync-Out	Not Used

REMOTE CONTROL (GPI) INTERFACE

Inputs	4, optoinsulated
Connector	SubD 15 pin, female
Purpose	TP, TA, M/S flag switching + Split control

RDS MODULATION

Signal generation	compliant to CENELEC EN50067 (1998)
Subcarrier freq.	57 kHz +/- 3 Hz
Bandwidth	+/- 2.5 kHz (- 60dB) / +/- 3.0 kHz (- 80dB)
Output Conn. type	floating BNC, EMI suppr. (50 Ohm)
Synchronization	to external pilot tone or Mpx signal. Automatic switchover to int. osc. in case of absence or low quality of ext ref. signal

RDS output level	0 to 1200 mVpp (5 mVpp step)
Linear Distortion	0.01 dB
RDS phase	+/- 120 deg (ref to MPX pilot). 1 deg step
Ext MPX summation	Ref to AUX IN 1&2 specifications

RDS PROGRAMMING

Command formats	compliant to UECP Forum document SPB 490 (Version 5.1 - 22.08.97) + extended manufacturer 's commands list ASCII interface for dynamic mode only
Static services	DI, PI, TP, TA, M/S, RT, AF, PS, PTY
Dynamic services	PS SEQUENCE, PS SCROLLING
RDS groups	0A (75%), 2A (25%) – FIXED SEQUENCE (0A, 0A, 0A, 2A)
Character tables	ISO 8859-1 (Latin 1), 8859-2 (Latin 2), 8859-5 (Cyrillic), 8859-7 (Greek), 8859-9 (Turkish), 8859-10 (Nordic)
AF lists	24, containing up to 25 freq each one
PS (basic version)	8 pages containing 20 PS each one + 1 Scrolling message - 24 hours / day scheduling capabilities
RT	8, with 24 Hours Day scheduling capabilities
PS (i-PS option)	8 pages containing 48 PS each one + 32 scrolling messages – instant broadcasting capabilities

OPTIONS AVAILABLE

i-PS	Software + firmware module for advanced management of up to 384 dynamic PS (includes software dedicated interface for DJ and ASCII programming support)
USB	Communication interface 1 USB + 1 RS-232 port
SPLIT	Internal switch to toggle between an external RDS/MPX signal ad signal auto-generated