

## COMPONENTS BASIK

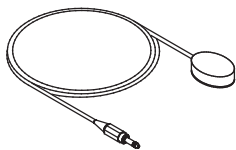

**BASIK TRANSDUCER**  
order code: ----



**APPLICATION PUTTY**  
order code: PUT-BASIK

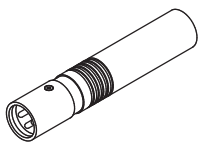

**PHANTOM 48V ADAPTER**  
order code: 48V-ADAPT



**PHANTOM POWER ADAPTER**  
order code: 1.5V-ADAPT

## THE BASIK CAN BE CONNECTED DIRECTELY TO:



STAT-PRE

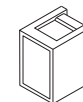

UNICO turn DC SUPPLY ON



PRE-A-III

turn DC SUPPLY ON



DAVID turn DC SUPPLY ON

## SPECIFICATIONS

OUTPUT IMPEDANCE .....	1000ohm
FREQUENCY RESPONSE .....	20 Hz to 20 KHz
S/N RATIO .....	60 dB
AV. SENSITIVITY ON THE INSTRUMENT .....	- 10 dBu
TEMPERATURE RANGE .....	- 20 to + 50°
CONNECTION .....	(1/4" + 1/8") mono Jack / 3 m cable

## APPLICATION ON THE INSTRUMENT:

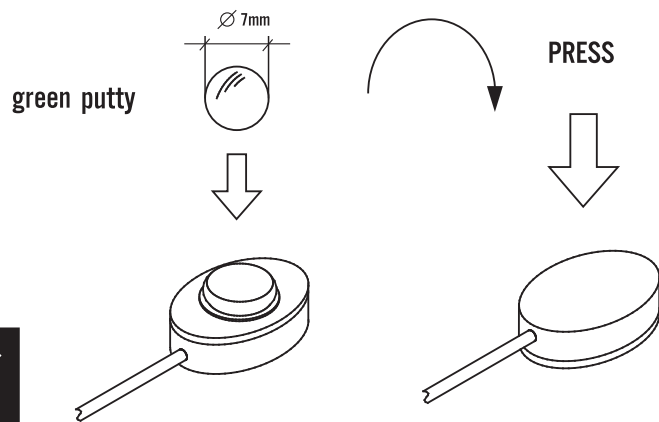

## BASIK-SET

### CONNECTION WITH THE POWER SUPPLY ADAPTER:

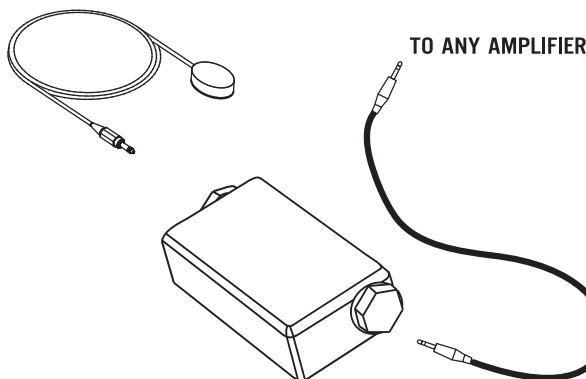

## BASIK-PRO

### CONNECTION WITH THE 48V ADAPTER:

TURN THE 48V  
PHANTOM POWER ON

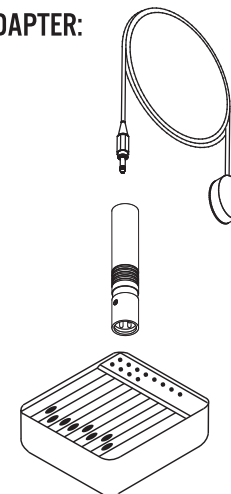

All Schertler® Products are covered by a limited two-year warranty (from the date of purchase) against manufacturers defects. Details can be obtained from your local dealer/representative. Schertler SA strongly believes in "common sense" and thus, misuse of our products are not covered under rights obtained through our warranty policy or that of internationally recognized terms and conditions. Schertler SA is constantly aiming to improve its range of products therefore, Schertler SA reserves the right to amend product specifications without notice. The Schertler® name/logo and BASIK® name are registered trademarks/tradenames of Schertler SA, Switzerland. All Schertler® products are of proprietary technology and covered by one or more worldwide patents.

**B A S I K**

### SCHERTLER SA

Via Beroldingen 18, 6850 Mendrisio  
Switzerland

Tel. +41 - 91 - 630 07 10

Fax +41 - 91 - 630 07 11

web-page: [www.schertler.com](http://www.schertler.com)

e-mail: [info@schertler.com](mailto:info@schertler.com)

Distributor or Dealer :

# SCHERTLER®

ACOUSTIC INSTRUMENT TRANSDUCER

SWISS MADE

[www.schertler.com](http://www.schertler.com)



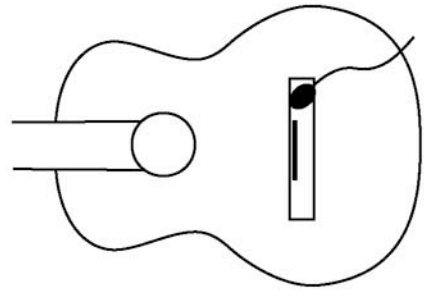

classic guitar

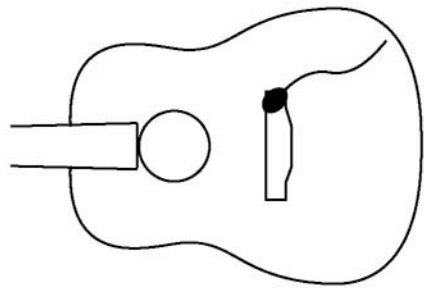

acoustic / western guitar

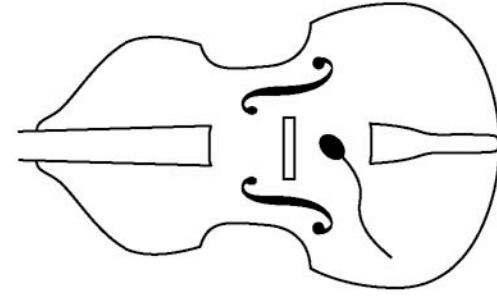

double-bass



cello



violin

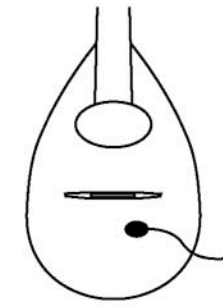

mandoline / lute

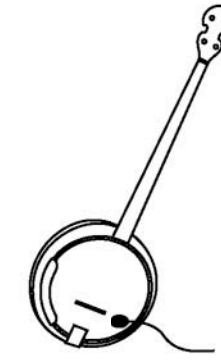

banjo

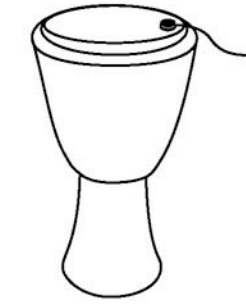

percussion

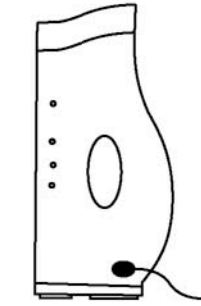

cithara

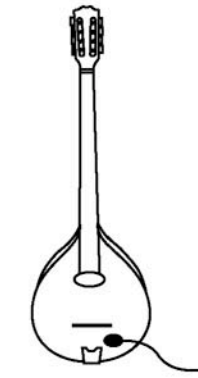

bouzouki

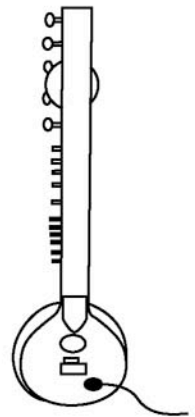

sitar

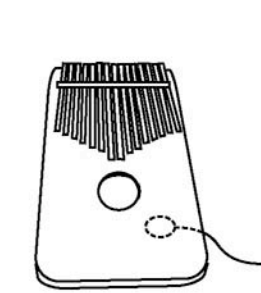

kalimba



harp

english :

Welcome to the world of SCHERTLER® and our latest innovative product for the amplification of acoustic instruments, BASIK®. This revolutionary acoustic transducer offers incredibly natural and, above all, individual sound reproduction for each member of the acoustic instrument family.

BASIK®, as do all SCHERTLER® products, takes into consideration the "musical aspects" of the application. We strive not only for a technical solution to amplifying an acoustic instrument, but to accurately reproduce the instrument's unique sound, not to recreate or reinvent it. The signal response is so dynamic that there is no need to change your playing style when amplified. The BASIK® also requires no visual modification of your precious instrument, no more unsightly blending units, volume knobs, etc.

Installation couldn't be easier with the inert putty included in the BASIK-SET. With the help of the manual you will locate the correct spot on your instrument for your perfect sound.

We hope to have improved your amplified sound and wish you years of satisfaction.

Stephan Schertler, Schertler SA.

deutsch :

Wir heissen Sie herzlich willkommen in der Schertler® Welt und freuen uns, Ihnen eines unserer neuesten innovativen Produkte vorzustellen: den BASIK®. Dieser qualitativ hochwertige und revolutionäre, akustische Tonabnehmer (Transducer), garantiert eine unbeschreiblich natürliche Klangwiedergabe für alle akustischen Saiteninstrumente.

Der BASIK®, wie alle Schertler® Produkte, berücksichtigt die "musikalischen Aspekte" bei der Benutzung.

Wir streben danach, für Probleme nicht nur eine technische Lösung zu finden sondern den einzigartigen Klang eines Instrumentes natürlich wiederzugeben. Im Vergleich zu anderen Systemen wird der Klang nicht neu erschaffen oder einfach nur ein "sound" produziert.

Das Signal ist so dynamisch, dass es auch bei Verstärkung nicht nötig ist, Ihren Spielstil zu ändern.

Mit der beiliegenden, grüne Knetmasse kann die Applikation nicht einfacher sein. Mit der Hilfe der Anleitung finden Sie die richtige Position auf Ihrem Instrument.

Wir wünschen Ihnen viele zufriedene Jahre mit Ihrem Instrument und ihrer überzeugenden akustischen Performance!

Stephan Schertler, Schertler SA

français :

Bienvenue dans l'univers SCHERTLER® et sa toute dernière innovation technologique dans l'amplification des instruments acoustiques: Le BASIK®. Ce capteur révolutionnaire, restitue un son complètement naturel et par-dessus tout la possibilité d'une amplification individuelle pour tous les instruments acoustiques. Ce produit a été conçu et réalisé pour vous offrir des performances inégalées à ce jour et un prix de vente très modique.

Le BASIK®, comme tous les produits SCHERTLER®, est essentiellement destiné à prendre en compte "l'aspect musical" dans son application. Le signal obtenu est tellement dynamique qu'il n'est plus nécessaire de modifier votre jeu pendant l'amplification.

L'installation est des plus faciles grâce à la pâte de fixation fournie avec le capteur : En suivant les explications ci-après, vous trouvez rapidement l'endroit idéal pour placer le BASIK® sur votre instrument.

Nous espérons avoir amélioré l'amplification de votre instrument et vous souhaitons des années de satisfaction.

Stephan Schertler, Schertler SA.

italiano :

Benvenuti nel mondo SCHERTLER® a contatto con l'ultimo dei suoi innovativi prodotti per l'amplificazione degli strumenti acustici, il BASIK. Questo rivoluzionario trasduttore offre un suono incredibilmente naturale rispetto ai normali trasduttori a contatto. Il sistema è stato disegnato e sviluppato per offrire un'ineguagliabile prestazione ad un costo limitato.

Il BASIK®, fedele alla filosofia dei prodotti SCHERTLER®, pone particolare attenzione all'aspetto musicale dell'applicazione. Grazie alla dinamica del segnale molto elevata non risulta necessario modificare lo stile adottato nel suonare. Il montaggio del BASIK® sullo strumento si presenta molto semplice grazie alla pasta di contatto fornita con il trasduttore: Attraverso il disegno dello strumento rappresentato sul manuale individuate la zona dove il suono vi soddisferà al meglio.

L'amplificazione del vostro suono vi sorprenderà, vi auguriamo piena soddisfazioni con il vostro strumento.

Stephan Schertler, Schertler SA.