

Super Audio CD / CD Player



K-01Xs



K-03Xs

### Organic EL Displays

The K-01Xs (K-03Xs) features smooth-operating, low-consumption electroluminescent (EL) display.



RC-1315 (K-01Xs) RC-1301 (K-03Xs)

### Specifications

#### Playable disc types

Super Audio CD, CD (including CD-R and CD-RW)

#### Analog audio outputs

XLR/ESL-A connector 1 pair (L/R)  
 RCA connector 1 pair (L/R)  
 Output impedance XLR: 84Ω ; RCA : 37Ω  
 Maximum output level (at 1kHz, 10kΩ load)  
 XLR: 5Vrms RCA: 2.5Vrms  
 Frequency response\* 5Hz to 55kHz (-3dB)  
 S/N ratio\* 120dB  
 Distortion\* 0.0008% (1kHz)

\*Super Audio CD, XLR output

#### Digital audio outputs

XLR connector 1  
 Output level 3 Vp-p (into 110Ω)  
 RCA connector 1  
 Output level 0.5 Vp-p (into 75Ω)

#### Digital audio inputs

RCA connector 1  
 Input impedance 75Ω  
 Input level 0.5 Vp-p  
 Optical digital connector 1  
 Input level -24.0 to -14.5dBm peak  
 USB-B port (USB 2.0 standard) 1

#### Clock input

BNC connector 1  
 Input impedance 50Ω  
 Frequencies that can be input(±10ppm)  
 44.1, 48, 88.2, 96, 176.4, 192kHz,  
 10, 22.5792, 24.576MHz

Input level  
 Rectangle wave equivalent to TTL levels  
 Sine wave 0.5 to 1.0 Vrms (50 - 75Ω)

#### General

Power supply AC 220-240V, 50/60Hz ; AC 120V, 60Hz ; AC 220V, 60Hz  
 Power consumption K-01Xs: 35W ; K-03Xs: 29W  
 External dimensions (W x H x D, including protrusions)  
 445 x 162 x 438mm (17 5/8" x 6 1/2" x 17 1/4")  
 Weight K-01Xs: 31kg (68 3/8 lb) ; K-03Xs: 28kg (61 3/4 lb)

#### Included accessories

Power cord set x 1 ; Remote control (K-01Xs: RC-1315 ; K-03Xs: RC-1301) x 1 ;  
 Batteries for remote control (AAA) x 2 ; Felt pads x 3 ;  
 Owner's manual x 1 ; Warranty card x 1



K-01Xs / K-03Xs

# ESOTERIC

## Super Audio CD/CD Player K-01Xs/K-03Xs



PROUDLY MADE IN TOKYO

# ESOTERIC

ESOTERIC COMPANY

1-47 Ochiai, Tama-shi, Tokyo 206-8530, Japan  
 Fax: (042) 356-9240  
[www.esoteric.jp](http://www.esoteric.jp)

Please note that Esoteric products are available at limited distributors in respective countries.  
 "ESOTERIC" and "VRDS" are trademarks of TEAC Corporation, registered in the U.S. and other countries.  
 "Grandioso" is a trademark of TEAC Corporation.

©2017 TEAC Corporation. All Rights Reserved. All text, images, graphics and other materials on this catalogue are subject to the copyright and other intellectual property rights of TEAC Corporation. These materials shall not directly or indirectly be published, reproduced, modified or distributed in any medium.  
 "Super Audio CD" and "DSD" are registered trademarks. "ASIO" is a trademark of Steinberg Media Technologies GmbH.  
 Other company names and product names in this document are the trademarks or registered trademarks of their respective owners.  
 Design and specifications are subject to change without notice.



PRINTED IN JAPAN 0714005 • TECD-0200

*Experience the ultimate beauty of music  
and a new depth to the art of playback  
from a device that exudes elegance.*

*The K series, the eternal icon of the Esoteric brand,  
is now updated to a new "Xs" edition.*

*The K-01 and K-03 are the Esoteric brand's most iconic integrated Super Audio CD players.  
First launched in 2010 before evolving to its second generation, the X edition, in 2014, it captivated  
people around the world with its incredible playback of music sources. These players have won more  
awards than any other Esoteric series, and have become the gold standard of digital players worldwide.  
And now this series has evolved again into a third generation, the Xs edition. Every part of these  
players is made from luxurious materials and cutting-edge technology, from the new DAC platform  
used in flagship models like the Grandioso K1 and N-01 to the latest digital input parts and the  
ES-LINK Analog transmission method, creating a new page in the history of digital players.*

Super Audio CD/CD Player

K-01Xs



Super Audio CD/CD Player

K-03Xs



# K-01Xs

VRDS-NEO [VMK-3.5-20S]

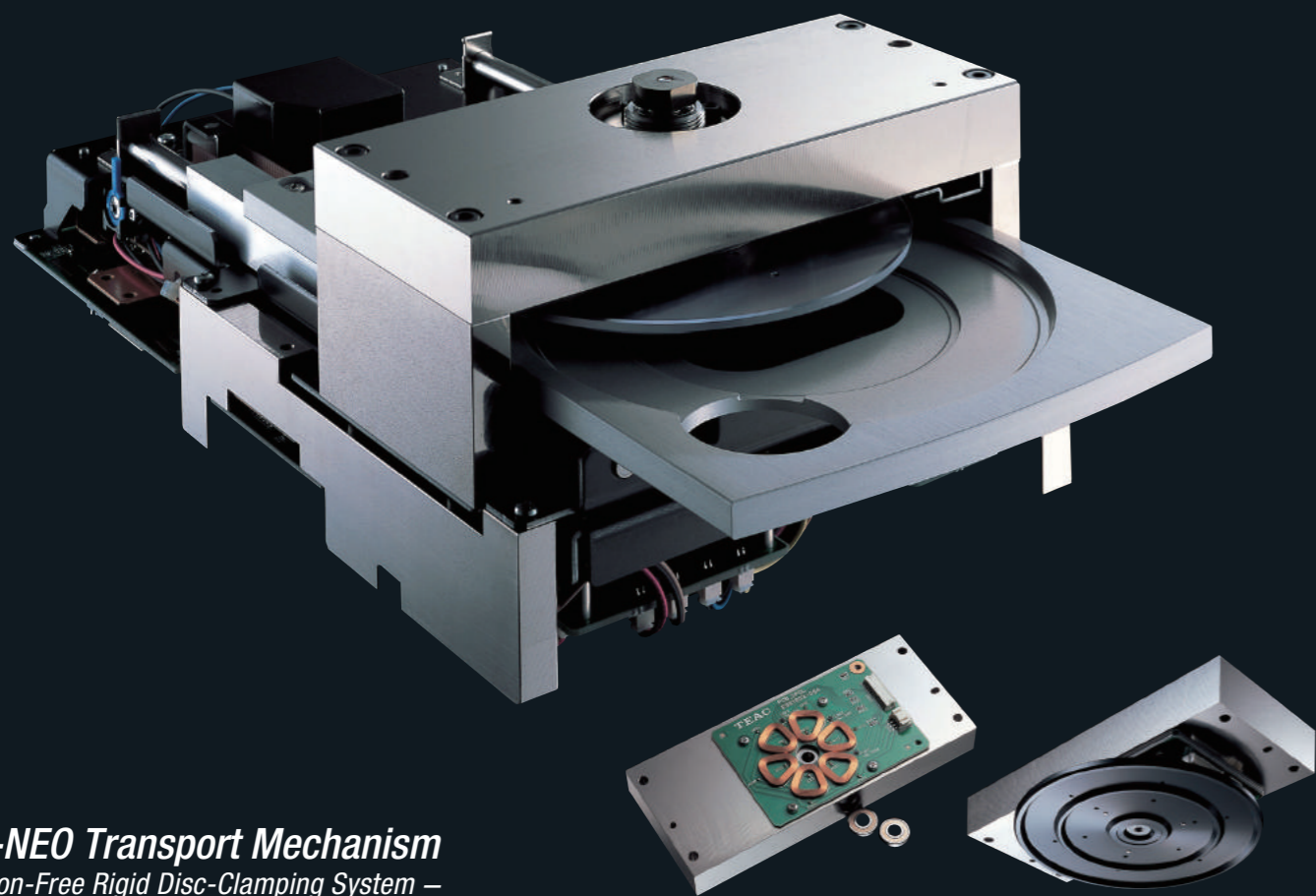

**VRDS-NEO Transport Mechanism**  
— Vibration-Free Rigid Disc-Clamping System —

*A new gold standard in digital players*

# K-01Xs

*Eight years after the release of the K-01, the ultimate in integrated digital players, comes the birth of the K-01Xs, a condensed version of Esoteric's flagship Grandioso model. The K-01Xs features the K series' classic construction with a high-rigidity chassis and a total of four power transformers in the power section, along with the high-precision VRDS-NEO [VMK-3.5-20S] turntable system used in the Grandioso P1/K1 and a pair of differential 8-circuit/channel monaural DACs following the latest DAC platform developed for the K1. Its extensive specifications are the gold standard in digital players, including the latest DAC (IC AK4497), a 35-bit D/A processing algorithm developed with Esoteric's patented proprietary technology; an HCLD buffer amplifier; DSD-compatible USB and a large custom low phase noise clock.*



## [ VRDS-NEO [VMK-3.5-20S] ]

Packed with Esoteric mechatronics, the VRDS uses a turntable to rotate CDs and Super Audio CDs, and mechanical correction of surface vibration is used to dramatically improve reading precision. Featured in the K-01Xs, the VRDS-NEO [VMK-3.5-20S] uses a pair of specially selected high-precision ball bearings for the spindle bearing as well as a duralumin turntable accurate within

microns and a 20mm-thick steel turntable bridge. The weight of the mega-unit is 5.2kg (12kg including the rigid base). It features a range of classic mechanisms including the coreless three-phase brushless spindle motor driven by a strong magnet and the VS-DD (VRDS Spindle Discrete Driver). These are combined with a quiet shutter mechanism\* in the tray to provide the ultimate precision.

\*A mechanism in which a shutter closes when the tray retracts and the shutter is mechanically locked into the front panel. This increases airtightness, reducing adverse effects from external sound pressure and vibration.

# K-03Xs

VRDS-NEO [VMK-3.5-10]

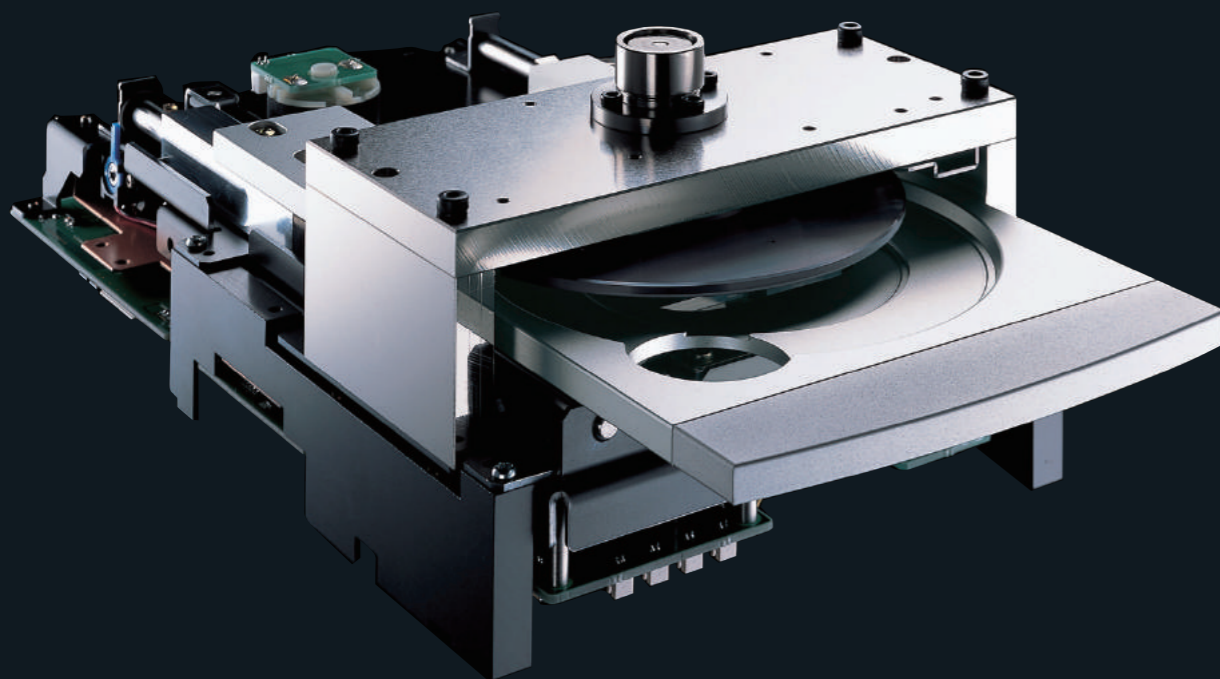

*The latest in a winning series*

# K-03Xs

*Carrying on the high-end concepts and technology from winning integrated players such as the Grandioso K1 and K-01Xs, the K-03Xs is what happened when we asked how far we could go, what heights we could reach with our performance model. The classic VRDS-NEO [VMK-3.5-10] drive mechanism contains a VS-DD circuit for smooth, quiet driving of the spindle. Developed based on the new DAC platform used in the Grandioso K1, the K-03Xs has a differential 4-circuit/channel dual mono DAC and Esoteric's patented proprietary 34-bit D/A processing algorithm. The essence of our flagship model can be seen throughout the K-03Xs, from many of the latest devices to the DSD-compatible USB and core sound quality features and functions.*



## [ VRDS-NEO [VMK-3.5-10] ]

The VRDS-NEO mechanism is used in our flagship model the Grandioso P1 to achieve the ultimate transportation precision. A high-precision turntable is used to rotate CDs and Super Audio CDs, with mechanical correction of surface vibration and dramatically improve reading precision. The K-03Xs takes this high precision even further with the

VRDS-NEO [VMK-3.5-10]. The VS-DD spindle servo driver is used for smooth, high-precision servo control. The mecha unit weighs 4.4kg, with a total weight of 11.2kg including the rigid base. The collection of heavyweight parts includes a duralumin turntable and a 10mm-thick steel turntable bridge. These are complemented by high-quality classics from the VRDS-NEO, such as the coreless three-phase brushless spindle motor driven by a strong magnet.

# "Xs" The Art of Mechanical Engineering and the Most Cutting-Edge Electronics

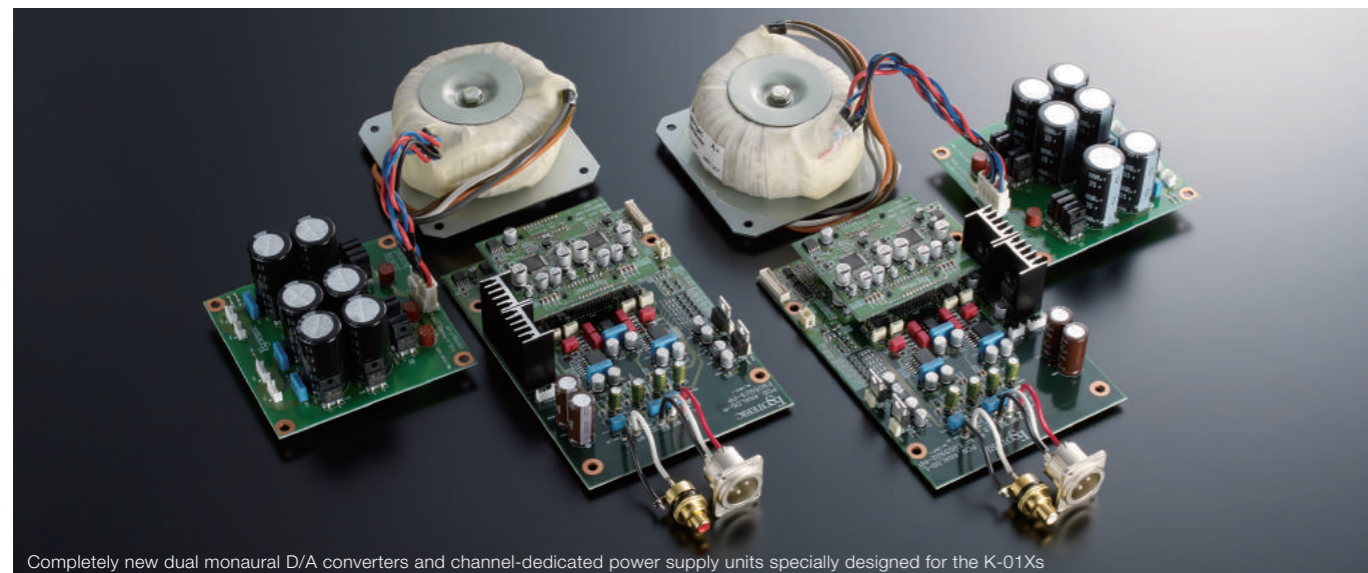

Completely new dual monaural D/A converters and channel-dedicated power supply units specially designed for the K-01Xs

## New Dual Mono D/A Converter

The D/A converter section was created based on the latest platform used in the Grandioso K1, with the very finest premium materials and circuit technology added to take it to the highest level of sound quality. The AK4497 32-bit premium DAC device from Asahi Kasei Electronics is combined with a high-quality operational amplifier (MUSES 02 in the K-01Xs and MUSES 8820 in the K-03Xs). The K-01Xs has 8 circuits per channel while the K-03Xs has a 4-circuit parallel/differential circuit structure for powerful linearity with minimal distortion. The circuit patterns of the DAC's power section have been further improved, with independent left and right power transformers in the K-01Xs to achieve a clean and highly stable power supply. Both the digital and analog circuits have more thorough isolation than previous models, achieving true-to-life playback with outstanding purity and superb sound stage depth.

## High-Bit D/A Processing with Outstanding Powers of Musical Expression (PAT. JP6043052)

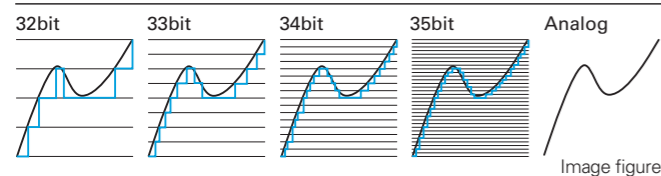

Image figure

Both the K-01Xs and K-03Xs combine multiple 32-bit DAC chipsets and utilize a high-bit D/A processing algorithm to convert the PCM signal to analog at a high resolution in excess of 32 bits. The K-01Xs supports 35-bit processing and the K-03Xs 34-bit processing. 35-bit processing achieves an astounding resolution that is fully 2,048 times that of 24-bit processing (34-bit processing being 1,024 times that of 24-bit processing). In the digital range, full advantage is taken of high-bit data gradation to minimize calculation errors and provide faithful conversion to analog, thereby attaining outstanding powers of expression with even extremely small music signals.

## ESOTERIC-HCLD\*: Esoteric's Exclusive Output Buffer Delivers Powerful Direct Current Transmission

The ability to produce comparatively large currents and high slew rates are two of the most important factors that enable an analog output circuit to accurately transmit the wide dynamic range of a music signal without degradation. The K-01Xs (K-03Xs) offers the ultimate performance as a line driver by adopting high-performance elements with a high current output and exceptionally fast slew rate (2,000V/μs) for excellent response speed. Two of these buffer circuits are employed per channel. By configuring them differentially to drive the XLR outputs and in parallel to drive the RCA outputs, the available instantaneous output current is maximized. By maximizing instantaneous current output, the K-01Xs (K-03Xs) reproduces the full dynamics of music with breathtaking realism.

\*HCLD=High Current Line Driver

## "ES-LINK Analog" Method for High Quality Current Transmission

In addition to regular line connections (XLR and RCA), the K-01Xs (K-03Xs) features Esoteric's new "ES-LINK Analog" transmission method. This is a current transmission method that utilizes the high performance of the HCLD buffer circuit and its enhanced ability to supply high-speed current. This is the ideal analog audio transmission as it is free from signal route impedance, thus fully maximizing the system's potential when connected to a compatible device.\*

\*A standard balance cable (with an XLR terminal) is used for connections, but the "ES-LINK Analog" method is a proprietary transmission method which can only be used with compatible devices.

## Wide Range of D/D Conversion According to Source

In addition to the original Fs playback, this series has a function for up-conversion of PCM digital signals by 2x, 4x, 8x or 16x (maximum 768kHz). It also features a PCM > DSD conversion function using a proprietary algorithm. DSD is up-converted to 22.5MHz. The unit also features a DSD digital filter that can be turned on or off as desired.

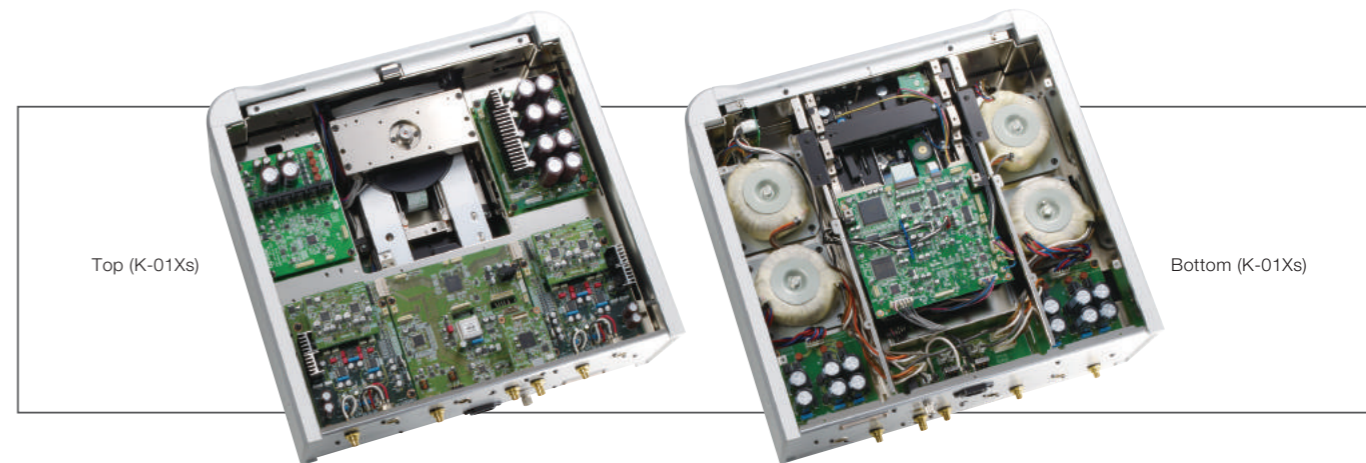

Top (K-01Xs)

Bottom (K-01Xs)

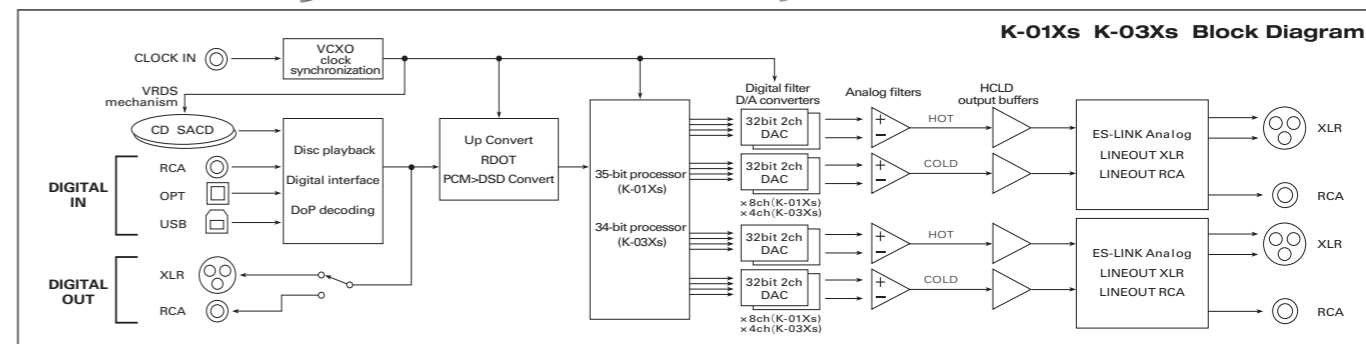

## Digital Inputs

Three digital inputs (USB, coaxial, and optical) enable connection to a wide range of systems. Coaxial and optical inputs support DSD 2.8 MHz (DoP) input and PCM of up to 192 kHz/24-bit.

## USB Audio Interface Compatible with DSD22.5MHz, PCM768kHz/32bit and Asynchronous Transmission

The unit is equipped with a USB port enabling connection to a computer. The driver and playback software (Esoteric HR Audio Player) can be downloaded from the Esoteric website. The unit supports asynchronous transmission and a high sampling playback of DSD22.5MHz and PCM768kHz/32bit, and even enables high-quality playback of studio master quality sources. In addition to conventional asynchronous transmission methods, it supports the new Bulk Pet method for an even wider range of tone selection.

## High-Precision VCXO Clock

The clock circuit supplies a high-accuracy reference clock signal to the digital circuitry. The Grandioso Custom VCXO (voltage-controlled crystal oscillator) is a high-precision custom clock that utilizes a large crystal element to ensure exceptional sound quality with excellent center accuracy (±0.5ppm) and extremely low levels of phase noise.

## Clock Sync Function for Synchronization with External Devices

Connecting the K-01Xs (K-03Xs) to a high-precision master clock generator such as the G-01X or the G-02X allows synchronization of the unit's operation with an external clock signal, thereby enabling the quality of the system to be further upgraded. Synchronization with an external clock is also available when USB input is used.

## Output Modes

The analog audio output can be switched between ES-LINK Analog, RCA, and XLR. Hot 2 or Hot 3 XLR pin assignments can also be selected. Loss in audio quality is eliminated with a non-contact system by performing phase inversion in the digital domain.

## Support for Future System Upgrades

RCA (S/PDIF) or XLR (AES/EBU) digital outputs are provided. These allow the player's performance to be upgraded by the addition of a top-end Esoteric D/A converter.

\*This circuit can be turned off when digital output is not in use.

## Chassis Construction and Parts Layout

The VRDS-NEO transport mechanism is positioned in the center of the unit, directly attached to the 5 mm-thick steel chassis bottom, and is supported at three points by Esoteric's proprietary

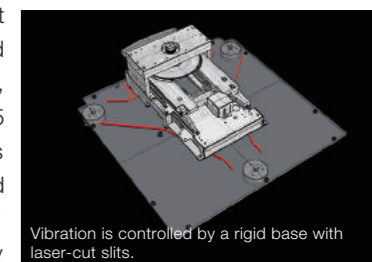

Vibration is controlled by a rigid base with laser-cut slits.

pinpoint feet (Patent No. 4075477 and 3778108) to effectively suppress vibration. The chassis interior features a double-deck construction. The audio boards are located on the upper layer of the chassis, being isolated from the power supply components on the lower layer, and the power supply wiring has been made as short as possible. The K-01Xs features four large toroidal transformers: one for each of the two built-in monaural D/A converters, one for the audio circuitry, and one for the VS-DD spindle servo driver. The K-03Xs is equipped with two large toroidal transformers: one for the analog circuitry and the other for the digital/mechanism drive circuitry. This design provides ideal power supply capability to all circuit blocks without interference.