

X23

2-
3-



www.altoproaudio.com

- -



ON:
OFF:

WARNING:

CAUTION:

(Fuse)

,
LTO AUDIO. LTO,
— , ...
!
LTO
, ,
(DSP) ,
7 .
, ,
, ,
, !
LTO — , «
».
- ,
, LTO , LTO,
, — ,

LTO AUDIO

1.				4
2.				4
3.				4
	3.1				
		a.			
		b.			
	3.2				
		a.			
		b.			
4.			&	7
	4.1				
	4.2				
	4.3.				
5.				8
	5.1	23	2-		
	5.2	23	3-		
6.				10

1.

LTO 23 – U, 23, () 3-
 () - ()
 23
 CD Horn Equalization ()
 23 -

2.

1 U
 / XLR, ¼- / TRS
 , 24 /
 Mute
 115
 ISO9001

3.

3.1

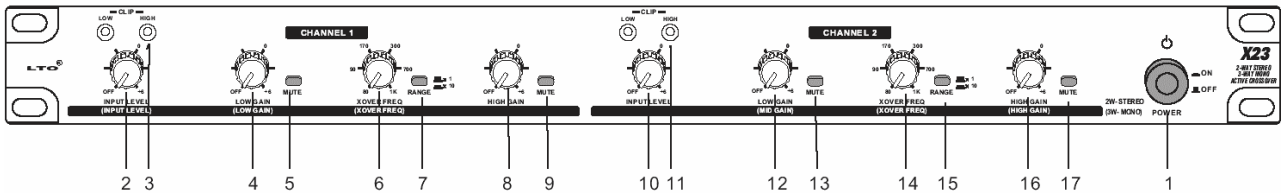

	24 – 2- () / 3- ()	()
	2-	3-
1.		
2.	1,	
3.	1,	
4.	1,	()
5.	1,	()
6.	1,	()
7.	1,	()
8.	1,	()
9.	1,	-

10.	2,	()
11.	2,	
12.	2,	
13.	2,	
14.	2,	-
15.	2,	
16.	2,	
17.	2,	()

b.

- **POWER (1)**
- /
- **CLIP (3)** 1 11 2)
- **MUTE (5, 9)** 1 13, 17 2)

3.2 :

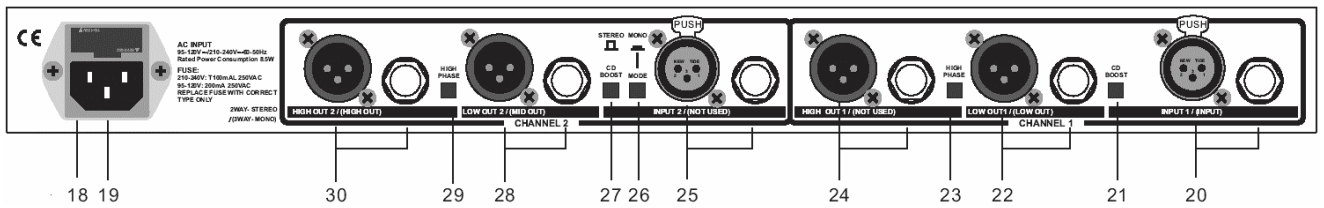

	23 - 2-	() / 3-	()
	2-		3-
18.			
19.			
20.	1,		
21.	1,		
22.	1, -		()
23.	1,		()
24.	1, -		()
25.	1,		()
26.	1, -		-
27.	2,		()
28.	/		
29.	2,		()
30.	2, -		
31.	2, -		-

b.

(22 23)



100-120

220-240

3

(

).

1800

(20 22, 24

1, 25, 28 30

2)

(« »).

• CD Boost
1 27

2)

(21

+3 3,5

6 / 22,5

«CD BOOST»,

(

).

(23

1 29

2)

180°.

(26)

(/ / /).

4-

(/ /).

3-

4. & :

4.1

X34

34,

[POWER]
/

4.2

LTO 34
XLR 1/4" TRS Jack.

a.

1/4" TRS (Tip-Ring-Sleeve) XLR

-

1/4" TRS



1/4" TRS



1/4" TRS

-

XLR



XLR



XLR

b.

XLR, 1/4" TRS,

-

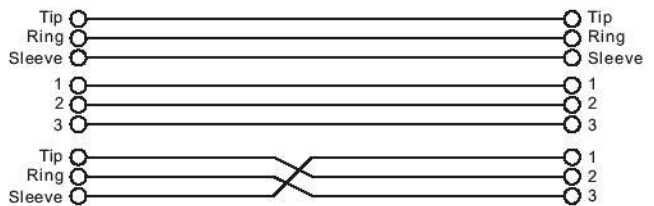
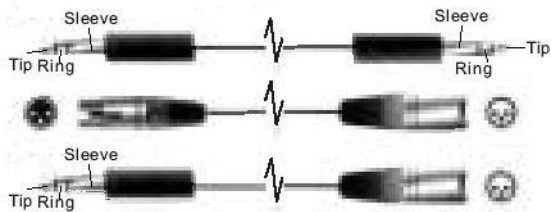

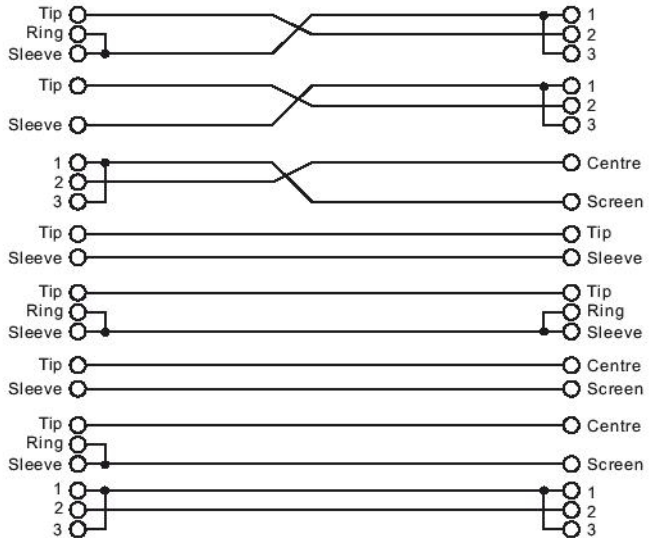
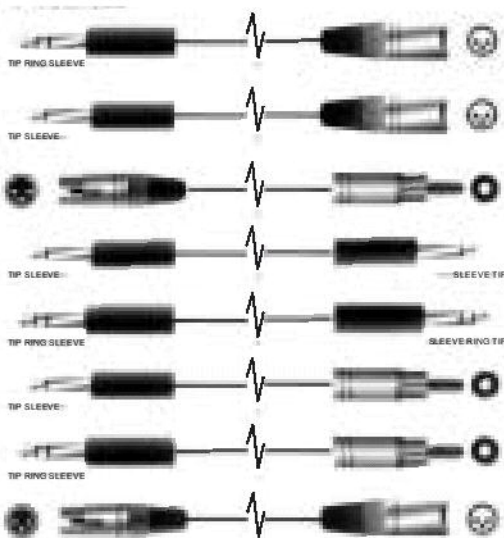

4.3.

5.

5.1. 23 2-

23 2-

	Mode	INPUT 1	INPUT 2.
1.			
2.			
3.	-	LOW OUT 1	- , - LOW OUT 2
4.	-	MID OUT 1	- , - MID OUT 2
5.	-	HIGH OUT 1	- , - HIGH OUT 2

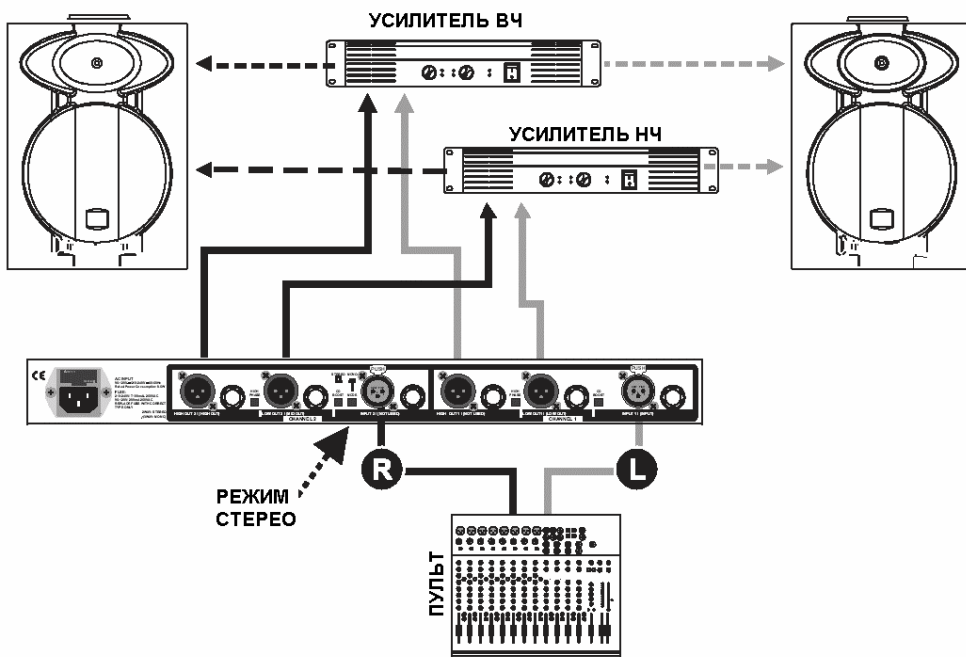

5.2. 23 3-

23 3-

1. Mode
2. INPUT 1.
3. LOW OUT 2
4. HIGH OUT 2
5. HIGH OUT 1

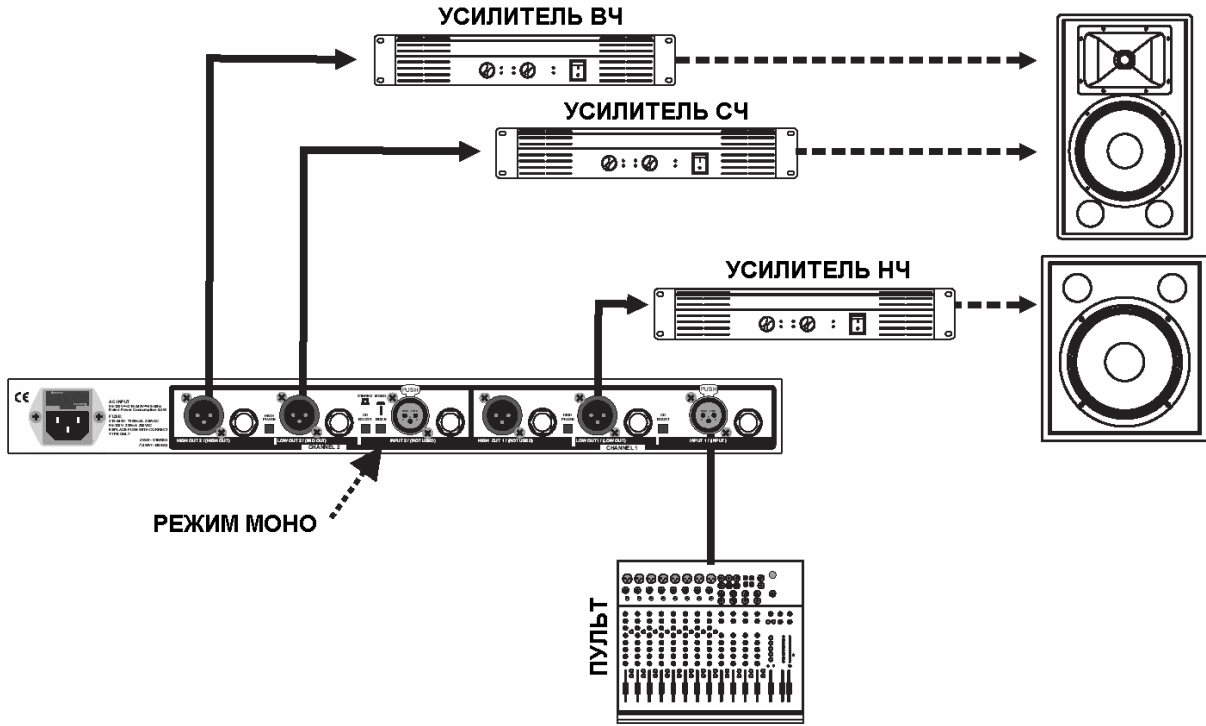

INPUT 2.
LOW OUT 1 MID OUT 1.

INPUT 1
LOW Gain 1
XOVER FREQ 1
HIGH Gain 1
INPUT 2
LOW Gain 2
XOVER FREQ 2
HIGH Gain

6.

:

-
-
(0)
(0)
(0)
/

90 -1
800 -10
AV = 0 , fc = 230 , 2,3
<- 98 dBu
<- 95 dBu
<- 93 dBu
114

:

INPUT LEVEL ()
OUTPUT LEVEL ()
CD Boost ()
MUTE ()
PHASE ()

, , ,
, , ,

:

3- IEC,
- ,
115 230 , 50/60
10

:

483 194,5 44
2,5