

Conference System SDC 8200

System Manual

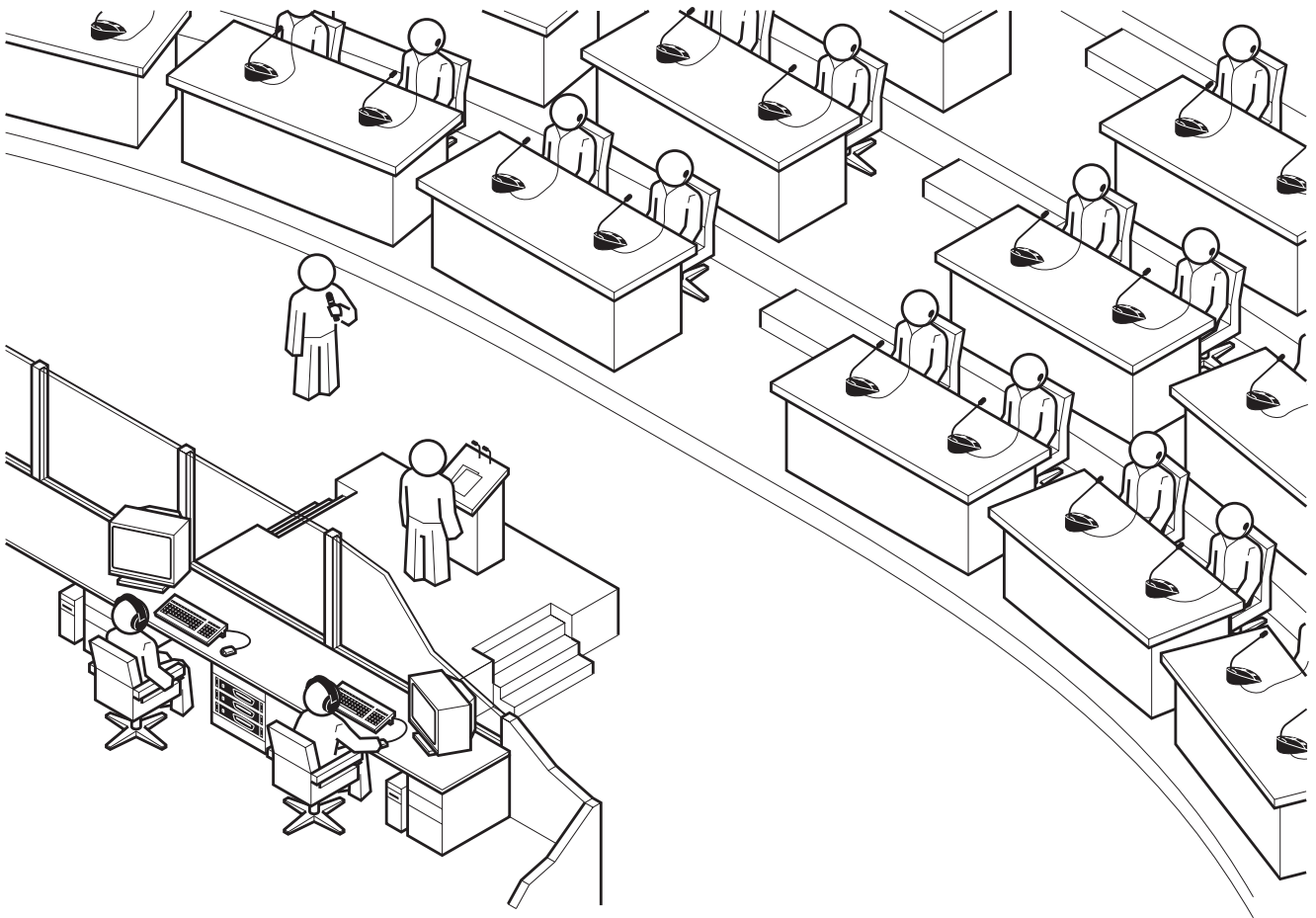

Thank you for choosing Sennheiser!

We have designed this product to give you reliable operation over many years. Over half a century of accumulated expertise in the design and manufacture of high-quality electro-acoustic equipment have made Sennheiser a world-leading company in this field.

Please take a few moments to read these instructions carefully, as we want you to enjoy your new Sennheiser products quickly and to the fullest.

Contents

Safety information	8
SDC 8200 – the digital conference and interpretation system	10
Overview of the components of the SDC 8200 system	11
The conference consoles	11
The interpreter consoles	12
The central units	12
The SDC 8200 CU central unit	12
The SDC 8200 CU-M central unit	13
The system cables	13
The software control	13
The technology used	14
The components of the SDC 8200 system in detail	15
The consoles	15
SDC 8200 D conference unit	17
SDC 8200 C chairman unit	18
SDC 8200 DC conference unit	19
SDC 8200 CC chairman unit	20
SDC 8200 DV conference unit	21
SDC 8200 CV chairman unit	22
SDC 8200 ID interpreter console	23
The SDC 8200 CU central unit	24
The SDC 8200 CU-M central unit	25
The SDC 8200 AO analog output unit (optional)	26
The system cables	27
Operating the components of the SDC 8200 system	28
Operating the delegate units	28
Taking the floor / Making a request to speak	28
Turning off the microphone / Cancelling a request to speak	32
Adjusting the volume of the headphones connected to a conference console	32
Selecting an interpretation channel	33
Voting	33
Using the chip card slot of a conference console	34
Operating the VIP units	34
Operating the chairman unit	35
Turning all active conference consoles off (priority)	35
Starting a voting session	35
Assigning a participant the “speaking right”	36
Showing the request-to-speak list on the displays of the conference consoles	36
Operating the interpreter consoles	37
Adjusting the volume and the middle and treble response of the headphones connected to the interpreter console	37
Adjusting the volume of the interpreter consoles’ built-in loudspeakers	38
Configuring the B-channel of an interpreter console	38
Setting the channel to be output via the interpreter console’s built-in loudspeaker	38
Selecting an interpretation channel	38
Using the interpreter console	39
Switching between the A-channel and the B-channel	39
Muting the microphone of the interpreter console	39

Displaying text messages on the interpreter console's display	40
Operating the central unit	40
Adjusting the volume of the consoles' built-in loudspeakers	40
Restarting the conference and interpretation system	40
The F1, F2 and F3 function keys	40
The menu operating controls	41
Working with the central unit's operating menu	41
Structuring the SDC 8200 system	43
Interconnecting the conference/interpreter consoles	43
Connecting cable strings to a central unit	43
Interconnecting up to twelve SDC 8200 CU central units	43
The three expansion stages	44
Expansion stage (1): one central unit with up to 20 consoles	44
Expansion stage (2): one central unit with up to 120 or 50 consoles	45
Expansion stage (3): several interconnected SDC 8200 CU central units with up to 1024 consoles	46
Determining maximum cable lengths	46
Calculating the voltage drop on the system cables	47
Structuring an interpretation system	47
Selectable modes between or within interpreter booths	48
Mode between booths: "Mixed"	48
Mode between booths: "Override"	48
Mode between booths: "Toggle Override"	48
Mode in booths: "Mixed"	49
Mode in booths: "Toggle Override"	49
The "auto-floor" function	49
Using external equipment	51
Connecting external audio sources	51
Transmitting the floor channel and the interpretation channels to broadcasting and TV stations	52
Transmitting the floor channel or an interpretation channel via a PA system	52
Transmitting the floor channel and the interpretation channels via an infrared transmission link	52
Setting up the SDC 8200 system	53
Preparing the SDC 8200 system components for set up	53
Conference and interpreter consoles	53
Central unit	53
Rack-mounting several SDC 8200 CU central units	53
Interconnecting the SDC 8200 system components	53
Interconnecting the consoles	54
Connecting a cable string to the central unit	54
Interconnecting several central units (SDC 8200 CU central unit only)	54
Turning the interconnected SDC 8200 CU central units on and off	55
Exiting the "slave" mode of a central unit	55
Connecting additional equipment	56
Connecting external audio sources	56
Setting up remote conferences	57
Connecting PA systems, recording units, etc.	57
Pin assignment of the 15-pole sub-D socket (AUX OUT 2-3-4-5-6)	57
Connecting an SDC 8200 AO analog output unit to the SDC 8200 CU central unit	58
Connecting several SDC 8200 AO analog output units to the SDC 8200 CU central unit	58
Connecting external equipment to the SDC 8200 AO's phoenix connector	59
Connecting a PC to the central unit	60
Configuring the SDC 8200 system	61

Introduction to the central unit's operating menu	61
The start display	61
The six main menus	61
The submenus of the "Conference" menu (part 1 of 7)	63
The submenus of the "Conference" menu (part 2 of 7)	64
The submenus of the "Conference" menu (part 3 of 7)	65
The submenus of the "Conference" menu (part 4 of 7)	66
The submenus of the "Conference" menu (part 5 of 7)	67
The submenus of the "Conference" menu (part 6 of 7)	68
The submenus of the "Conference" menu (part 7 of 7)	69
The submenus of the "Interpretation" menu (part 1 of 5)	70
The submenus of the "Interpretation" menu (part 2 of 5)	71
The submenus of the "Interpretation" menu (part 3 of 5)	72
The submenus of the "Interpretation" menu (part 4 of 5)	73
The submenus of the "Interpretation" menu (part 5 of 5)	74
The submenus of the "Aux-In/Out" menu (part 1 of 8)	75
The submenus of the "Aux-In/Out" menu (part 2 of 8)	76
The submenus of the "Aux-In/Out" menu (part 3 of 8)	77
The submenus of the "Aux-In/Out" menu (part 4 of 8)	78
The submenus of the "Aux-In/Out" menu (part 5 of 8)	79
The submenus of the "Aux-In/Out" menu (part 6 of 8)	80
The submenus of the "Aux-In/Out" menu (part 7 of 8)	81
The submenus of the "Aux-In/Out" menu (part 8 of 8)	82
The submenus of the "System" menu (part 1 of 2)	83
The submenus of the "System" menu (part 2 of 2)	84
The submenus of the "Language" and the "License" menu (part 1 of 1)	85
Setting the volume of the consoles' built-in loudspeakers	86
Configuring the conference system	86
Turning on the central unit for the first time	86
Automatically initializing all conference consoles	86
Manually initializing all conference consoles	87
Loading the factory-preset default configuration for the conference system	87
Adding a conference console to an already existing configuration	87
Removing a conference console from an already existing configuration	88
Reserving a microphone number	88
Selecting a conference mode	89
Setting the speaker limit	90
Adjusting the audio settings for the consoles' built-in loudspeakers	90
Adjusting the audio settings for the consoles' microphones	91
Configuring additional chairman units (Chairmen)	92
Deleting the list of chairman units (Chairmen)	92
Configuring additional VIP units (VIP)	92
Deleting the list of VIP units (VIP)	93
Activating/deactivating the special rights of the VIP units (VIP)	93
Resetting the conference system (Reset)	93
Testing the consoles' built-in loudspeakers	93
Testing the consoles' microphones	94
Activating/deactivating the flashing of the signal light ring	94
Configuring the display of the voting options	94
Configuring the interpretation system	95
Working with the interpreter configuration	95
Creating a new interpreter configuration	95
Modifying the currently active interpreter configuration	96
Loading a previously saved interpreter configuration	97
Options	97
Setting the max. number of interpreter booths/languages	98

Setting the max. number of interpreter consoles per booth	98
Configuring the operating mode between booths	98
Configuring the operating mode within a booth	99
Configuring the language options for the interpreter booths	99
Configuring the main target language (A-channel) of a booth	100
Configuring the second target language (B-channel) of a booth	100
Enabling the auto-relay interpretation function (Auto-floor)	101
Half-automatically initializing all interpreter consoles on the central unit	101
Manually assigning an interpreter console an individual booth number	102
Manually assigning an interpreter console an individual desk number (interpreter console number)	103
Displaying the booth and desk number of an interpreter console	104
Adding interpreter consoles to an existing configuration	104
Loading the factory-preset default configuration for the interpretation system	104
Resetting the interpretation system	105
Configuring the audio inputs and outputs	105
Choosing the audio inputs and outputs	105
Adjusting the volume of the audio outputs	106
Adjusting the volume differences between the Aux Out 1 outputs	107
Assigning a channel to an audio output	107
Turning on/off the audio inputs or outputs	108
Adjusting the volume differences between the headphone outputs	108
Configuring the audio outputs for remote conferencing	109
Turning on/off an external equalizer	109
Adjusting the input level of an audio input	110
Adjusting the input sensitivity of an audio input	110
Configuring the outputs of the SDC 8200 analog output unit	110
Making a system diagnosis	112
Displaying the number of consoles connected to the central unit	112
Checking the communication within a cable string	112
Configuring connected additional components	112
Turning on/off a camera control	112
Turning on a connected control panel	113
Configuring an "ambient sound" console	113
Software, language and license	114
Displaying the version number of the central unit's software	114
Choosing the language of the central unit's operating menu	114
Displaying the central unit's serial number	115
Displaying the license code of your conference and interpretation system	115
Upgrading the license of your conference and interpretation system	115
If problems occur...	116
Replacing a fuse	116
Conference/interpreter console does not work	116
Only the microphone of the chairman unit can be activated	116
No audio signal can be heard through the consoles' built-in loudspeakers	116
Maintenance and care	116
Accessories	117
System components	117
Software for PC controlling the SDC 8200 CU central unit	117
Software for PC controlling the SDC 8200 CU-M central unit	117
System cables	117
Licenses for expanding the SDC 8200 CU central unit	117

Specifications	118
Features of the central units	118
Consoles	118
SDC 8200 D	118
SDC 8200 C	119
SDC 8200 DC	119
SDC 8200 CC	120
SDC 8200 DV	120
SDC 8200 CV	121
SDC 8200 ID	121
SDC 8200 CU central unit	122
SDC 8200 AO analog output unit	123
RJ 45 cable	123
Appendix A: Camera control protocol	124
The syntax of the commands	124
Commands:	125
Appendix B: Control panel protocol	126
Commands	126
The commands sent by the central unit and received by the control panel:	127
The commands sent by the control panel and received by the central unit:	127
Appendix C: Repeater for the SDC 8200 system	128
Manufacturer declarations	129
Warranty regulations	129
CE Declaration of Conformity	129
WEEE Declaration	129

Safety information

The Sennheiser SDC 8200 conference and interpretation system is state of the art and has been designed to meet the regulations in force. Nevertheless, the individual components of the SDC 8200 conference and interpretation system can cause danger for persons and material assets if:

- the system is not used as intended,
- the system is set up by personnel not familiar with the safety regulations,
- the system is converted or altered incorrectly,
- the following safety instructions are not observed.

Warning!

If the components of the conference and interpretation system are set up improperly, persons can stumble over cables, fall and suffer serious injury! This can also cause severe damage to units and cables.

Place the components of the system on flat surfaces only. Lay the cables in such a way that no-one can stumble over them.

Caution!

The central units generate heat! If the heat generated cannot dissipate, the central units can be destroyed or combustible materials nearby can catch fire.

Make sure that the air vents of the central units are not covered or blocked. Keep combustible materials away from the central units.

Caution!

If liquids or small parts which conduct electricity find their way into the interior or to the sockets or plug contacts of the units, this can cause a short circuit which may damage the units!

Keep liquids and small parts which conduct electricity away from the units! Before cleaning the units, disconnect all central units from the mains by removing the plug. For cleaning the system components, only use a slightly damp cloth. Do not use solvents as they can damage the surfaces.

Caution!

If you connect defective or unsuitable accessories, the system components can be destroyed!

Only use the connection cables available from Sennheiser electronic GmbH (see "The system cables" on page 27). Sennheiser makes no warranty as to cables not manufactured by Sennheiser.

Attention! High Volume!

This is a professional conference system. Commercial use is subject to the rules and regulations of the trade association responsible. Sennheiser, as the manufacturer, is therefore obliged to expressly point out possible health risks arising from use.

This system is capable of producing sound pressure exceeding 85 dB(A). 85 dB(A) is the sound pressure corresponding to the maximum permissible volume which is by law (in some countries) allowed to affect your hearing for the duration of a working day. It is

used as a basis according to the specifications of industrial medicine. Higher volumes or longer durations can damage your hearing. At higher volumes, the duration must be shortened in order to prevent damage. The following are sure signs that you have been subjected to excessive noise for too long a time:

- You can hear ringing or whistling sounds in your ears.
- You have the impression (even for a short time only) that you can no longer hear high notes.

Warning!

This is a class A product. In a domestic environment this product may cause radio interference in which case the user may be required to take adequate measures.

SDC 8200 – the digital conference and interpretation system

The new SDC 8200 conference and interpretation system from Sennheiser utilizes all advantages of digital communications technology and offers its users a series of important features:

- Decentralized, clear sound reproduction
- Excellent speech intelligibility due to 16-bit audio transmission
- Easy installation and straight-forward operation
- Conference consoles are extremely easy to operate
- Delegate interaction (e.g. with voting sessions)
- Interpretation facility
- Extended functionality
- Possibility of connecting an infrared language distribution system

SDC stands for Sennheiser Digital Conference System – the new generation of mobile and expandable conference and interpretation equipment.

The SDC 8200 conference and interpretation system is an ideal choice for both small seminars with up to 20 participants and large international conferences with a maximum of 1024 participants.

An important feature of the SDC 8200 conference and interpretation system is its modular design. Even if, at first, the system is only required for small conferences, you can later easily add conference consoles and a software control program. In any case, the conference and interpretation system can:

- be set up quickly, since all consoles are connected in series (single-cable system),
- be adapted easily to any room and any number of participants.

Overview of the components of the SDC 8200 system

An SDC 8200 conference and interpretation system consists of the following components:

- Conference consoles for delegates and chairmen
- Interpreter consoles
- Central units
- System cables
- If required, a software control for the conference and interpretation system

The conference consoles

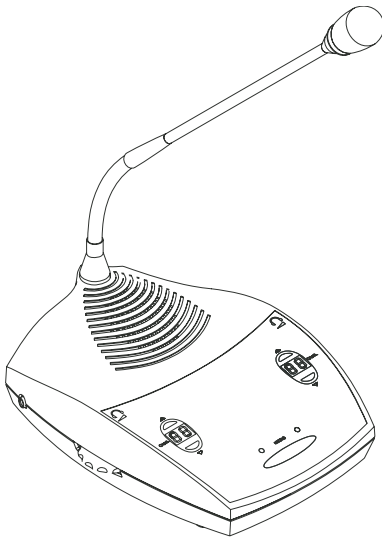

The conference console features a built-in loudspeaker, allowing the participant to directly hear all audio information, e.g. speeches, presentations or any other audio material. This decentralized “loudspeaker system” ensures excellent sound quality at a pleasant volume throughout the entire room.

The console’s electret microphone transmits every word in excellent audio quality. The red signal light ring on the microphone serves as an indicator of who is allowed to take the floor.

The conference consoles are available in six different versions with varying levels of functions. All conference consoles have voting keys, allowing all conference participants to participate in voting sessions from their consoles.

The conference consoles can also be operated with a central unit from the SDC 8000 conference and interpretation system. In this case, the functionality of the conference consoles depends on the functions and features of the central unit. The conference consoles are connected in series. One cable string can comprise up to 20 conference consoles and up to six cable strings (i.e. up to 120 conference consoles) can be connected to a single central unit. You can, however, interconnect several central units to set up conference systems with up to 1024 consoles.

The interpreter consoles

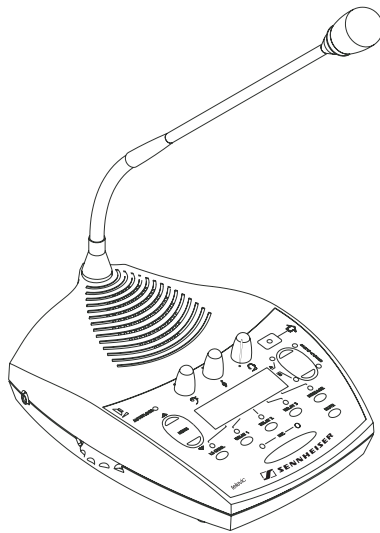

The interpreter console incorporates all functions of a conference console but offers additional features required by the interpreters.

The interpreter consoles are required if simultaneous interpretation is offered at a conference.

The central units

You can choose between the SDC 8200 CU central unit for larger and the SDC 8200 CU-M central unit for smaller conference systems (see "Features of the central units" on page 118).

Both central units can also be operated with conference consoles from the SDC 8000 conference and interpretation system.

The SDC 8200 CU central unit

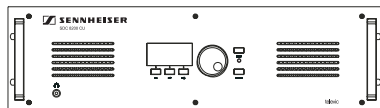

The SDC 8200 CU central unit is the core of the SDC 8200 conference and interpretation system and, at the same time, serves as an interface for additional audio systems.

Via the operating menu of the SDC 8200 CU central unit, the conference and interpretation system can be configured for any room, any number of participants and any conference use.

The central unit serves to manage the entire conference and interpretation system.

On the SDC 8200 CU central unit, you can choose between ten conference modes. However, the selection of some of the conference modes only makes sense if your conference and interpretation system is PC controlled.

The SDC 8200 CU central unit has a built-in power supply for powering up to 120 conference consoles. For larger conference systems, up to 12 central units can be interconnected.

The interpretation capacity of the central unit is 28 languages. Two different licenses are available for eight or 28 interpretation channels. The floor channel and four interpretation channels can be operated license-free.

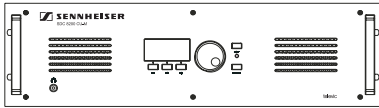

The SDC 8200 CU-M central unit

The SDC 8200 CU-M central unit is the core of the SDC 8200 conference and interpretation system and, at the same time, serves as an interface for additional audio systems.

Via the operating menu of the SDC 8200 CU-M central unit, the conference and interpretation system can be configured for any room, any number of participants and any conference use.

The central unit serves to manage the entire conference and interpretation system.

On the SDC 8200 CU-M central unit, you can choose between ten conference modes. However, the selection of some of the conference modes only makes sense if your conference and interpretation system is PC controlled.

The SDC 8200 CU-M central unit has a built-in power supply for powering up to 50 conference consoles. However, it is not possible to interconnect several SDC 8200 CU-M central units in order to realize larger conference systems.

The floor channel and four interpretation channels can be operated license-free.

The system cables

Power supply of the conference consoles is via the system cables which also transmit the digital audio and status information.

The software control

The optional software control allows a conference manager to control the entire conference via a PC. In contrast to controlling the conference via the central unit, the software control provides several extra functions:

- **Additional functions for controlling the microphones:**
Via the computer screen, the conference manager can easily monitor which participants have made a request to speak, which participants are currently speaking, etc. All participants can be identified and displayed by name. Individual conference consoles can be directly activated or deactivated by clicking the mouse key.
- **Display of voting results as diagrams:**
The results of votings can be presented graphically and can, for example, be displayed via a connected projector. In addition, it is possible to take voting sessions with chip cards. Chip cards make sure that only those who have a chip card have access to the voting function.
- **Configuration of special conference consoles:**
The conference manager can configure more than one chairman unit as well as VIP units.
- **Interpreter management software:**
This software module allows the conference manager to quickly and easily configure the interpreter booths and interpreter consoles (i.e. assign a language to the A-channel and B-channel of an interpreter

console, choose the operating mode between and within the interpreter booths, etc.).

- Delegate database:

The delegate database allows the conference manager to centrally manage delegate information such as name, organization, etc. During the conference, this information is displayed on the computer screen, allowing the conference manager to identify the participants who are currently speaking or those who wish to make a contribution by name. It is also possible to use the information contained on the chip cards.

The technology used

Both the control and sound transmission of the SDC 8200 conference and interpretation system are fully digital, resulting in excellent audio. The language channels are transmitted within a frequency range of 100 Hz to 14 kHz at 16-bit resolution.

The conference consoles are connected to each other and to the central unit by means of system cables.

The components of the SDC 8200 system in detail

The components described on the following pages are available for the SDC 8200 conference and interpretation system. The components you require depend on the desired size and use of the SDC 8200 system.

Your conference and interpretation system can comprise the following consoles:

- two types of conferences consoles
 - the delegate units for the conference participants
 - the chairman unit for the chairman
- the interpreter consoles

In addition, your conference and interpretation system must comprise:

- at least one central unit

Optionally, you can connect the following components:

- an analog output unit
- a control panel
- a special "ambient sound" conference console



The consoles

Six conference console versions with varying levels of functions as well as an interpreter console are available.



All consoles feature:

- a built-in loudspeaker via which the floor channel is output
- a microphone key  for activating the microphone
- a microphone – if the microphone is active, the red signal light ring and the "Microphone active" LED light up permanently
- a headphone connection with headphone volume control
- voting keys with LEDs (either 3 or 5 voting keys, depending on the console version)

The **chairman units** (SDC 8200 C, SDC 8200 CC and SDC 8200 CV) additionally feature:

- a priority key  for turning off all active delegate units
- a NEXT key  for assigning the "speaking right" to the next participant who has made a request to speak (SDC 8200 C and SDC 8200 CC only).

Conference consoles with channel selection keys (SDC 8200 DC, SDC 8200 CC, SDC 8200 DV and SDC 8200 CV) feature:

- a 2-digit LED channel display for displaying the selected interpretation channel and two channel selection keys (" ▲" and " ▼") for selecting the interpretation channel.

The selected interpretation channel is output via connected headphones.

Conference consoles with display and chip card slot (SDC 8200 CV and SDC 8200 DV) feature:

- a chip card slot for delegate identification
- a dot matrix display (122 x 32 dots) for displaying voting options, voting results and other important information

The interpreter console features:

- special "interpretation" functions
- a muting function (MUTE key)
- tone controls for volume, middle and treble of the headphones and a volume control for the loudspeaker
- a chip card slot

The six conference console versions and the interpreter console are illustrated in detail on the following pages.

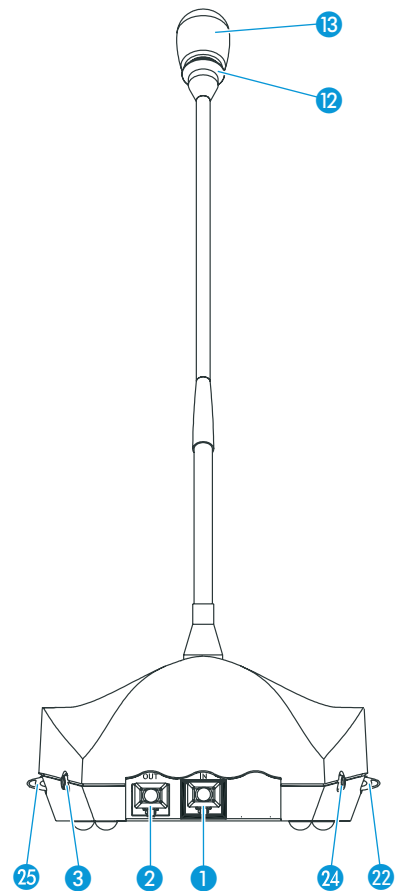
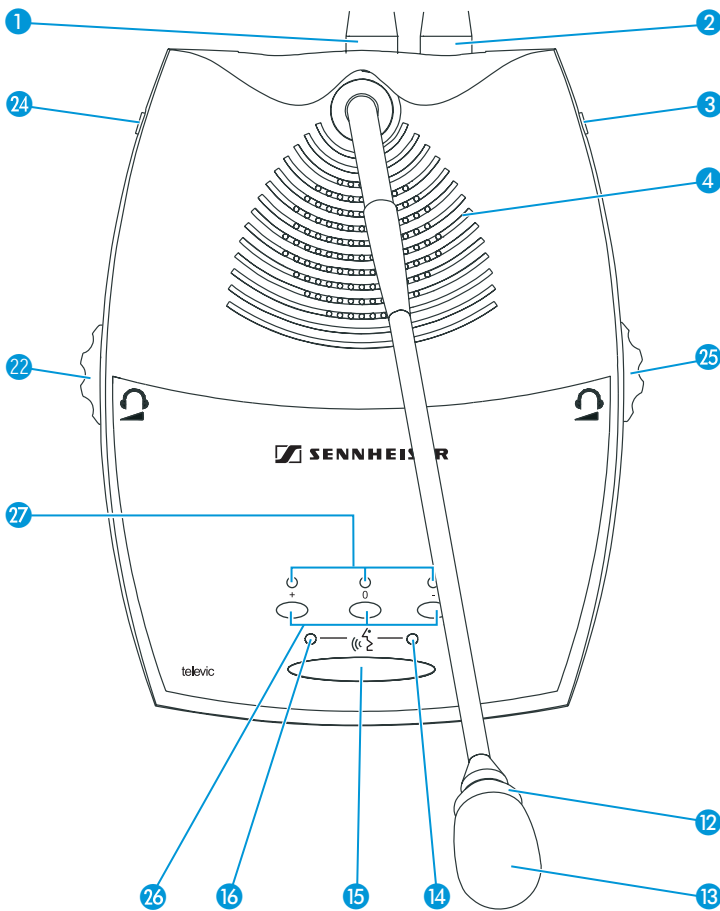

SDC 8200 D conference unit

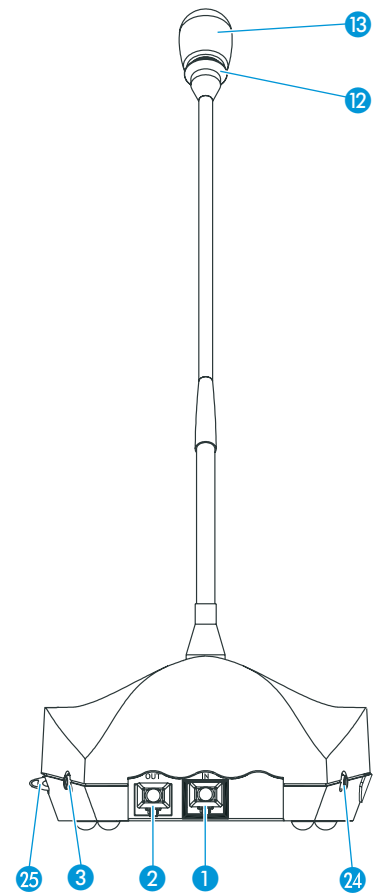
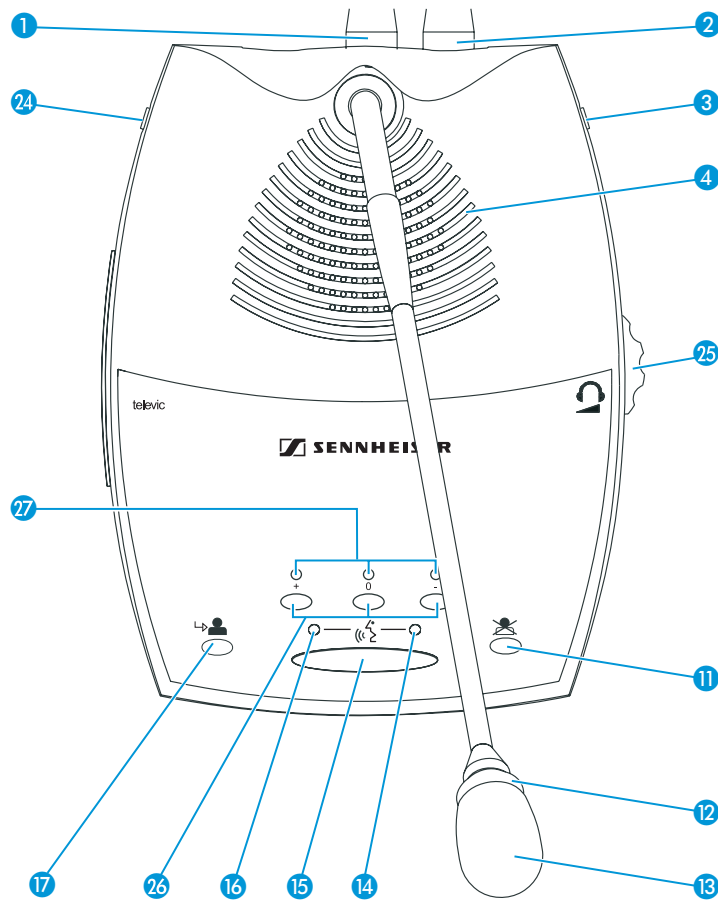

- 1 IN socket (RJ 45)
- 2 OUT socket (RJ 45)
- 3 Right headphone output (3.5 mm mono jack socket)
- 4 Loudspeaker
- 12 Red signal light ring
- 13 Microphone
- 14 "Microphone active" LED
- 15 Microphone key 
- 16 "Request to speak" LED
- 22 Headphone volume control for left headphone output 24
- 24 Left headphone output (3.5 mm mono jack socket)
- 25 Headphone volume control for right headphone output 3
- 26 3 voting keys
- 27 3 voting LEDs

SDC 8200 C chairman unit



- 1 IN socket (RJ 45)
- 2 OUT socket (RJ 45)
- 3 Right headphone output (3.5 mm mono jack socket)
- 4 Loudspeaker
- 11 Priority key 
- 12 Red signal light ring
- 13 Microphone
- 14 "Microphone active" LED
- 15 Microphone key 
- 16 "Request to speak" LED
- 17 NEXT key 
- 24 Left headphone output (3.5 mm mono jack socket)
- 25 Headphone volume control for headphone outputs 3 and 24
- 26 3 voting keys
- 27 3 voting LEDs

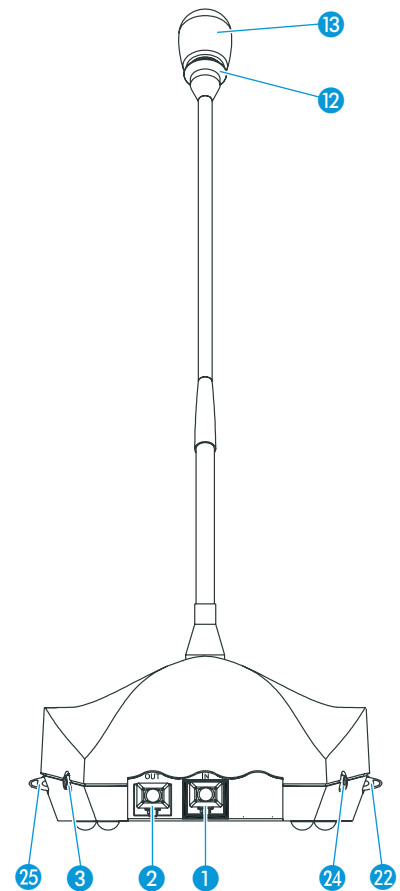
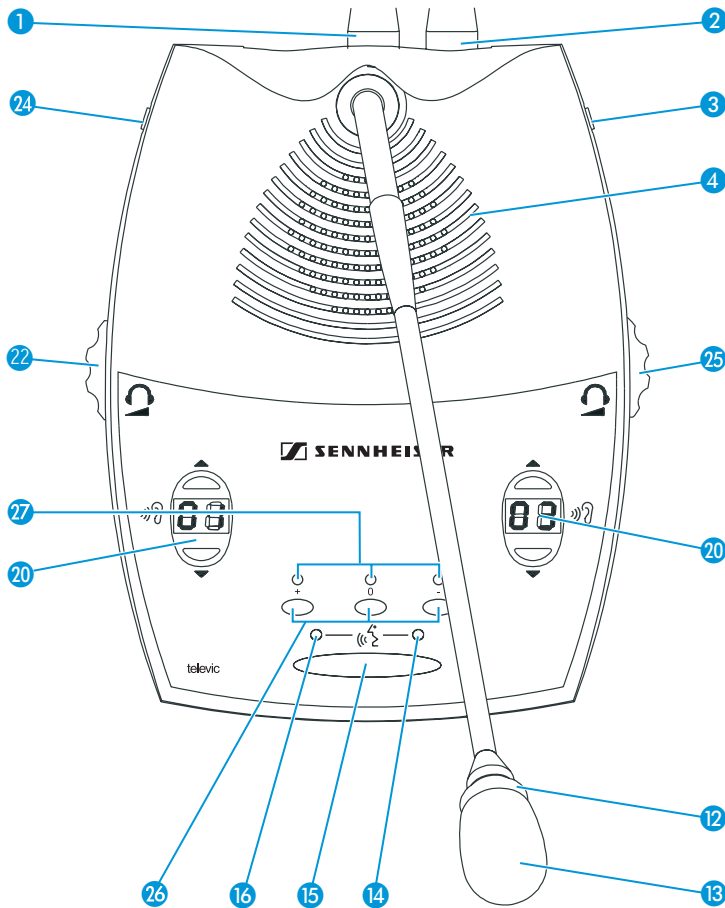

SDC 8200 DC conference unit

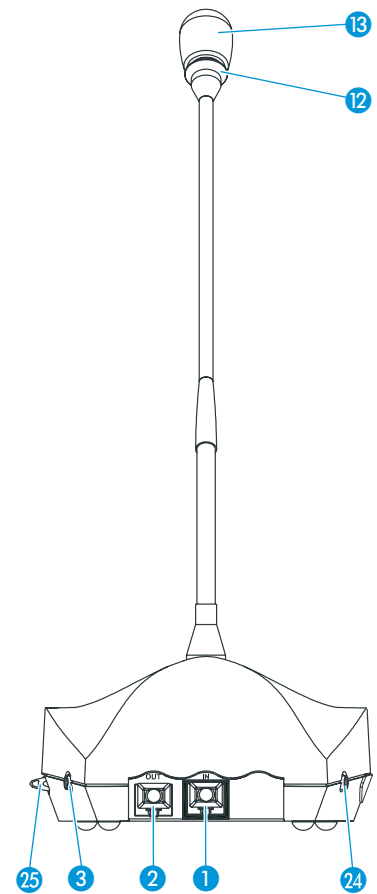
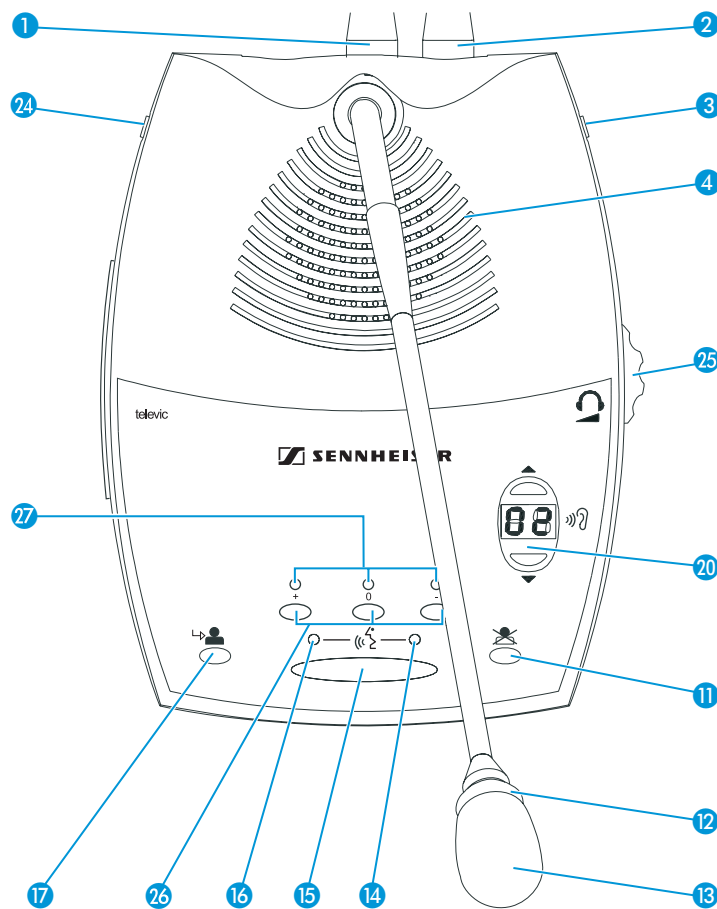

- 1 IN socket (RJ 45)
- 2 OUT socket (RJ 45)
- 3 Right headphone output (3.5 mm mono jack socket)
- 4 Loudspeaker
- 12 Red signal light ring
- 13 Microphone
- 14 "Microphone active" LED
- 15 Microphone key
- 16 "Request to speak" LED
- 20 Channel display with "▲" and "▼" channel selection keys
- 22 Headphone volume control for left headphone output
- 24 Left headphone output (3.5 mm mono jack socket)
- 25 Headphone volume control for right headphone output
- 26 3 voting keys
- 27 3 voting LEDs

SDC 8200 CC chairman unit



- 1 IN socket (RJ 45)
- 2 OUT socket (RJ 45)
- 3 Right headphone output (3.5 mm mono jack socket)
- 4 Loudspeaker
- 11 Priority key 
- 12 Red signal light ring
- 13 Microphone
- 14 "Microphone active" LED
- 15 Microphone key 
- 16 "Request to speak" LED
- 17 NEXT key 
- 20 Channel display with "▲" and "▼" channel selection keys
- 24 Left headphone output (3.5 mm mono jack socket)
- 25 Headphone volume control for headphone outputs 3 and 24
- 26 3 voting keys
- 27 3 voting LEDs

SDC 8200 DV conference unit

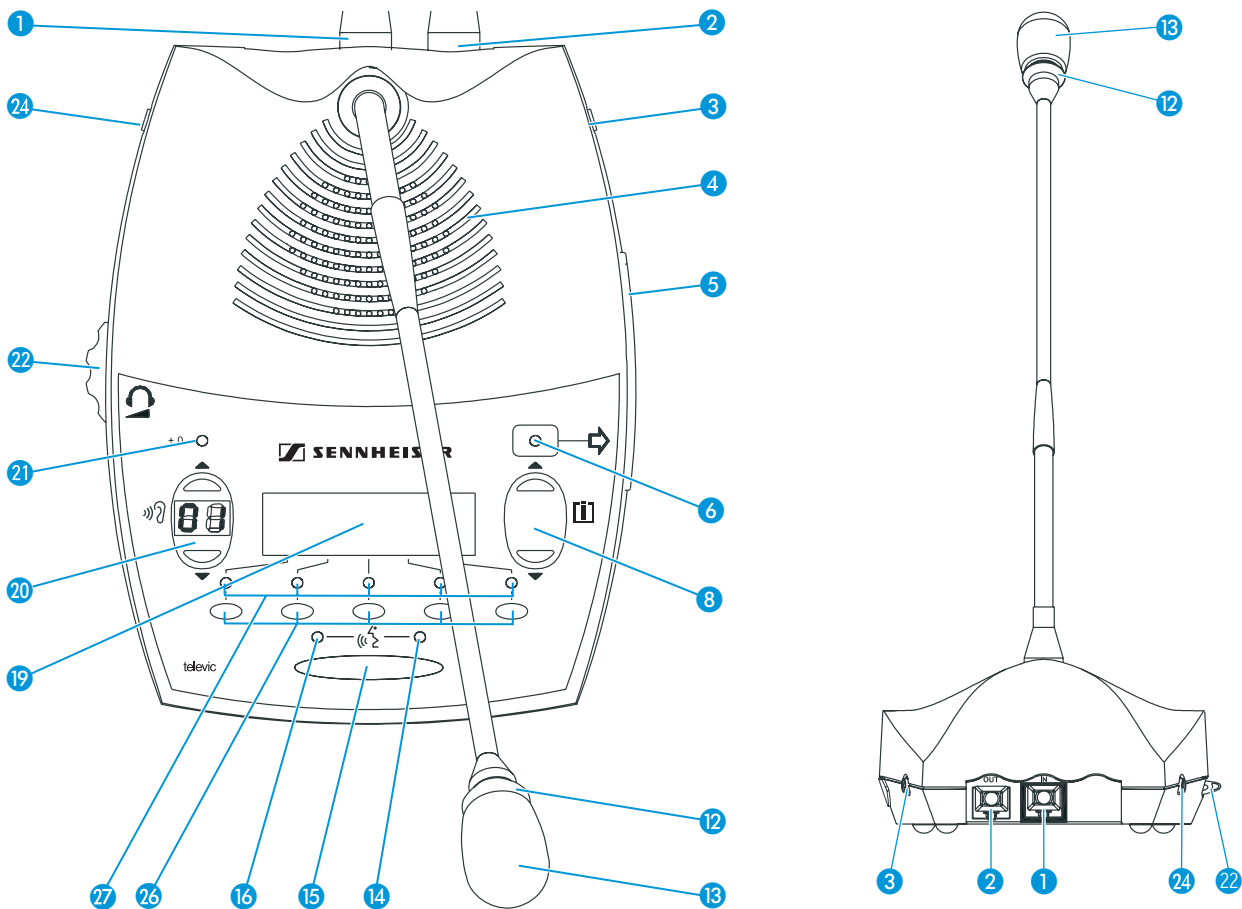

- 1 IN socket (RJ 45)
- 2 OUT socket (RJ 45)
- 3 Right headphone output (3.5 mm mono jack socket)
- 4 Loudspeaker
- 5 Chip card slot
- 6 "Chip card" LED
- 8 "▲" and "▼" menu selection keys
- 12 Red signal light ring
- 13 Microphone
- 14 "Microphone active" LED
- 15 Microphone key 
- 16 "Request to speak" LED
- 19 Dot matrix display
- 20 Channel display with "▲" and "▼" channel selection keys
- 21 VOTE LED
- 22 Headphone volume control for headphone outputs 3 and 24
- 24 Left headphone output (3.5 mm mono jack socket)
- 26 5 voting keys
- 27 5 voting LEDs

SDC 8200 CV chairman unit

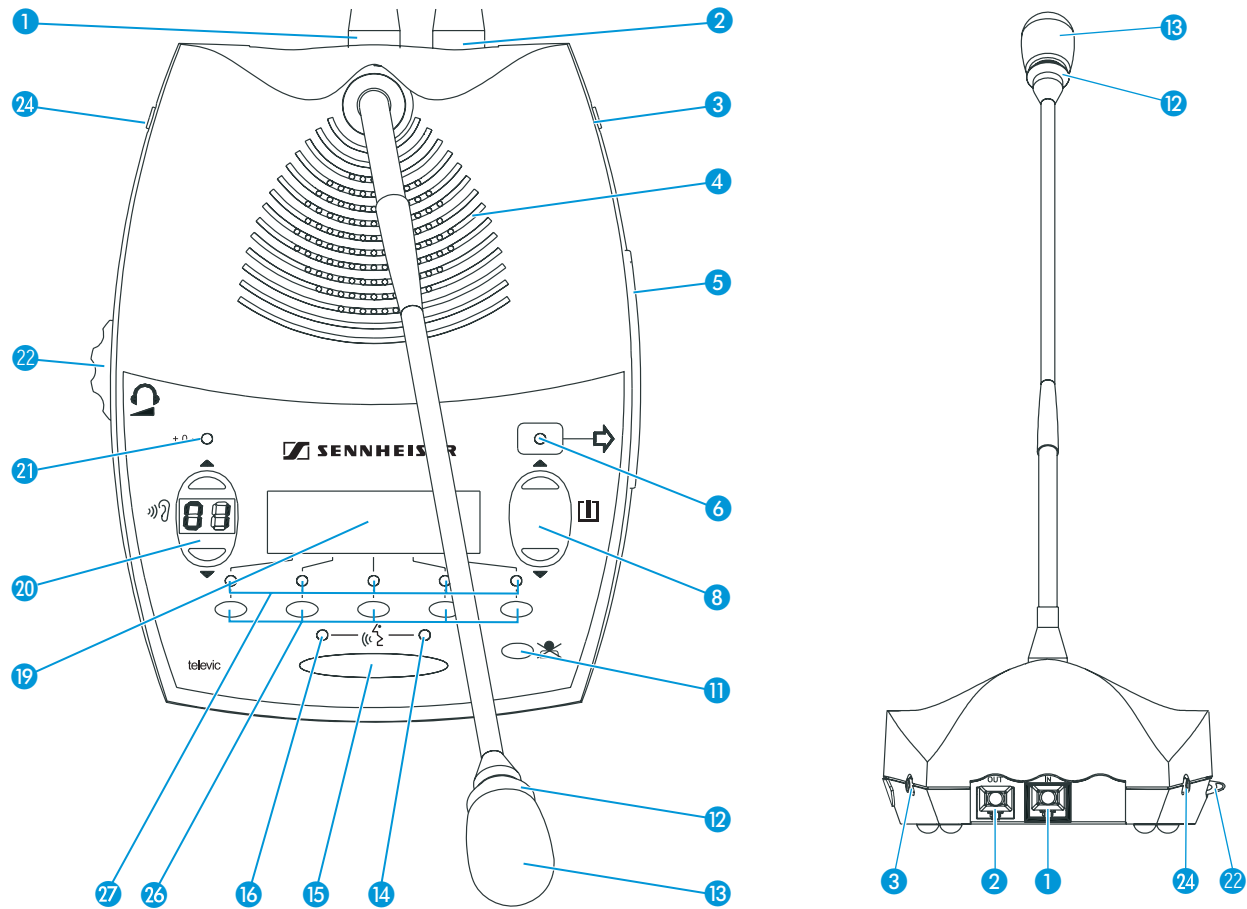

- 1 IN socket (RJ 45)
- 2 OUT socket (RJ 25)
- 3 Right headphone output (3.5 mm mono jack socket)
- 4 Loudspeaker
- 5 Chip card slot
- 6 "Chip card" LED
- 8 "▲" and "▼" menu selection keys
- 11 Priority key
- 12 Red signal light ring
- 13 Microphone
- 14 "Microphone active" LED
- 15 Microphone key
- 16 "Request to speak" LED
- 19 Dot matrix display
- 20 Channel display with "▲" and "▼" channel selection keys
- 21 VOTE LED
- 22 Headphone volume control for headphone outputs 3 and 24
- 24 Left headphone output (3.5 mm mono jack socket)
- 26 5 voting keys
- 27 5 voting LEDs

SDC 8200 ID interpreter console

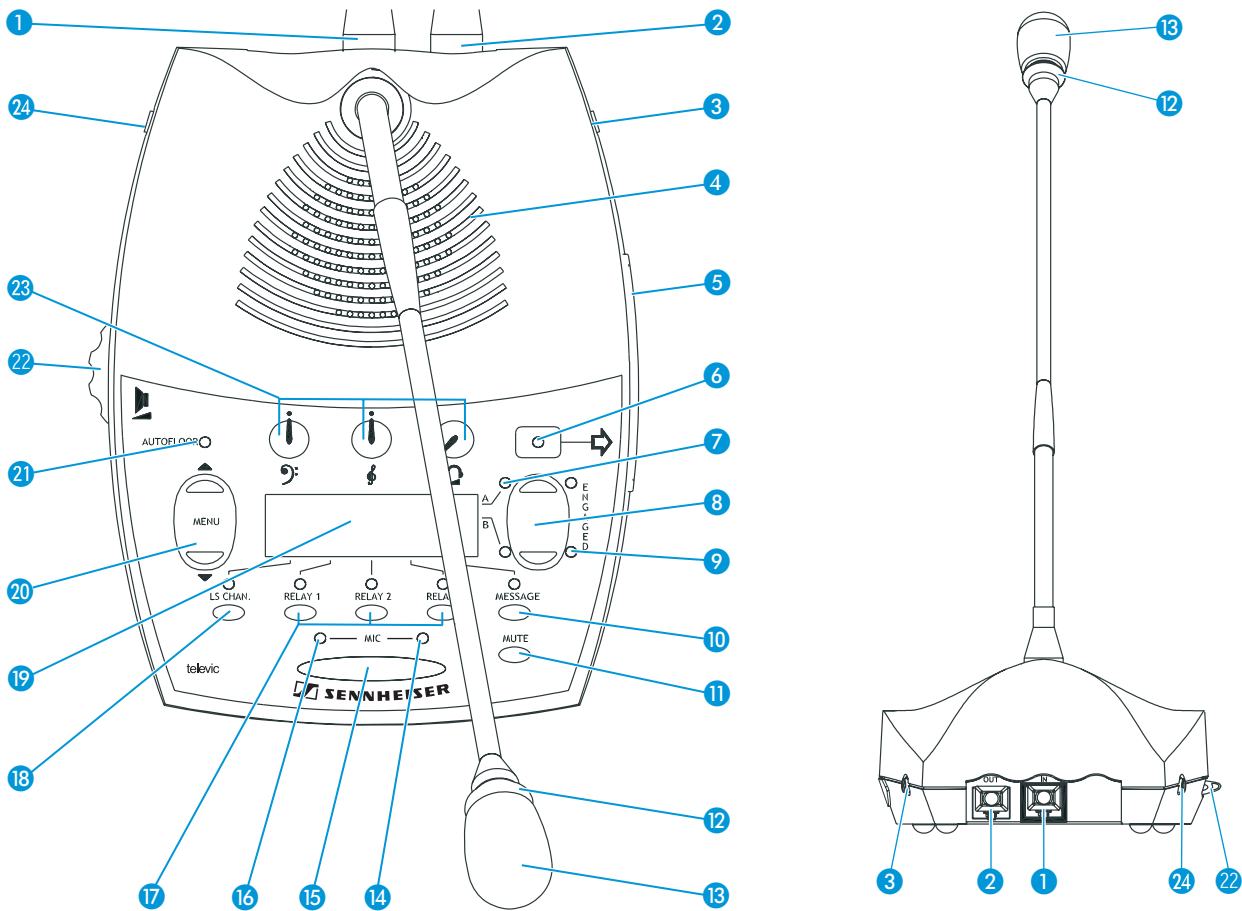

- 1 IN socket (RJ 45)
- 2 OUT socket (RJ 45)
- 3 Right headphone output (3.5 mm mono jack socket)
- 4 Loudspeaker
- 5 Chip card slot
- 6 "Chip card" LED
- 7 "Channel" LEDs "A" and "B"
- 8 Channel keys "A" and "B"
- 9 ENGAGED LEDs "A" and "B"
- 10 MESSAGE key
- 11 MUTE key
- 12 Red signal light ring
- 13 Microphone
- 14 "Microphone active" LED
- 15 MIC key
- 16 "Initialized" LED
- 17 RELAY 1 to RELAY 3 keys
- 18 LS CHAN. key
- 19 Dot matrix display
- 20 "MENU ▲" and "MENU ▼" menu selection keys
- 21 AUTOFLOOR LED
- 22 Loudspeaker volume control
- 23 Tone controls (volume, middle and treble) for headphone outputs 3 and 24
- 24 Left headphone output (3.5 mm mono jack socket)
- 28 Headset output (3.5 mm stereo jack socket)

The SDC 8200 CU central unit

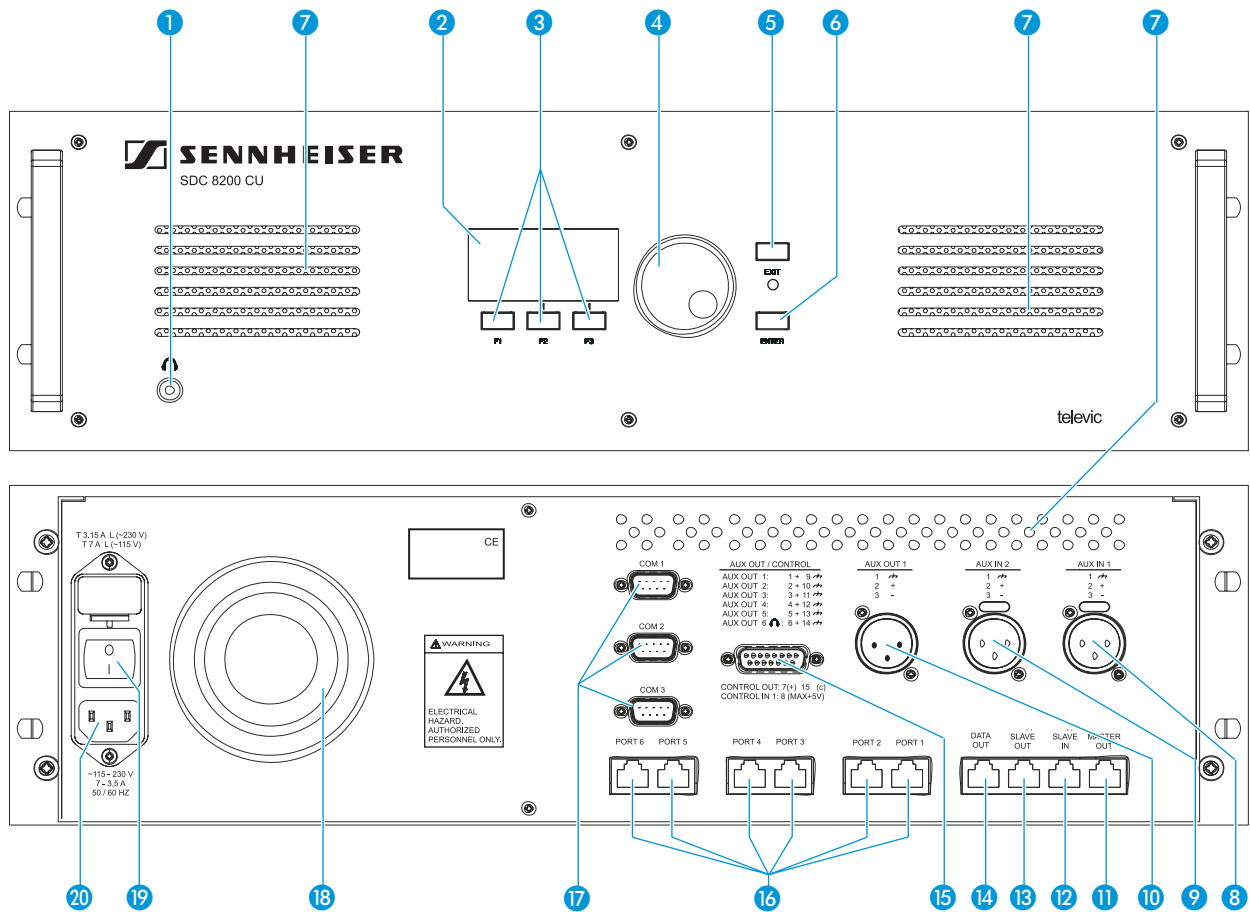

- | | |
|--|--|
| <ul style="list-style-type: none"> 1 Headphone output (3.5 mm mono jack socket) 2 Display 3 F1 to F3 function keys 4 Jog wheel for selecting the menus 5 EXIT key 6 ENTER key 7 Air vents 8 AUX IN 1 audio input (XLR-3F) 9 AUX IN 2 audio input (XLR-3F) 10 AUX OUT 1 audio output (XLR-3M) 11 MASTER OUT socket (RJ 45) | <ul style="list-style-type: none"> 12 SLAVE IN socket (RJ 45) 13 SLAVE OUT socket (RJ 45) 14 DATA OUT socket (RJ 45) 15 AUX OUT audio outputs 1 to 6 (15-pole sub-D socket) 16 PORT 1 to PORT 6 sockets (RJ 45) for connecting cable strings 17 COM 1 to COM 3 serial interfaces 18 Fan for integrated power supply 19 POWER switch 20 Socket for mains cable |
|--|--|

The SDC 8200 CU-M central unit

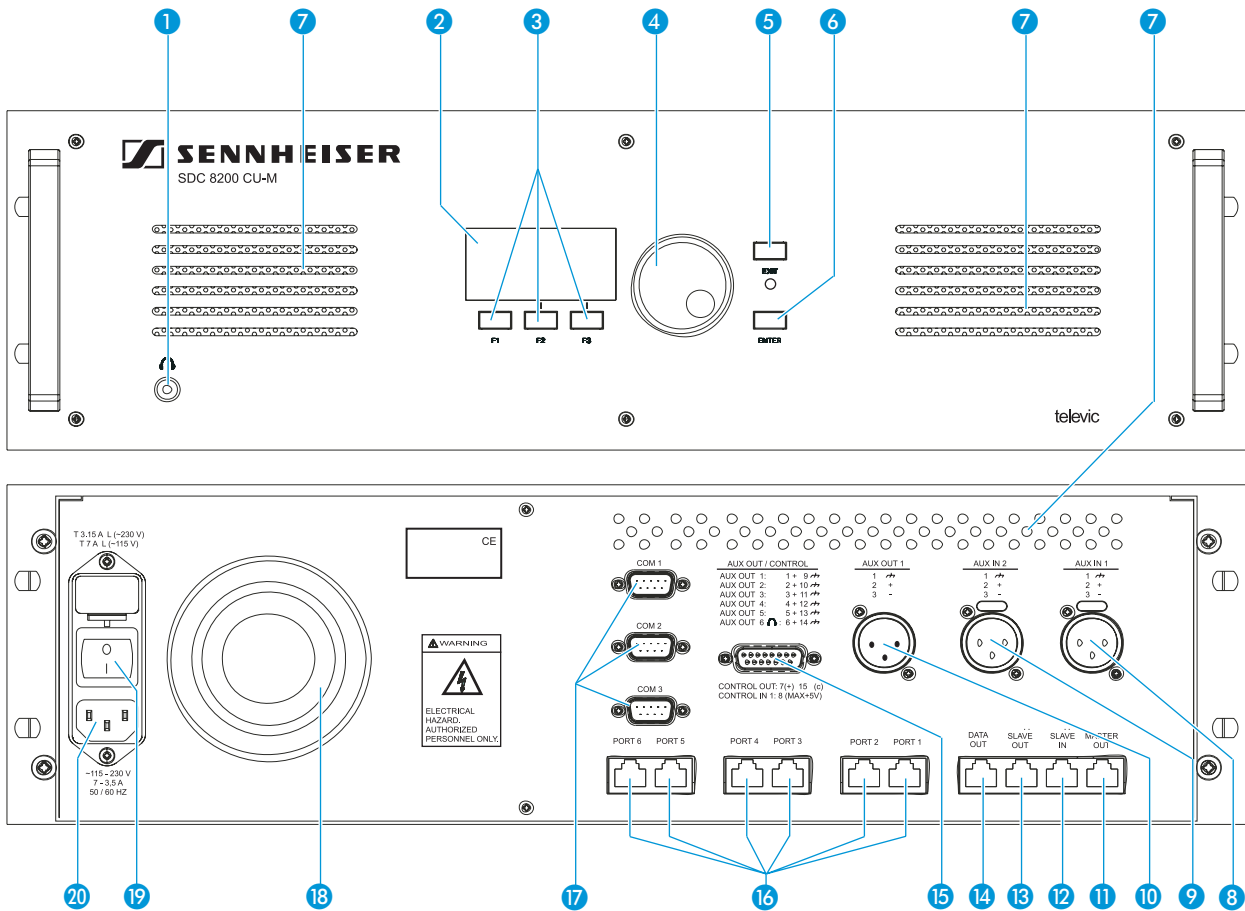

- | | |
|--|--|
| 1 Headphone output (3.5 mm mono jack socket) | 12 SLAVE IN socket (RJ 45) (not connected) |
| 2 Display | 13 SLAVE OUT socket (RJ 45) (not connected) |
| 3 F1 to F3 function keys | 14 DATA OUT socket (RJ 45) (not connected) |
| 4 Jog wheel for selecting the menus | 15 AUX OUT audio outputs 1 to 6 (15-pole sub-D socket) |
| 5 EXIT key | 16 PORT 1 to PORT 6 sockets (RJ 45) for connecting cable strings |
| 6 ENTER key | 17 COM 1 to COM 3 serial interfaces |
| 7 Air vents | 18 Fan for integrated power supply |
| 8 AUX IN 1 audio input (XLR-3F) | 19 POWER switch |
| 9 AUX IN 2 audio input (XLR-3F) | 20 Socket for mains cable |
| 10 AUX OUT 1 audio output (XLR-3M) | |
| 11 MASTER OUT socket (RJ 45) (not connected) | |

The SDC 8200 AO analog output unit (optional)

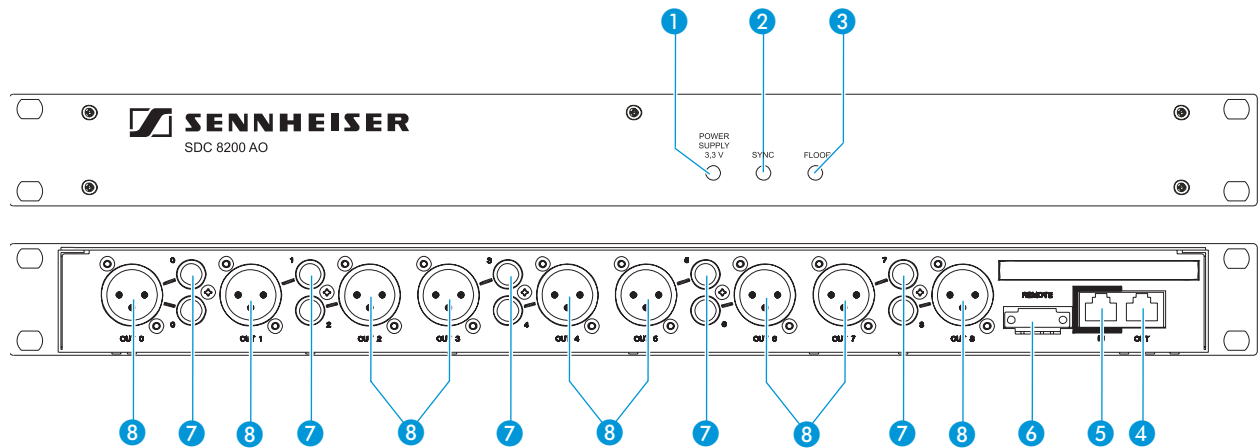

- 1 POWER SUPPLY LED (lights up, if power is supplied to the SDC 8200 AO)
- 2 SYNC. LED (lights up, if the data exchange between the central unit and the SDC 8200 AO functions correctly)
- 3 FLOOR LED (lights up, if the floor channel is being used)
- 4 DIGITAL BUS OUT socket (RJ 45) for connecting an additional analog output unit
- 5 DIGITAL BUS IN socket (RJ 45) for connection of the central unit
- 6 Phoenix connector (e.g. for turning on/off a recording unit via a voltage-free contact)
- 7 Phono socket (unbalanced), 10x
- 8 XLR-3M audio output (transformer balanced), 9x

The system cables

The system cables required for your planned conference and interpretation system must be ordered separately. The system cables are available with lengths of 2 m, 3 m, 5 m, 10 m, 20 m and 50 m.

Via the system cables, you can:

- interconnect the conference and interpreter consoles,
- interconnect up to 10 central units for setting up a large conference and interpretation system,
- connect an SDC 8200 AO analog output unit to the central unit,
- connect cable strings to the central unit.

The system cables must meet the following specifications:

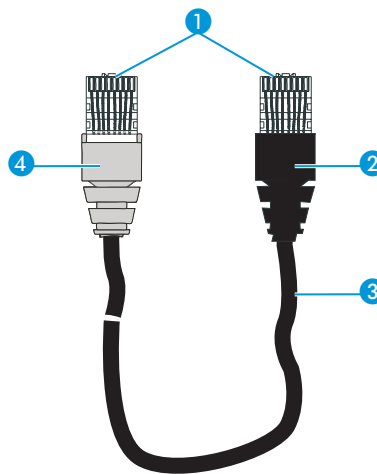

- 1 Shielded RJ 45 modular plug, cat 5(e)
- 2 Black cable booth with clip protector
- 3 Round STP cable, cat 5(e), 24AWG
- 4 Grey cable booth with clip protector

Operating the components of the SDC 8200 system

Depending on the type of **delegate unit**, conference participants can:

- listen, take the floor or make a request to speak,
- receive simultaneous interpretation,
- participate in voting sessions.

In addition to the functions and features of the delegate units, the **chairman unit** allows to:

- start a voting session (SDC 8200 CV only),
- mute all active delegate units (priority function).

The **interpreter consoles** are exclusively used by the interpreters.

The **central unit** is operated by the conference manager – either directly or via an optional PC with software control.

Operating the delegate units

Taking the floor / Making a request to speak

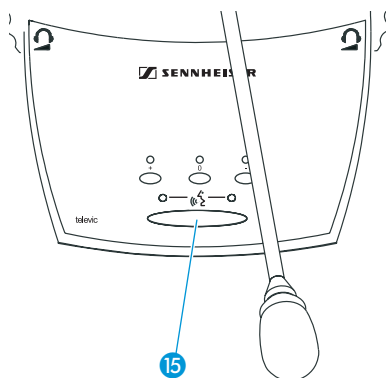

In order to take the floor or make a request to speak, you have to press the microphone key (⌘ 15). Depending on the conference mode chosen (1. to 10., see following section), you can either take the floor immediately or you have to wait until your microphone is turned on.

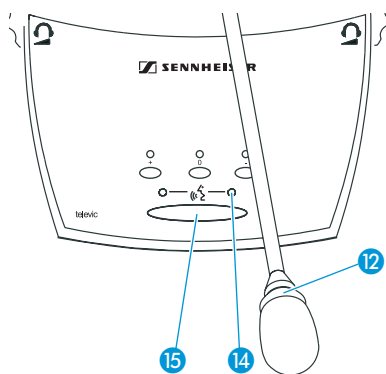

1. In "Direct Access" mode:

- ▶ Press the microphone key (⌘ 15).

If the speaker limit has not yet been reached, you can take the floor immediately. The red signal light ring (12) and the "Microphone active" LED (14) on your console light up permanently, indicating that you can now take the floor.

If the speaker limit has been reached, you have to wait until one of the current speakers has finished speaking and passes on the "speaking right". You then have to press the microphone key (⌘ 15) again.

2. In "Fifo" mode:

In this mode, the speaker limit is 1.

- ▶ Press the microphone key  15.

Pressing the microphone key on your console will automatically turn off the microphone of the previous speaker ("first-in-first-out" principle). The red signal light ring 12 and the "Microphone active" LED 14 on your console light up permanently, indicating that you can now take the floor.

Note!

The chairman units and VIP units remain unaffectedly active.

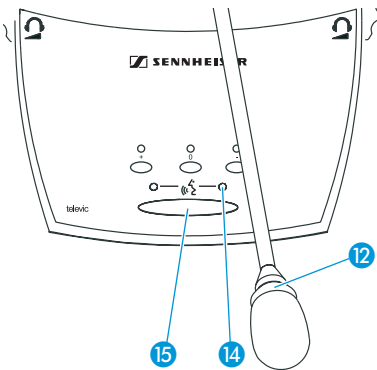

3. In "Group 1" mode:

In this mode, the speaker limit is 1.

- ▶ Press the microphone key  15.

If no other participant is currently speaking, you can take the floor immediately. The red signal light ring 12 and the "Microphone active" LED 14 on your console light up permanently, indicating that you can now take the floor.

If the speaker limit has been reached, you will join the waiting list and the green "Request to speak" LED 16 on your console starts flashing. As soon as the active microphone is turned off, the microphone of the first participant from the request-to-speak list is turned on, and so on. When it is your turn to speak, the red signal light ring 12 and the "Microphone active" LED 14 on your console light up permanently.

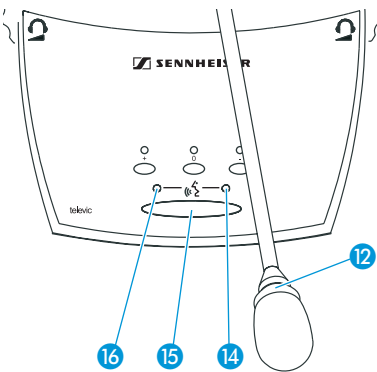

4. In "Group 2" mode:

In this mode, the speaker limit is 2.

- ▶ Press the microphone key  15.

If the speaker limit has not yet been reached, you can take the floor immediately. The red signal light ring 12 and the "Microphone active" LED 14 on your console light up permanently, indicating that you can now take the floor.

If the speaker limit has been reached, you will join the waiting list and the green "Request to speak" LED 16 on your console starts flashing. As soon as one of the active microphones is turned off, the microphone of the first participant from the request-to-speak list is turned on, and so on.

When it is your turn to speak, the red signal light ring 12 and the "Microphone active" LED 14 on your console light up permanently.

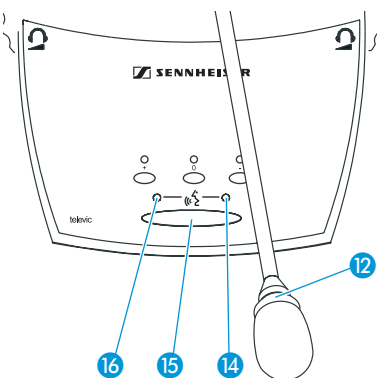

5. In "Group 3" mode:

In this mode, the speaker limit is 3.

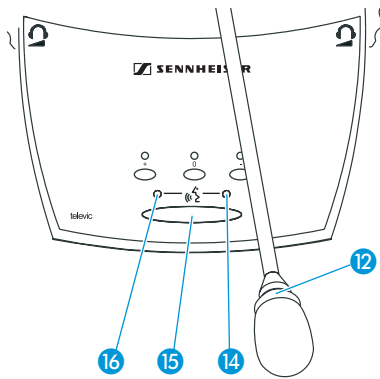

- ▶ Press the microphone key (15).

If the speaker limit has not yet been reached, you can take the floor immediately. The red signal light ring (12) and the "Microphone active" LED (14) on your console light up permanently, indicating that you can now take the floor.

If the speaker limit has been reached, you will join the waiting list and the green "Request to speak" LED (16) on your console starts flashing. As soon as one of the active microphones is turned off, the microphone of the first participant from the request-to-speak list is turned on, and so on.

When it is your turn to speak, the red signal light ring (12) and the "Microphone active" LED (14) on your console light up permanently.

6. In "Group 4" mode:

In this mode, the speaker limit is 4.

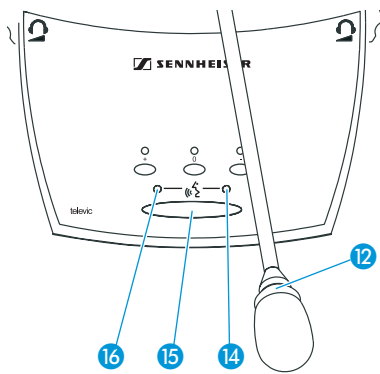

- ▶ Press the microphone key (15).

If the speaker limit has not yet been reached, you can take the floor immediately. The red signal light ring (12) and the "Microphone active" LED (14) on your console light up permanently, indicating that you can now take the floor.

If the speaker limit has been reached, you will join the waiting list and the green "Request to speak" LED (16) on your console starts flashing. As soon as one of the active microphones is turned off, the microphone of the first participant from the request-to-speak list is turned on, and so on.

When it is your turn to speak, the red signal light ring (12) and the "Microphone active" LED (14) on your console light up permanently.

7. In "Override" mode:

In this mode, the speaker limit is variable between 1 and 15.

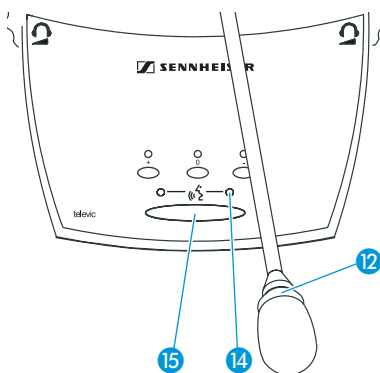

- ▶ Press the microphone key (15).

Pressing the microphone key on your console will automatically turn off the microphone which is active for the longest time. The red signal light ring (12) and the "Microphone active" LED (14) on your console light up permanently, indicating that you can now take the floor.

Note!

The chairman units and VIP units remain unaffectedly active.

8. In "No request" mode:

For this mode to function, the SDC 8200 system must be PC controlled.

In "No request" mode, you have to "apply" for a comment and wait until the conference manager turns on your microphone. The conference manager has total control of the microphones.

Note!

You cannot "apply" for a comment by pressing the microphone key (15).

- ▶ Signal your intention to take the floor e.g. by raising your hand or giving another sign.

The conference manager can either assign you the “speaking right” by turning on your microphone or ignore your request to speak.

When the conference manager turns on your microphone, the red signal light ring 12 and the “Microphone active” LED 14 on your console light up permanently. When the conference manager withdraws the “speaking right” from you, the red signal light ring 12 and the “Microphone active” LED 14 on your console go off.

9. In “With request” mode:

In this mode, the SDC 8200 system can be controlled either by the chairman or via the PC. You can cancel your request to speak.

The chairman can use the NEXT key ↵ (SDC 8200 C and SDC 8200 CC) or the menu selection keys [M] (SDC 8200 CV) for assigning the “speaking right” in the order of application.

If the SDC 8200 system is PC controlled, the “speaking right” can be assigned independently of the order of application.

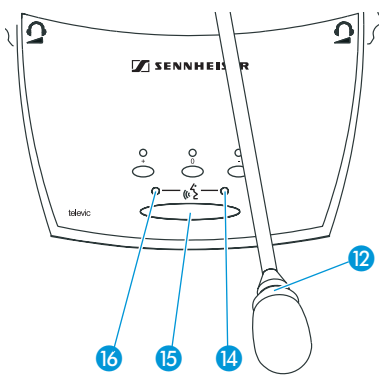

- ▶ Press the microphone key ⌘ (15) to “apply” for a comment.

The green “Request to speak” LED 16 on your console starts flashing.

The chairman or the conference manager can either assign you the “speaking right” by turning on your microphone or ignore your request to speak.

When the chairman or the conference manager turns on your microphone, the red signal light ring 12 and the “Microphone active” LED 14 on your console light up permanently and the green “Request to speak” LED goes off. When the chairman or the conference manager withdraws the “speaking right” from you, the red signal light ring 12 and the “Microphone active” LED 14 on your console go off.

Note!

You can cancel your request to speak by pressing the microphone key ⌘ (15) once more.

10. In “With Req. No clear” mode:

In this mode, the SDC 8200 system can be controlled either by the chairman or via the PC. You **cannot** cancel your request to speak.

The chairman can use the NEXT key ↵ (SDC 8200 C and SDC 8200 CC) or the menu selection keys [M] (SDC 8200 CV) for assigning the “speaking right” in the order of application.

If the SDC 8200 system is PC controlled, the “speaking right” can be assigned independently of the order of application.

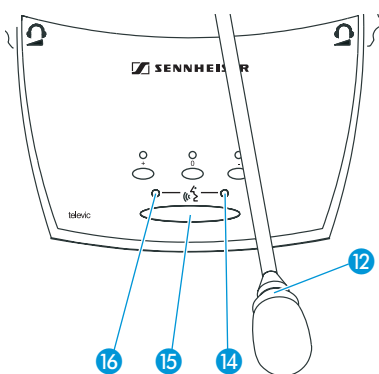

- ▶ Press the microphone key ⌘ (15) to “apply” for a comment.

The green “Request to speak” LED 16 on your console starts flashing.

The chairman or the conference manager can either assign you the “speaking right” by turning on your microphone or ignore your request to speak.

When the chairman or the conference manager turns on your microphone, the red signal light ring 12 and the “Microphone active” LED 14 on your console light up permanently and the green “Request to

“speak” LED goes off. When the chairman or the conference manager withdraws the “speaking right” from you, the red signal light ring 12 and the “Microphone active” LED 14 on your console go off.

Note!

You **cannot** cancel your request to speak by pressing the microphone key  once more!

Turning off the microphone / Cancelling a request to speak

To turn off the microphone when you have finished speaking or to cancel a request to speak:

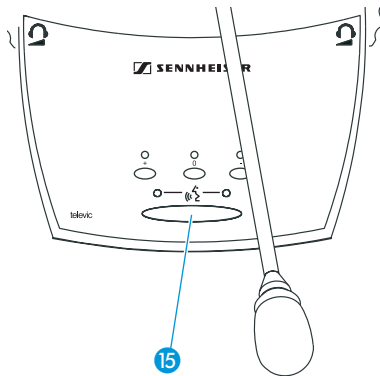

- ▶ Press the microphone key  15 once more. The red signal light ring 12 and the “Microphone active” LED 14 on your console go off.

Adjusting the volume of the headphones connected to a conference console

With conference consoles which feature two headphone outputs but only one volume control (SDC 8200 C, SDC 8200 CC, SDC 8200 DV and SDC 8200 CV), the volume control adjusts the volume for both connected headphones.

The volume is steplessly adjustable and the volume control has no stop. At each system start-up, the volume is automatically reset to a medium level.

Attention! High Volume!

This is a professional conference system. Commercial use is subject to the rules and regulations of the trade association responsible. Sennheiser, as the manufacturer, is therefore obliged to expressly point out possible health risks arising from use.

This system is capable of producing sound pressure exceeding 85 dB(A). 85 dB(A) is the sound pressure corresponding to the maximum permissible volume which is by law (in some countries) allowed to affect your hearing for the duration of a working day. It is used as a basis according to the specifications of industrial medicine. Higher volumes or longer durations can damage your hearing. At higher volumes, the duration must be shortened in order to prevent damage. The following are sure signs that you have been subjected to excessive noise for too long a time:

- You can hear ringing or whistling sounds in your ears.
- You have the impression (even for a short time only) that you can no longer hear high notes.

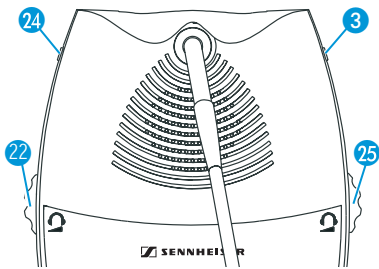

To adjust the volume of the headphones connected to your conference console:

- ▶ Connect Sennheiser mono headphones to the 3.5 mm mono jack socket (3 and/or 24).
- ▶ First, use the headphone volume control (22 and/or 25) to reduce the headphone volume to the minimum.
- ▶ Put on the headphones and slowly set the volume to a medium level.

Selecting an interpretation channel

If your console is equipped with channel selection keys (SDC 8200 DC, SDC 8200 CC, SDC 8200 DV and SDC 8200 CV), you can choose between the floor channel and the offered interpretation channels.

To select an interpretation channel:

- ▶ Connect Sennheiser mono headphones to your conference console.
- ▶ Press the "») ▲" or "») ▼" channel selection key 20. The selected interpretation channel is output via your headphones.

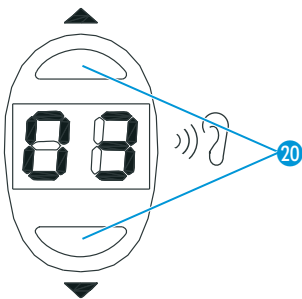

Voting

You can participate in voting sessions which have to be started by the chairman.

There are two voting modes ("Vote 1 of 3" and "Vote 1 of 5") which offer different voting options.

Vote 1 of 3

In "Vote 1 of 3" mode, you can vote "Yes" (+) or "No" (-) or abstain (0):

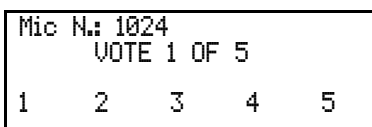

- ▶ To cast your vote, press the corresponding key 26.
 - +: Yes
 - : No
 - 0: Abstention
 Your vote is counted. If voting is not secret, the corresponding voting LED 27 lights up.

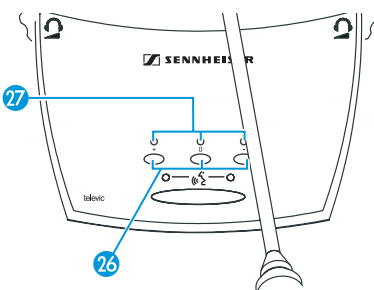

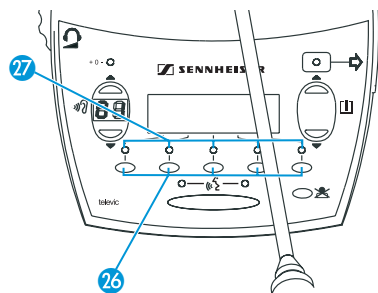
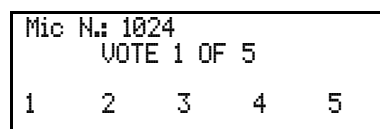

Vote 1 of 5

In “Vote 1 of 5” mode, you have the choice of five options (1 to 5):

- ▶ To cast your vote, press the corresponding key **26** below the display. Your vote is counted. If voting is not secret, the corresponding voting LED **27** lights up. After the voting session, the result of the vote is shown on the displays of the consoles.

Caution!

If your conference system comprises conference consoles with 3 and 5 voting keys and you carry out a voting in “Vote 1 of 5” mode, this will falsify the voting results. In this case, always choose the “Vote 1 of 3” mode.

Using the chip card slot of a conference console

If the conference consoles feature a chip card slot and if your system is PC controlled, you can:

- make sure that only authorized delegates can participate in voting sessions.
- take roll-call votes, i.e. you can see the name of each conference participant and his or her voting position.

Operating the VIP units

VIP units are special delegate units which have the “rights” of a chairman unit.

- With a VIP unit, you can take the floor at any time, regardless of the conference mode and without first having to be assigned the “speaking right”.
- If the chairperson presses the priority key , all active conference consoles – except for the VIP units – are turned off. The chairperson cannot withdraw the “speaking right” from you.
- The VIP units are operated in the same way as the delegate units.

Note!

You can configure VIP units either via the central unit’s operating menu (see “Configuring additional VIP units (VIP)” on page 92) or via the software control of the conference system.

Operating the chairman unit

Turning all active conference consoles off (priority)

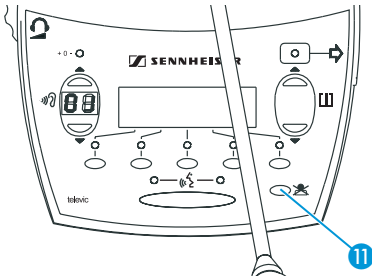

All chairman units are equipped with a priority function, allowing the chairman to stop a discussion any time. By using this function, all active conference consoles are turned off.

To use the priority function:

- ▶ Press the priority key . All active conference consoles – except for the VIP units – are turned off.

Starting a voting session

A voting session can be started by either the chairman or – provided that a PC with software control is connected to the central unit – the conference manager.

With the SDC 8200 CV chairman unit with voting function, you can start a voting session as follows:

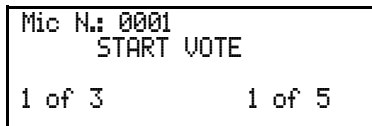

- ▶ Choose one of the two voting modes “1 of 3” or “1 of 5” by pressing the corresponding key below the display.

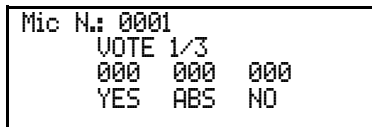

Caution!

If your conference system comprises conference consoles with 3 and 5 voting keys and you carry out a voting in “Vote 1 of 5” mode, this will falsify the voting results. In this case, always choose the “Vote 1 of 3” mode.

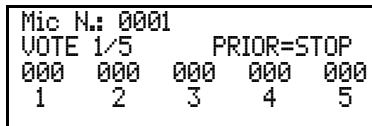

Depending on the voting mode chosen, your display looks like one of the two displays shown on the left.



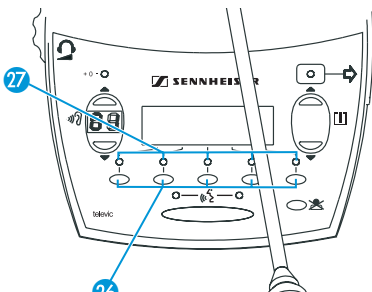

- ▶ Ask the participants to cast their vote.
- ▶ Cast your own vote by pressing one of the keys .
 - With the SDC 8200 C and SDC 8200 CC conference consoles:
 - +: Yes
 - : No
 - 0: Abstention
 - With the SDC 8200 CV conference console:
 - “1” to “5”: depending on the respective assignment shown on the display
- If voting is not secret, the corresponding voting LED  lights up.
- ▶ Make sure that all conference participants have cast their vote.
- ▶ To stop the voting session:



```
Mic N.: 0001
VOTE 1/3
245 002 150
YES ABS NO
```

```
Mic N.: 0001
RESULTS          PRIOR=END
032 041 009 015 625
1   2   3   4   5
```

- Stop "Vote 1/3" by pressing the key below "STOP".
The voting result is shown on the consoles with display.
Press the key below "END" to clear the voting result from the displays.
- Stop "Vote 1/5" by pressing the priority key 
The voting result is shown on the consoles with display.
Press the priority key  again to clear the voting result from the displays.

Assigning a participant the "speaking right"

If – in "With Request" or "With Req. No Clear" mode – a participant presses the microphone key  on his console, he makes a request to speak. All participants who have made a request to speak will join a request-to-speak list.

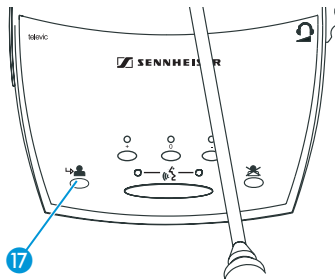

To assign the first participant from the request-to-speak list the "speaking right" using the SDC 8200 C or SDC 8200 CC chairman unit:

- ▶ Press the NEXT key  17.
The next participant from the request-to-speak list is assigned the "speaking right".

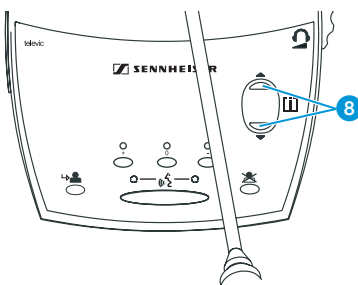

To assign the first participant from the request-to-speak list the "speaking right" using the SDC 8200 CV chairman unit:

- ▶ Press the „[1]▲“ 8 und „[1]▼“ 8 menu selection key.
The first three consoles from which a request to speak has been made are shown on the displays of all conference consoles. If you do not use chip cards, the microphone numbers are displayed; if you use chip cards, the delegate names stored on the chip cards are displayed (see also next section). In addition, "NEXT" is shown in the lower left corner of the display.

```
MIC N.: 0001
REQUEST: MIC N.0657
          MIC N.0421
NEXT     MIC N.0010
```

```
MIC N.: 0001
REQUEST: ARCHER
          VAN BUUREN
NEXT     TAKAHASHI
```



- ▶ On the left-hand side below the display, press the key which is assigned to the text "NEXT".
The next participant from the request-to-speak list is assigned the "speaking right".

Showing the request-to-speak list on the displays of the conference consoles

If – in "With Request" or "With Req. No Clear" mode – a participant presses the microphone key  on his console, he makes a request to speak. All participants who have made a request to speak will join a request-to-speak list.

If the SDC 8200 CV chairman unit is configured so that the request-to-speak list is shown on the display, this request-to-speak list is also shown on all SDC 8200 DV conference consoles.

To configure the SDC 8200 CV chairman unit so that the request-to-speak list is shown on the displays of all conference consoles:

- ▶ On the SDC 8200 CV chairman unit, press the “ ▲” or “ ▼” menu selection key.

The request-to-speak list is shown on the displays of all SDC 8200 DV and SDC 8200 CV conference consoles. The microphone numbers of the consoles from which a request to speak has been made are not shown on the displays of the SDC 8200 CV conference consoles.

Operating the interpreter consoles

Adjusting the volume and the middle and treble response of the headphones connected to the interpreter console

If you have connected two headphones to the interpreter console, the volume control adjusts the volume for both headphones. At each system start-up, the volume is automatically reset to a medium level.

Attention! High Volume!

This is a professional conference system. Commercial use is subject to the rules and regulations of the trade association responsible. Sennheiser, as the manufacturer, is therefore obliged to expressly point out possible health risks arising from use.

This system is capable of producing sound pressure exceeding 85 dB(A). 85 dB(A) is the sound pressure corresponding to the maximum permissible volume which is by law (in some countries) allowed to affect your hearing for the duration of a working day. It is used as a basis according to the specifications of industrial medicine. Higher volumes or longer durations can damage your hearing. At higher volumes, the duration must be shortened in order to prevent damage. The following are sure signs that you have been subjected to excessive noise for too long a time:

- You can hear ringing or whistling sounds in your ears.
- You have the impression (even for a short time only) that you can no longer hear high notes.

To adjust the volume and the middle and treble response of the headphones connected to your interpreter console:

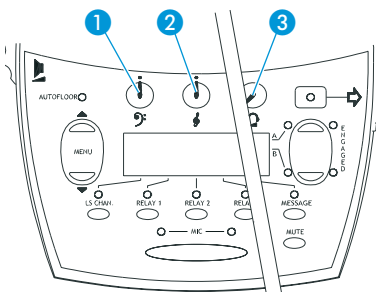

- ▶ Turn the control **3** to adjust the volume of the connected headphones.
- ▶ Turn the control **1** to adjust the middle response of the connected headphones.
- ▶ Turn the control **2** to adjust the treble response of the connected headphones.

Adjusting the volume of the interpreter consoles' built-in loudspeakers

To adjust the volume of the interpreter console's built-in loudspeaker, proceed as follows:

- ▶ Turn the control 22 to adjust the volume of the console's built-in loudspeaker.

Note!

The volume of the conference consoles' built-in loudspeakers can only be adjusted on the central unit!

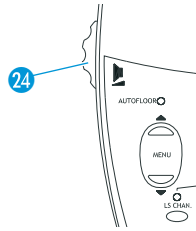

Configuring the B-channel of an interpreter console

If you interpret into a second language, but also if you interpret for other interpreters who take the relay (Auto-floor), configure the B channel of your console as follows:

- ▶ Press the "B-channel" key 8 and keep it pressed.
- ▶ While keeping the "B-channel" key pressed, press the "MENU ▲" or "MENU ▼" menu selection key 20 until the desired target language for the B-channel is shown on the display.

Note!

The A-channel of an interpreter console has to be configured via the central unit. The configuration of the A-channel cannot be changed on the console.

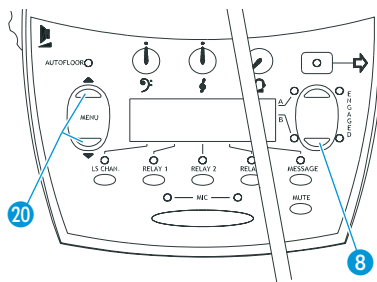

Setting the channel to be output via the interpreter console's built-in loudspeaker

To set the channel (e.g. the floor channel or an interpretation channel) to be output via the interpreter console's built-in loudspeaker:

- ▶ Press the LS CHAN. key 18 and keep it pressed.
- ▶ While keeping the LS CHAN key pressed, press the "MENU ▲" or "MENU ▼" menu selection key 20 until the desired channel is shown on the display.

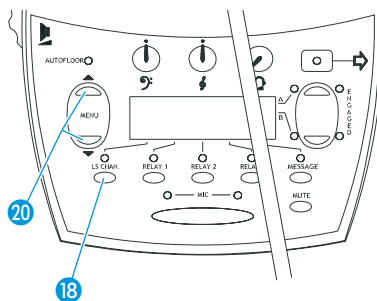

Selecting an interpretation channel

To select an interpretation channel to be output via your headphones:

- ▶ Press one of the keys RELAY 1, RELAY 2 or RELAY 3 17 and keep it pressed.
- ▶ While keeping one of the keys RELAY 1, RELAY 2 or RELAY 3 pressed, press the "MENU ▲" or "MENU ▼" menu selection key 20 until the desired language is shown on the display. The pressed key RELAY 1, RELAY 2 or RELAY 3 is assigned the interpretation channel with the selected language.
- ▶ To listen to the interpretation channel assigned to one of the keys RELAY 1, RELAY 2 or RELAY 3, press the corresponding key 17. The LED next to the key lights up. The selected interpretation channel is output via your headphones.

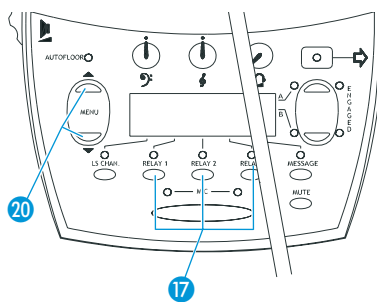

Using the interpreter console

As soon as your interpreter console is configured, you can use it as follows:

- ▶ Make sure that the correct channel for the target language is set (see “Switching between the A-channel and the B-channel” on page 39):
 - If you interpret into the main target language assigned to your booth, choose the A-channel.
 - If you interpret into a target language not assigned to your booth, choose the B-channel.
In this case, make sure that the B-channel is configured to the language into which you interpret (see “Configuring the B-channel of an interpreter console” on page 38)!
 - If you interpret a “rare” language into a language of which the other interpreters have a complete understanding and from which they then interpret into their respective languages (Auto-floor), also choose the B-channel.

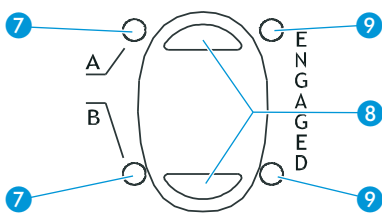

The green LEDs 7 indicate the selected channel (A or B).

- ▶ Make sure that the selected channel is not being used!
The red “ENGAGED” LED 9 of the selected channel must not light up!
- ▶ Press the MIC key 15 and start interpreting.
The red LED 9 of the selected channel lights up.
- ▶ Press the MIC key 15 once more to stop interpreting.
The red LED 9 of the selected channel goes off.

Switching between the A-channel and the B-channel

If you interpret into a second language, you have to switch from the A-channel to the B-channel.

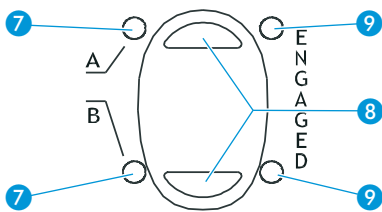

To switch to the B-channel:

- ▶ Press the “B-channel” key 8.
The green LED 7 next to the “B-channel” key lights up.

To switch to the A-channel:

- ▶ Press the “A-channel” key 8.
The green LED 7 next to the “A-channel” key lights up.

Muting the microphone of the interpreter console

To mute your microphone:

- ▶ Press the MUTE key 11 and keep it pressed.
Your microphone is muted.

To turn on your microphone again:

- ▶ Release the MUTE key 11.
Your microphone is turned on again.

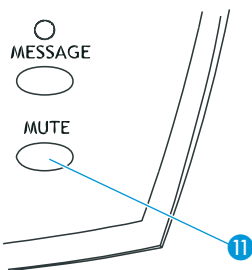

Displaying text messages on the interpreter console's display

If a PC with software control is connected to the central unit, you can receive text messages from the central unit.

If you have received a text message, the MESSAGE LED on your interpreter console lights up.

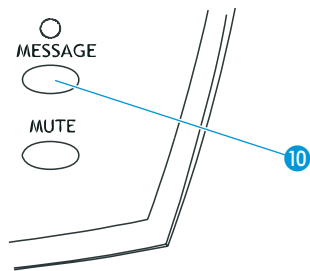

- ▶ Press the MESSAGE key **10**.
The text message is shown on the display.
- ▶ Press the MESSAGE key **10** again.
The display returns to the standard display.

Operating the central unit

Before a conference starts, you have to configure your entire conference and interpretation system via the central unit's operating menu (see "Configuring the SDC 8200 system" on page 61); it is, however, possible to make changes to individual settings during a conference.

Adjusting the volume of the consoles' built-in loudspeakers

Adjust the volume of the consoles' built-in loudspeakers so that all participants can clearly hear all audio information:

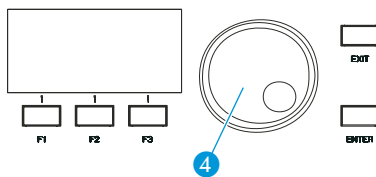

- ▶ Turn the jog wheel **4** on the central unit.
The volume of the consoles' built-in loudspeaker is increased or reduced. The bars on the start display indicate the set volume level.

Note!

The conference participants cannot adjust the volume of their consoles' built-in loudspeakers! However, each participant can individually adjust the headphone volume on his or her console. The interpreters can individually adjust both the volume of their consoles' built-in loudspeakers and the volume of the connected headphones.

Restarting the conference and interpretation system

The front panel of the central unit features a reset button which allows you to restart the central unit.

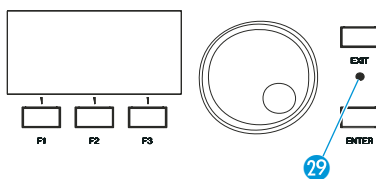

- ▶ Insert a pointed tool into the small hole **29** on the front panel of the central unit.
The central unit restarts with the last settings configured.

The F1, F2 and F3 function keys

The F1 and F3 function keys serve to lock the central unit.

To lock the central unit:

- ▶ Make sure that the start display appears as shown on the left. If the start display does not appear, press the EXIT key repeatedly until the start display appears.



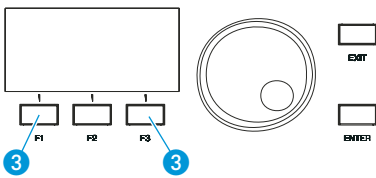

- ▶ Simultaneously press the F1 and F3 function keys 3 and keeps them pressed for three seconds.
If you release the two function keys after three seconds, the “key” symbol (⌘) appears in the lower right corner of the display. The operating menu of the central unit is locked and you cannot change the settings of your conference.

To unlock the central unit:



- ▶ Simultaneously press the F1 and F3 function keys 3 and keeps them pressed for three seconds.
If you release the two function keys after three seconds, the “key” symbol (⌘) disappears from the lower right corner of the display. The operating menu of the central unit can be accessed at any time by pressing the ENTER key (see “Working with the central unit’s operating menu” on page 41), and you can change all settings of your conference.

The menu operating controls

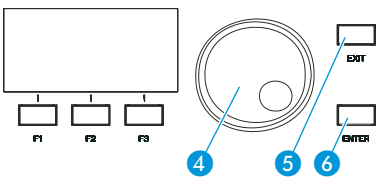

The jog wheel 4 and the ENTER 6 and EXIT 5 keys on the central unit allow you to navigate through the central unit’s operating menu, to choose settings and to enter and change values.

Operating control	Menu level	To
Jog wheel	main menu	choose a menu item
	submenu	choose a menu item or choose the desired setting
ENTER key	main menu and submenu	activate a selected menu item or save settings and return to the previous menu level
EXIT key	main menu and submenu	exit a menu item without saving the settings and return to the previous menu level

For a complete overview of all menus of the central unit, see “Introduction to the central unit’s operating menu” on page 61 to 85.

Working with the central unit’s operating menu

To choose a menu item from the central unit’s operating menu:

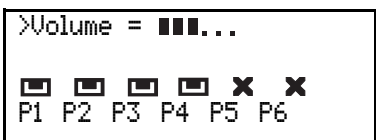

- ▶ Make sure that the central unit is turned on and that all conference/interpreter consoles are connected.
The start display appears, showing the current volume setting for the consoles’ built-in loudspeakers (see “Setting the volume of the consoles’ built-in loudspeakers” on page 86) and to which of the central unit’s ports P1 to P6 a cable string is connected (see “Making a system diagnosis” on page 112).

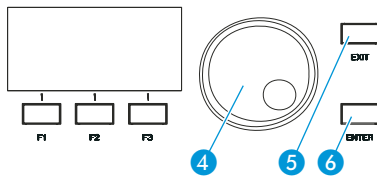

- ▶ Press the ENTER key 6.
You get to the first main menu "Conference".
- ▶ Turn the jog wheel 4 until the desired main menu is shown on the display and press the ENTER key 6.
You enter the desired main menu.
- ▶ Turn the jog wheel 4 until the desired submenu is shown on the display and press the ENTER key 6.
You enter the desired submenu where you can choose between additional submenu items by using the jog wheel 4 or choose a setting (in this case, the current value and the text "Press ENTER to Save" are shown on the display).
- ▶ To change the current value:
Turn the jog wheel 4 until the desired value is shown on the display and press the ENTER key 6.
The new value is saved and you return to the previous menu level.
- ▶ To keep the current value unchanged:
Press the EXIT key 5.
The current value remains unchanged and you return to the previous menu level.
- ▶ To exit the central unit's operating menu, press the EXIT key 5 repeatedly until the start display appears.

Via the central unit's operating menu, you can

- select one out of ten possible conference modes (see "Selecting a conference mode" on page 89)

Note!

The selection of some of the conference modes only makes sense if your conference and interpretation system is PC controlled

- adjust the volume, treble, middle and bass response of the consoles' built-in loudspeakers (see "Adjusting the audio settings for the consoles' built-in loudspeakers" on page 90)
- configure the options for the conference (see "Configuring the conference system" on page 86) and interpretation system (see "Configuring the interpretation system" on page 95)
- initialize the conference consoles (see "Automatically initializing all conference consoles" on page 86 or see "Manually initializing all conference consoles" on page 87) and the interpreter consoles (see "Half-automatically initializing all interpreter consoles on the central unit" on page 101 or see "Manually assigning an interpreter console an individual booth number" on page 102)
- specify the indication of the voting options on the displays
- choose the audio settings for the AUX inputs and outputs of the central unit
- reset the conference and interpretation system (Reset)
- configure the interpreter booths and the interpreter consoles
- save and load the interpreter configurations

Structuring the SDC 8200 system

This chapter provides information on how your system can be structured and which components are required for the different expansion stages.

Finally, this chapter also gives an overview of additional audio equipment that can be connected to the system.

Interconnecting the conference/interpreter consoles

Via the system cables, interconnect the consoles in cable strings.

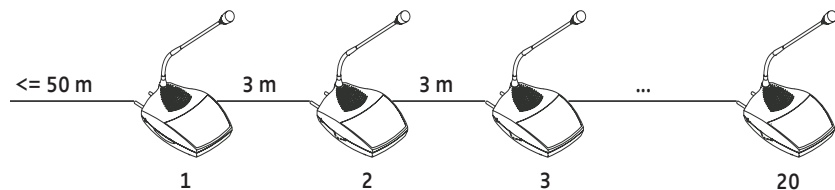

When interconnecting the consoles in strings, please observe the following:

- Conference and interpreter consoles can be interconnected in any desired order.
- A maximum of 20 consoles can be interconnected in one string.
- Calculate the maximum cable length and ensure that all consoles of a string are supplied with sufficient voltage (see “Determining maximum cable lengths” on page 46).

Connecting cable strings to a central unit

Via each of the six ports 16 of the central unit, you can connect a cable string.

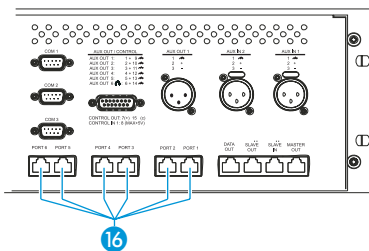

- Per SDC 8200 CU central unit, you can connect up to 120 (6 x 20) consoles.
 - Per SDC 8200 CU-M central unit, you can connect up to 50 (e.g. 5 x 10 or 3 x 15 + 1 x 5) consoles.
- ▶ Calculate the maximum cable length using the “Powercalc.exe” software (see “Determining maximum cable lengths” on page 46) in order to ensure that all consoles are supplied with sufficient voltage.

Interconnecting up to twelve SDC 8200 CU central units

For conference and interpretation systems with up to 1024 consoles, you can interconnect a total of twelve SDC 8200 CU central units (see “Interconnecting several central units (SDC 8200 CU central unit only)” on page 54).

You **cannot** interconnect SDC 8200 CU-M central units.

The three expansion stages

Depending on the number of conference participants, three different expansion stages are distinguished:

- Expansion stage (1) comprising one central unit with up to 20 consoles
- Expansion stage (2) comprising one SDC 8200 CU central unit with up to 120 consoles or one SDC 8200 CU-M central unit with up to 50 consoles
- Expansion stage (3) comprising several SDC 8200 CU central units with up to 1024 consoles

Note!

In the following examples, the standard length of “3 m” is always given for the system cables between the conference consoles. However, it is no problem to use other cable lengths or cables of differing lengths within the same string.

To make sure that all consoles are supplied with a voltage of at least 30 V, please refer to the chapter “Determining maximum cable lengths” on page 46.

Expansion stage (1): one central unit with up to 20 consoles

In small conference systems (expansion stage 1), up to 20 conference and interpretation consoles can be interconnected in one string.

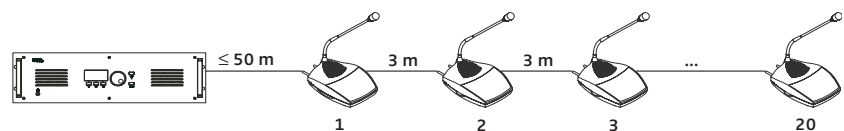

- ▶ Calculate the maximum cable length using the “Powercalc.exe” software (see “Determining maximum cable lengths” on page 46) in order to ensure that all consoles are supplied with sufficient voltage.

Expansion stage (2): one central unit with up to 120 or 50 consoles

In conference systems of expansion stage (2), up to six cable strings with up to 20 consoles each ($6 \times 20 = 120$) can be connected to a single SDC 8200 CU central unit. This is the maximum number of consoles that can be connected to a single central unit.

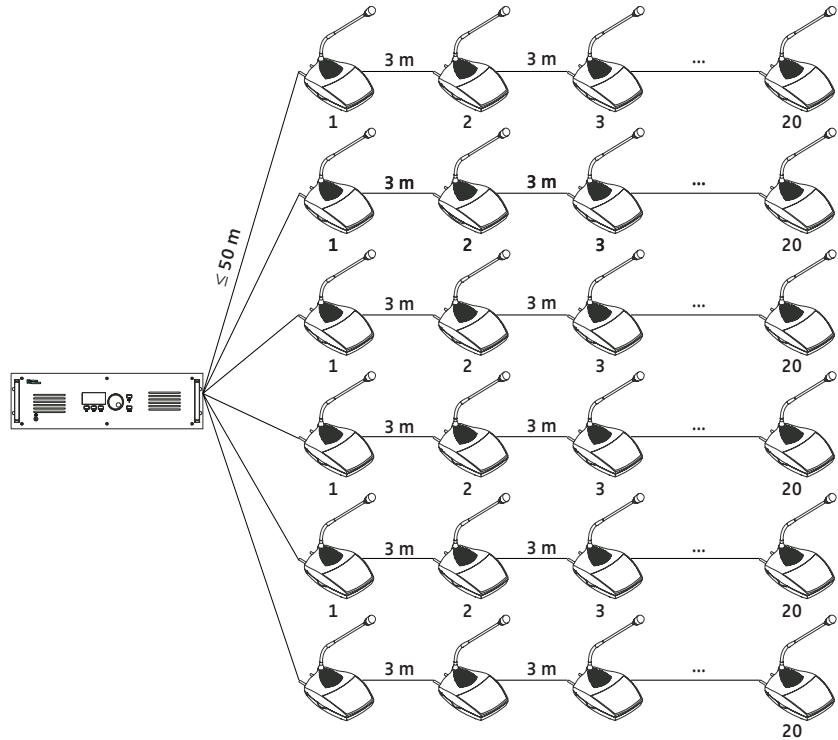

- ▶ Calculate the maximum cable length using the "Powercalc.exe" software (see "Determining maximum cable lengths" on page 46) in order to ensure that all consoles are supplied with sufficient voltage.

Expansion stage (3): several interconnected SDC 8200 CU central units with up to 1024 consoles

For larger conference and interpretation systems with up to 1024 consoles, you can interconnect a total of 12 central units. The additional central units are connected as “slaves” to the central unit configured as “master”. If the conference and interpretation system is to be PC controlled, the PC must be connected to the “master” central unit.

To set up a conference system with several central units, you first have to interconnect the consoles in cable strings and then connect the cable strings to the central units. Finally, you interconnect the central units (see “Interconnecting several central units (SDC 8200 CU central unit only)” on page 54).

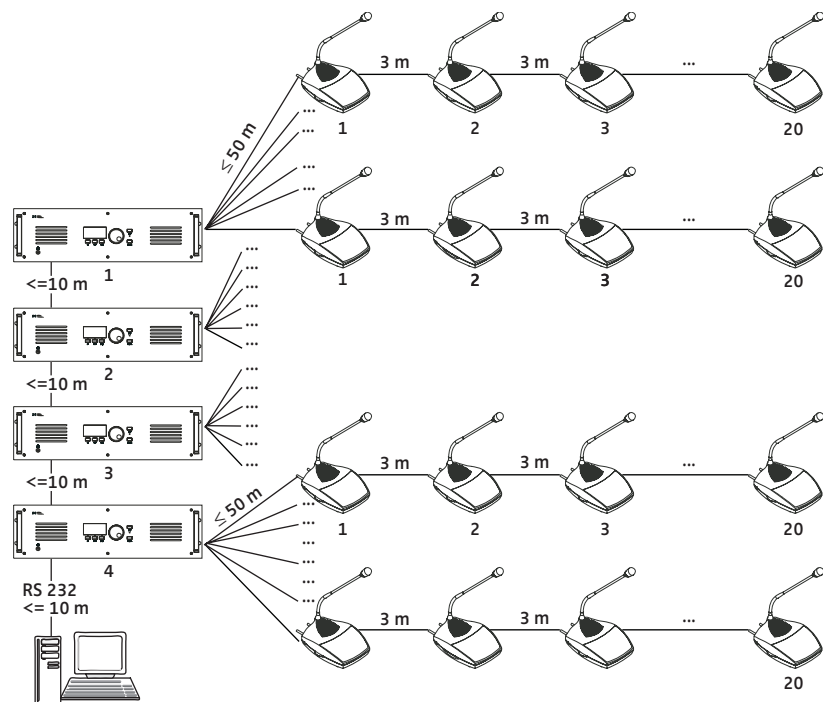

- ▶ Calculate the maximum cable length using the “Powercalc.exe” software (see “Determining maximum cable lengths” on page 46) in order to ensure that all consoles are supplied with sufficient voltage.

The maximum length of the system cables used for interconnecting the central units must not exceed 10 m.

Determining maximum cable lengths

In the preceding examples, the standard length of “3 m” is always given for the system cables between the conference consoles. However, it is no problem to use other cable lengths or cables of differing lengths within the same string.

However, if you wish to use longer cables, make sure that all consoles – including the last one in a string – are supplied with a voltage of at least 30 V!

Calculating the voltage drop on the system cables

Every meter of system cable and every console in a string causes a voltage drop. Thus, the further back a console is located in a string, the less voltage it receives.

Delivery includes a the calculating program "Powercalc.exe" with which you can easily calculate the voltage drops on the individual sections of a string. In this way, you know even before setting up the conference system whether it will work or not.

This program can also be downloaded from www.sennheiser.com.

Structuring an interpretation system

If your SDC 8200 system comprises interpreter consoles, these are usually installed in acoustically isolated interpreter booths so that the interpreters cannot disturb each other or the audience.

One booth with a team of interpreters is normally required per target language. Within one language team, interpreters will take turns every twenty minutes or so, in order to give each other an adequate break and maintain a high level of quality.

Your SDC 8200 interpretation system can comprise

- a maximum of 224 interpreter consoles,
- a maximum fo 28 intepreter booths,
- a maximum of eight interpreter consoles per booth.

Within a booth, each interpreter console has to be assigned a number, with the numbering starting always from 1.

The interpreter consoles can be connected anywhere in the cable strings.

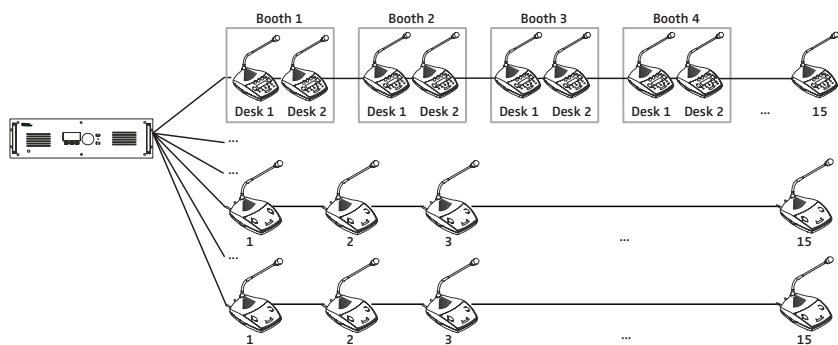

Selectable modes between or within interpreter booths

With the SDC 8200 system, you can choose between three “modes between booths” and two “modes in booth”.

Via the “modes between booths”, you fix the responsibilities of interpreters who are seated in different booths but interpret into the same target language (one on the A-channel and another on the B-channel).

Via the “modes in booths”, you fix the responsibilities of interpreters who are seated in the same booth and interpret into the same target language.

Mode between booths: “Mixed”

Interpreters who are seated in different booths but interpret into the same target language can activate their interpreter consoles any time by pressing the MIC key 15 – even simultaneously.

When two interpreters simultaneously interpret into the same target language, the red signal light ring 12 and the “Microphone active” LED 14 on their consoles light up.

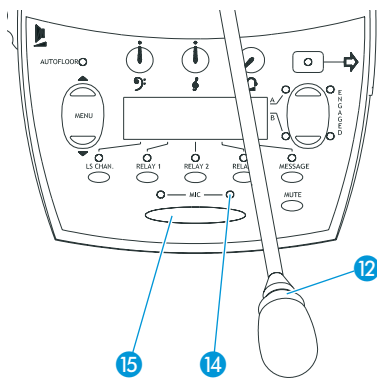

Mode between booths: “Override”

Interpreters who are seated in different booths but interpret into the same target language can activate their interpreter consoles any time by pressing the MIC key 15 – however, activating an interpreter console will automatically turn off the currently active interpreter console.

In “Override” mode, an interpreter console that was just turned off can only be turned on again if the interpreter console by which it was turned off is deactivated.

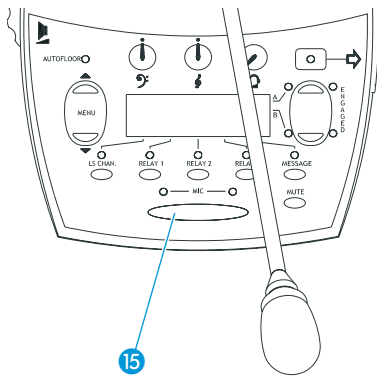

Mode between booths: “Toggle Override”

Interpreters who are seated in different booths but interpret into the same target language can activate their interpreter consoles any time by pressing the MIC key 15 – however, activating an interpreter console will automatically turn off the currently active interpreter console.

In “Toggle Override” mode, an interpreter console that was just turned off can be turned on again any time by pressing the MIC key 15.

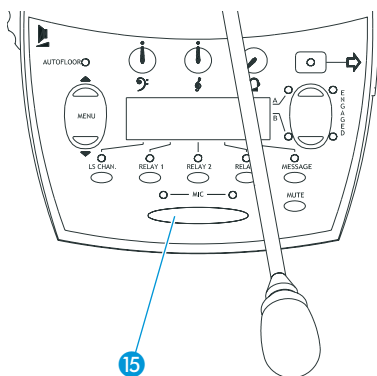

Mode in booths: "Mixed"

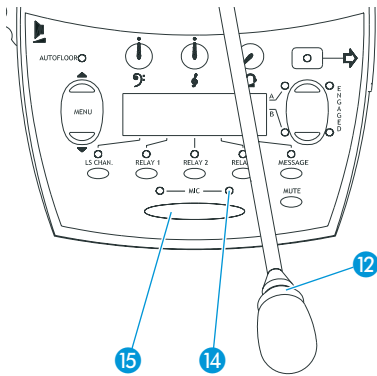

Interpreters who are seated in the same booth and interpret into the same target language can activate their interpreter consoles any time by pressing the MIC key 15 – even simultaneously.

When two interpreters simultaneously interpret into the same target language, the red signal light ring 12 and the "Microphone active" LED 14 on their consoles light up".

Mode in booths: "Toggle Override"

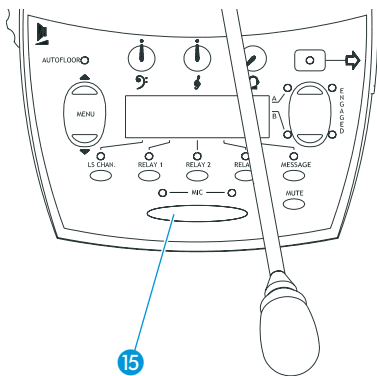

Interpreters who are seated in the same booth and interpret into the same target language can activate their interpreter consoles any time by pressing the MIC key 15 – however, activating an interpreter console will automatically turn off the currently active interpreter console.

In "Toggle Override" mode, an interpreter console that was just turned off can be turned on again any time by pressing the MIC key 15.

The "auto-floor" function

If the original floor language is **not** a language of which all interpreters have a complete understanding and from which they work, you can enable the auto-relay interpretation function (auto-floor): The original floor language is interpreted into a language understood by all interpreters. This interpretation is automatically "relayed" to the floor channel of all other interpreters and serves as the basis from which they interpret into their respective target languages.

Example:

The active languages at a conference are English, German and French (active languages are the languages into which interpretation is provided).

However, some of the delegates speak Russian, a language of which only one interpreter has a complete understanding. This interpreter interprets the contributions of the Russian delegates into English, which the other interpreters then interpret into their respective target languages. The English interpretation is also fed to the English interpretation channel.

The below illustration shows the relay interpretation process (auto-floor).

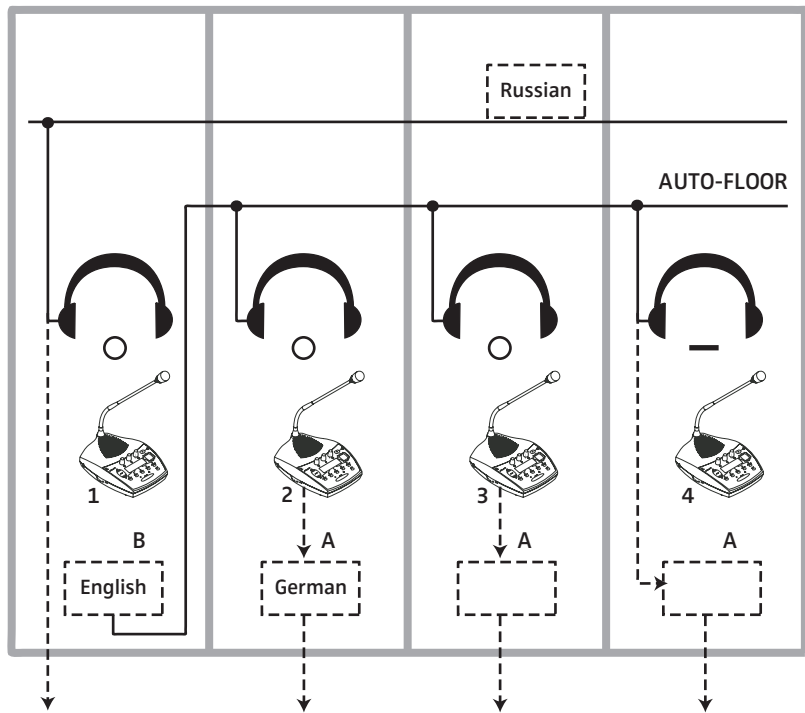

If the original floor language is a language of which all interpreters have a complete understanding and from which they work, you **do not** have to enable this function. In this case, all interpreters interpret the original floor language into their respective target languages. These interpretations are fed to the corresponding interpretation channels.

The below illustration shows the normal interpretation process where the original floor language is directly interpreted into the target languages.

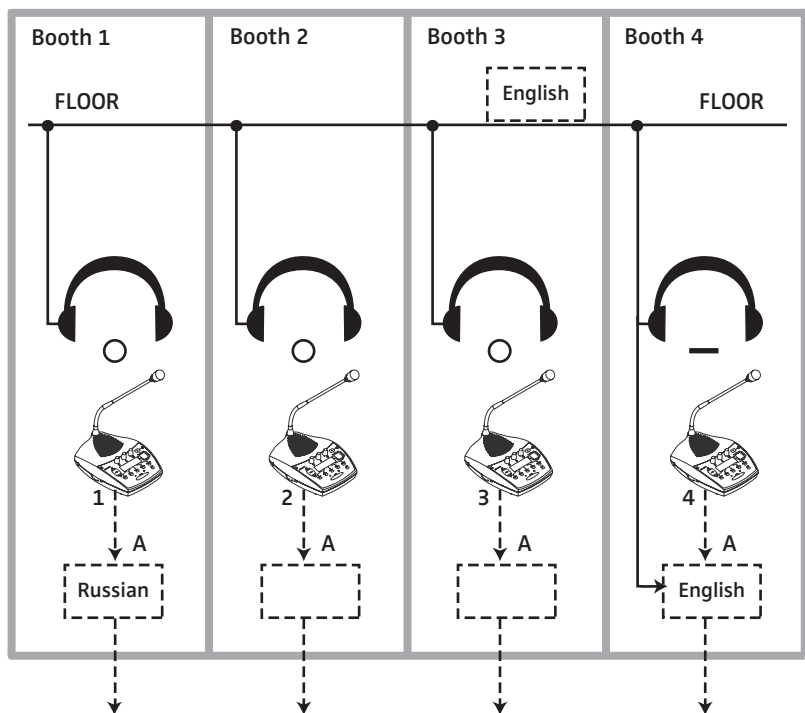

Using external equipment

External audio signals can be fed to the conference and interpretation system and channels (floor channel and interpretation channels) can be output. You can, for example,

- connect a wireless microphone, enabling a speaker to move around freely and to speak from anywhere in the room,
- feed external audio signals (e.g. the soundtrack of a video, music, announcements from a tape, etc.) into the system,
- connect a PA system,
- connect an infrared language distribution system,
- directly transmit channels to broadcasting and TV stations,
- and record individual channels for documentation or archiving purposes.

Note!

Please note that a total of two audio sources can be connected to the central unit and that a total of four channels plus the floor channel can be output. If you wish to output more channels, you require the optional SDC 8200 AO analog output unit.

Connecting external audio sources

Via the two XLR-3F sockets (AUX IN 1 **8** and AUX IN 2 **9**) of the central unit, external audio sources which output a balanced mono signal can be connected to the conference system.

External audio sources are, for example:

- wired microphones
- wireless microphones
- the audio output of a video recorder
- a CD player

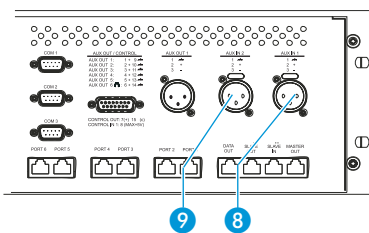

The signals available at the audio inputs AUX IN 1 and AUX IN 2 are fed to the floor channel which is output via the consoles' built-in loudspeakers. For information on how to turn on the audio inputs and how to adjust the volume and the input sensitivity, see:

- "Turning on/off the audio inputs or outputs" on page 108,
- "Adjusting the input level of an audio input" on page 110 and
- "Adjusting the input sensitivity of an audio input" on page 110.

Transmitting the floor channel and the interpretation channels to broadcasting and TV stations

Important conferences and specialist congresses are of great interest to the public. The SDC 8200 conference and interpretation system, therefore, allows you to transmit the floor channel and the interpretation channels e.g. to broadcasting and TV stations.

The floor channel is available at the XLR-3M audio output (AUX OUT 1) and the 15-pole sub-D socket (AUX OUT 2).

The signals of up to four interpretation channels are available at the outputs AUX OUT 2-3-4-5-6 of the 15-pole sub-D socket.

Additional interpretation channels can be output via the XLR-3M audio outputs of an SDC 8200 AO analog output unit connected to the central unit.

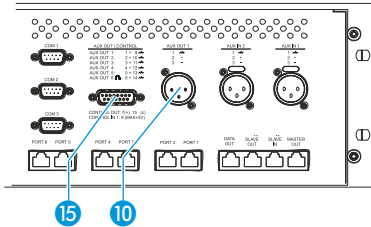

Transmitting the floor channel or an interpretation channel via a PA system

Via the central unit's XLR-3M audio output or via an audio output of the SDC 8200 AO analog output unit, you can connect a PA system via which the floor channel or an interpretation channel can be transmitted to e.g. the foyer or another room.

For information on how to select the channel to be output via an audio output, see "Assigning a channel to an audio output" on page 107.

Transmitting the floor channel and the interpretation channels via an infrared transmission link

You can connect the control of an infrared transmitter to the central unit, allowing guests or participants who don't have their own conference console to follow the conference via infrared headphones. These guests or participants can choose between the floor channel and the interpretation channels.

Setting up the SDC 8200 system

This chapter provides information on how to set up and operate the SDC 8200 conference and interpretation system.

Preparing the SDC 8200 system components for set up

Conference and interpreter consoles

After unpacking the consoles, you simply have to connect them to the central unit and initialize them.

Central unit

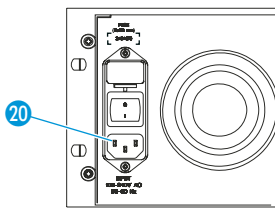

- ▶ Connect the mains cable to socket 20.
- ▶ Connect the mains cable to the mains (100 – 240 V, 50 – 60 Hz).

Rack-mounting several SDC 8200 CU central units

For larger conference and interpretation systems with several SDC 8200 CU central units, we recommend mounting the central units into a rack.

- ▶ Mount the central unit into a 19" rack and fix it to the rack by means of four screws.

Caution!

Some furniture surfaces have been treated with varnish, polish or synthetics which might cause stains when they come into contact with other synthetics. Despite a thorough testing of the synthetics used by us, we cannot rule out the possibility of staining.

Interconnecting the SDC 8200 system components

Depending on the expansion stage of your system, you have to:

- interconnect the consoles (all expansion stages),
- interconnect the central units (expansion stage 3),
- connect a PC to the "master" central unit if the system is to be PC controlled.

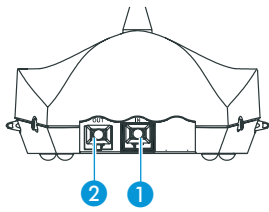

Interconnecting the consoles

To interconnect the consoles via the system cables:

- ▶ Connect the black RJ 45 plug of the system cable to the OUT socket 2 of the console.
- ▶ Connect the grey RJ 45 plug of the system cable to the IN socket 1 of the console.

Note!

You can interconnect up to 20 consoles in one cable string.

Connecting a cable string to the central unit

After having interconnected the consoles, connect the cable strings to the central unit. You can connect up to six cable strings to a single central unit. To connect a cable string to the central unit:

- ▶ Connect the black RJ 45 plug of the system cable to one of the RJ 45 sockets labelled PORT 1 to PORT 6 16 of the central unit.
- ▶ Connect the grey RJ 45 plug of the system cable to the IN socket 1 of the first console of a cable string.
- ▶ Initialize the consoles as described in the section "Turning on the central unit for the first time" on page 86.

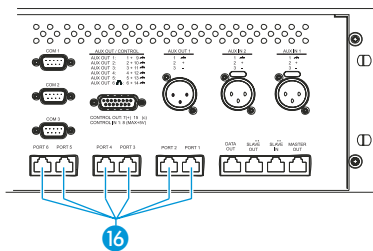

Interconnecting several central units (SDC 8200 CU central unit only)

You can only interconnect SDC 8200 CU central units. The length of the system cables between the SDC 8200 CU central units must not exceed 10 m. If you wish to interconnect several SDC 8200 CU central units, we recommend mounting the central units into a rack.

To interconnect several SDC 8200 CU central units:

- ▶ At the first central unit, connect the black RJ 45 plug of the system cable to the MASTER OUT socket 11. If the SLAVE IN socket 12 of a central unit is not connected, this central unit automatically becomes the "master".
- ▶ Connect the grey RJ 45 plug of the system cable connected to the "master" to the SLAVE IN socket 12 of the second central unit. If the SLAVE IN socket 12 of a central unit is connected, this central unit automatically becomes a "slave".
- ▶ To connect additional "slaves", connect the SLAVE OUT 13 socket of the first "slave" to the SLAVE IN 12 socket of the following "slave", and so on.

Note!

The entire conference and interpretation system is configured, managed and controlled exclusively via the "master" central unit. All operating controls on the "slaves" are locked, except for the F2 key. This is indicated by a "key" symbol (⌘) in the lower right corner of the display.

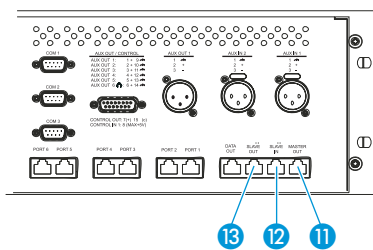

Turning the interconnected SDC 8200 CU central units on and off

When turning on a conference and interpretation system with several central units, it is important that the central units are turned on in the correct order.

- ▶ First turn on the "master" central unit.
- ▶ Then turn on the "slave" central units in the order in which they are connected to the "master".

To turn a central unit on:

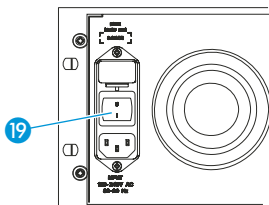

- ▶ Set the POWER switch 19 to position "I".
The consoles which are powered via this central unit are ready for operation as soon as they are initialized.
The start display is shown on the LC display of this central unit.

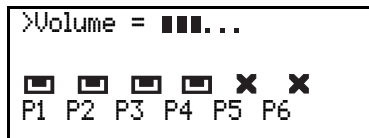

To turn a central unit off:

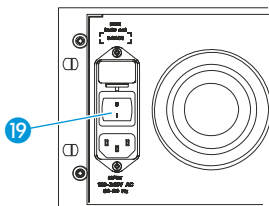

- ▶ Set the POWER switch 19 to position "0".
The display goes off. All consoles which were powered via this central unit are also turned off.

Note!

It is, however, possible to simultaneously turn on interconnected central units via a switchable multiple socket.

Exiting the "slave" mode of a central unit

If several SDC 8200 CU central units are interconnected, the operating controls of all "slave" central units are locked, except for the F2 function key. With the F2 function key, you can unlock the operating controls of a "slave", which then automatically becomes a "master". This allows you to e.g. configure the AUX outputs or to divide a large conference and interpretation system up into several smaller systems.

To unlock the operating controls of a "slave" central unit:

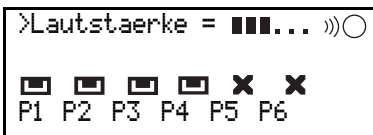

- ▶ Press the F2 function key 3 and keep it pressed for three seconds.
The operating controls are unlocked. The "master" icon))○ appears in the upper right corner of the display.

Note!

Please note that the new "master" central unit is no longer connected to the conference system.

To reintegrate the "slave" central unit into the conference system and to lock the operating controls:

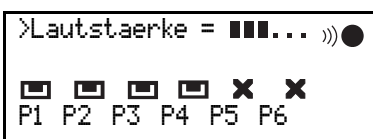

- ▶ Press the F2 function key 3 and keep it pressed for three seconds.
The operating controls are locked. The "slave" icon))● appears in the upper right corner of the display.

Connecting additional equipment

Via the two **audio inputs** AUX IN 1 and AUX IN 2 of the central unit, you can connect microphones with suitable preamplifiers or you can feed audio signals from additional audio equipment to the conference system.

The external audio signals are fed to the floor channel which is output via the consoles' built-in loudspeakers.

The output signal of the floor channel is available at the **audio output** AUX OUT 1. Via the five audio outputs AUX OUT 2 to AUX OUT 6, you can output any desired channel (floor channel or interpretation channels).

Via the audio outputs, you can:

- connect a PA system via which the floor channel or an interpretation channel can be transmitted to e.g. the foyer or another room,
- transmit the audio signal of the floor channel or an interpretation channel as "original soundtrack" to a broadcasting station,
- connect an infrared language distribution system to the central unit, allowing guests or participants who don't have their own conference console to follow the conference via infrared headphones. With the SDC 8200 CU central unit, guests or participants can choose between the floor channel and up to 28 interpretation channels. With the SDC 8200 CU-M central unit, guests or participants can choose between the floor channel and up to four interpretation channels.

Optionally, you can connect an SDC 8200 AO analog output unit to the central unit. The analog output unit features nine XLR-3M audio outputs via which you can output the floor channel and up to eight additional interpretation channels and to which you can connect external equipment such as a recording unit, etc.

Connecting external audio sources

You can connect external audio sources such as wired microphones, wireless microphone systems, the audio output of a video recorder, a CD player, etc. to the central unit. The audio sources to be connected must deliver a balanced mono signal at the XLR-3F sockets.

The external audio signals are fed to the floor channel which is output via the consoles' built-in loudspeakers.

To connect an audio source:

- ▶ Use an audio cable with XLR-3 connectors to connect the audio source to one of the XLR-3F sockets (AUX IN 1 **8** or AUX IN 2 **9**) of the central unit.
- ▶ If necessary, adapt the input sensitivity and the volume of the audio input via the central unit's operating menu (see "Adjusting the input sensitivity of an audio input" on page 110 and "Adjusting the input level of an audio input" on page 110).

You can turn the audio inputs on and off via the central unit's operating menu (see "Turning on/off the audio inputs or outputs" on page 108).

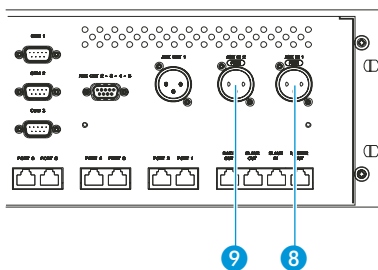

Setting up remote conferences

Instead of connecting an external audio source to the audio input of your conference system, you can connect the audio output of a conference system installed in a separate room to carry out a remote conference. The participants of both conferences can then participate in a common conference.

To connect two conference systems installed in separate rooms, you require two XLR cables with two XLR-3 connectors respectively:

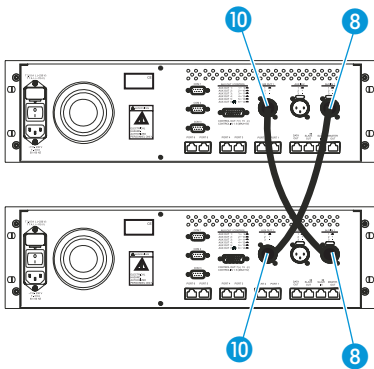

- ▶ Connect the audio input AUX IN 1 **8** of the first central unit to the audio output AUX OUT 1 **10** of the second central unit.
- ▶ Connect the audio input AUX IN 1 **8** of the second central unit to the audio output AUX OUT 1 **10** of the first central unit.
- ▶ From the central unit's operating menu, choose "Dist. Conf. = ON" to prevent echo (see "Configuring the audio outputs for remote conferencing" on page 109).

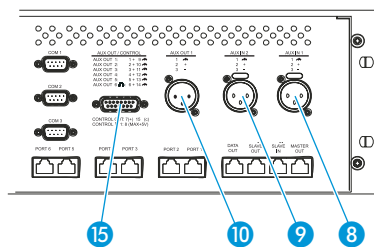

Connecting PA systems, recording units, etc.

Via the audio outputs you can connect e.g. a PA system, a recording unit, etc.

Connect the desired unit as follows:

- ▶ The signals of the floor channel are available at the XLR-3M audio output AUX OUT 1 **10** and the 15-pole sub-D socket AUX OUT 2 **15**.
- ▶ The signals of up to four interpretation channels are available at the outputs AUX OUT 2-3-4-5-6 **15** of the 15-pole sub-D socket.
- ▶ If an SDC 8200 AO analog output unit is connected to the DATA OUT socket **14** of the SDC 8200 CU central unit, additional channels can be output via the analog output unit's XLR-3M audio outputs.

Pin assignment of the 15-pole sub-D socket (AUX OUT 2-3-4-5-6)

When connecting external equipment to the 15-pole sub-D socket (AUX OUT 2-3-4-5-6 **15**), please observe the following pin assignment:

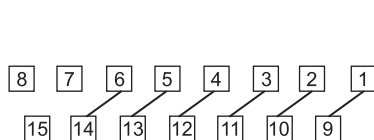

PIN	SIGNAL
1+9	Aux Out 1
2+10	Aux Out 2
3+11	Aux Out 3
4+12	Aux Out 4
5+13	Aux Out 5
6+14	Aux Out 6
7	not assigned
8	not assigned
15	not assigned

The audio signal of the floor channel is always available at the two outputs AUX OUT 1 (XLR-3M audio output) and AUX OUT 2 (pin 2 and 10 of the 15-pole sub-D socket). This assignment cannot be changed!

The channel assignment for the four other audio outputs can be changed as described in the section “Assigning a channel to an audio output” on page 107. You can assign these outputs any interpretation channel or the floor channel.

Note!

The audio signal of the channel assigned to the output AUX OUT 6 (pin 6 and 14 of the 15-pole sub-D socket) is also available at the headphone output of the central unit!

Connecting an SDC 8200 AO analog output unit to the SDC 8200 CU central unit

You can output additional interpretation channels via the SDC 8200 AO analog output unit’s transformer balanced XLR-3M audio outputs or via the unbalanced phono sockets next to the XLR-3 outputs.

To connect an analog output unit to the SDC 8200 CU central unit:

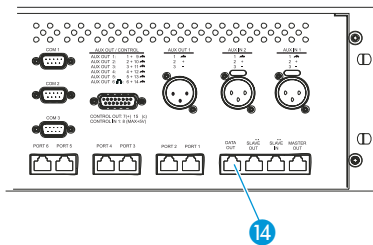

- ▶ Connect the black RJ 45 plug of the system cable to the DATA OUT socket 14 of the central unit.
- ▶ Connect the grey RJ 45 plug of the system cable to the DIGITAL BUS IN socket of the analog output unit.

Connecting several SDC 8200 AO analog output units to the SDC 8200 CU central unit

To connect several SDC 8200 AO analog output units to the SDC 8200 CU central unit:

- ▶ Connect the DIGITAL BUS OUT socket of the first SDC 8200 AO to the DIGITAL BUS IN socket of the second SDC 8200 AO, and so on.

Note!

You can connect up to four SDC 8200 AO analog output units to the SDC 8200 CU central unit.

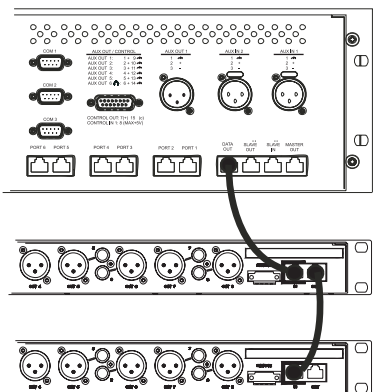

Connecting external equipment to the SDC 8200 AO's phoenix connector

The SDC 8200 AO is fitted with a voltage-free contact (phoenix connector) which turns external equipment (e.g. a recording unit) on and off. When a console is active, the contact is closed and when no console is active, the contact is open.

The phoenix connector is numbered from left to right as shown in the illustration on the left.

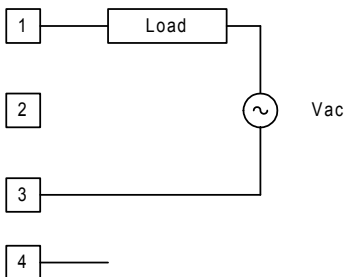
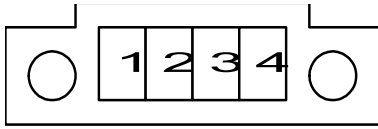

If you switch AC loads such as e.g. an electronic relay, the contacts 1 and 3 will be opened or short-circuited. Therefore, make sure that the following limitations are not exceeded!

- Maximum load current (continuous) = 1 A
- Maximum load voltage = 60 V
- On-resistance = 0.5 Ω

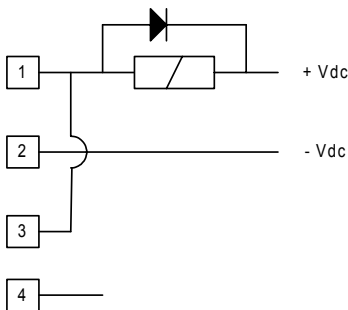

If you connect DC sources such as e.g. a relay coil, make sure that the following limitations are not exceeded!

- Maximum load current (alternating) = 1.8 A
- Maximum load voltage = 60 V
- On-resistance = 0.15 Ω

Connecting a PC to the central unit

If your system comprises interpreter consoles, you require a PC with two serial interfaces:

- The conference management software accesses the conference configuration via the central unit's COM 3 interface ②.
- The interpreter management software accesses the interpreter configuration via the central unit's COM 1 interface ①.

To connect a PC to the central unit:

- ▶ Connect one serial interface of the PC to the COM 3 interface ② of the central unit.
- ▶ Connect the other serial interface of the PC to the COM 1 interface ① of the central unit.

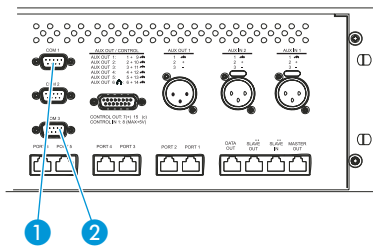

Note!

If you are using more than one central unit, the PC has to be connected to the "master" central unit.

For connecting a PC to the central unit, you require the cables shown below:

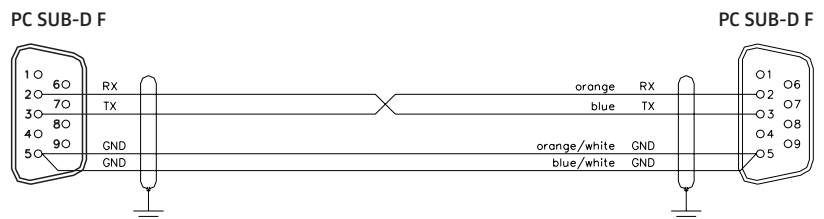
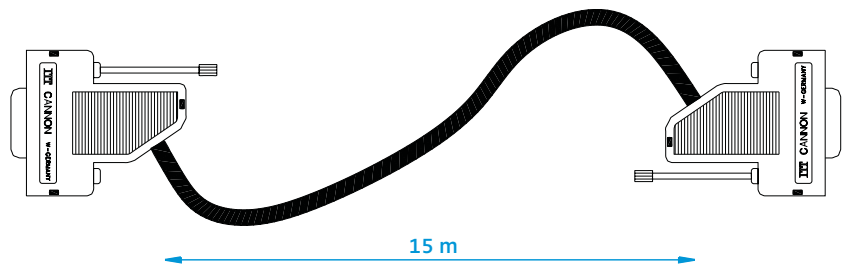

- Pin 1: Not connected
- Pin 2: RX Receive
- Pin 3: TX Transmit
- Pin 4: Not connected
- Pin 5: GND
- Pin 6: Not connected
- Pin 7: Not connected
- Pin 8: Not connected
- Pin 9: Not connected

- Pin 1: Not connected
- Pin 2: RX Receive
- Pin 3: TX Transmit
- Pin 4: Not connected
- Pin 5: GND
- Pin 6: Not connected
- Pin 7: Not connected
- Pin 8: Not connected
- Pin 9: Not connected

Configuring the SDC 8200 system

After having connected all system components, you have to configure your conference and interpretation system via the central unit's operating menu.

Introduction to the central unit's operating menu

Via the central unit's operating menu, the SDC 8200 conference and interpretation system can be configured for any room, any number of participants and any conference use.

Note!

General information on how to use the central unit's operating menu is given in the section "Working with the central unit's operating menu" on page 41.

The start display

After turning on the central unit, the start display appears, showing:

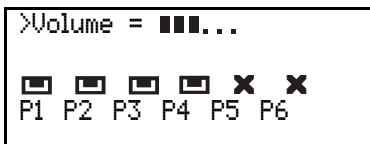

- the current volume setting for the consoles' built-in loudspeakers
- to which of the ports „P1“ to „P6“ of the central unit a cable string with consoles is connected

█: means: A cable string is connected to this port.

✘: means: No cable string is connected to this port (see section "Making a system diagnosis" on page 112).

To get from the start display into the central unit's operating menu:

- ▶ Press the ENTER key.
 - The "Conference" main menu appears on the display.

The six main menus

The central unit's operating menu consists of six main menus:

- Via the "Conference" menu, you can configure the conference system and the conference consoles.
- Via the "Interpretation" menu, you can configure the interpretation system and the interpreter consoles.
- Via the "Aux-In/Out" menu, you can choose the audio settings for the AUX inputs and outputs.
- Via the "System" menu, you can make a system diagnosis as well as activate and configure optional components for monitoring and controlling the system.
- Via the "* Language" menu, you can choose the language of the operating menu.
- Via the "License" menu, you can display the serial number of the central unit, display the current license code and enter a new license code.

The following overview shows how to navigate through the main menus.

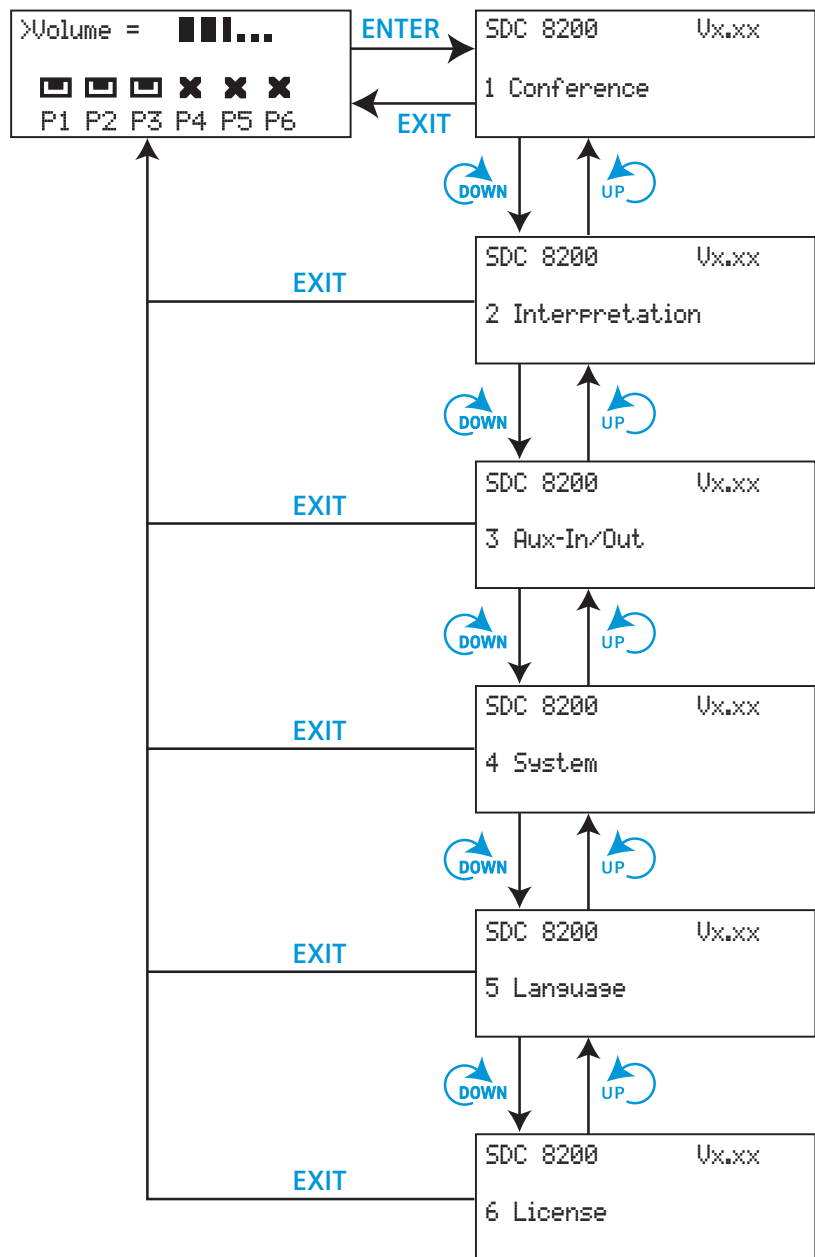

An overview of the settings that can be adjusted in the main and submenus is given on the following pages.

The submenus of the "Conference" menu (part 1 of 7)

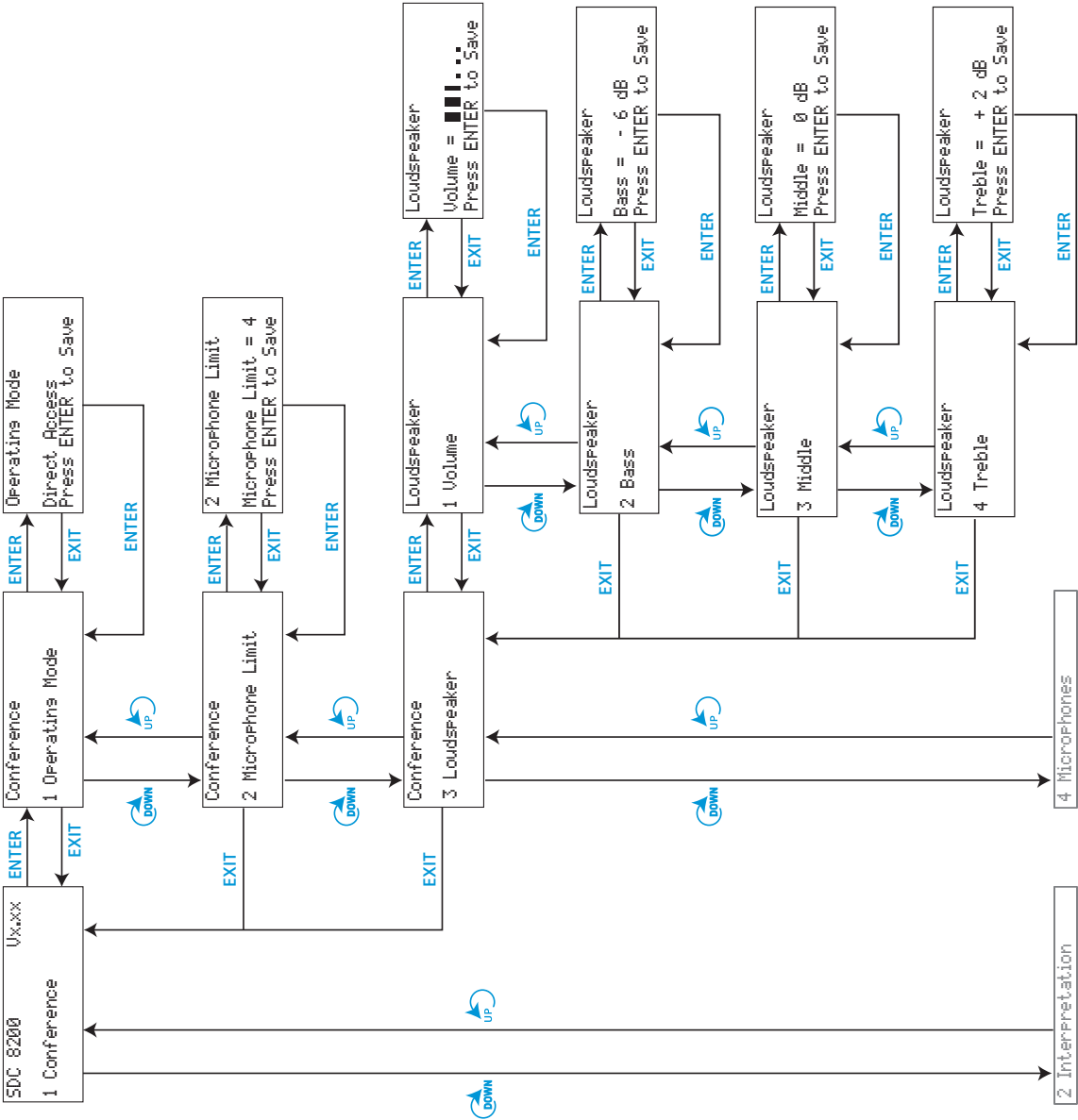

The submenus of the "Conference" menu (part 2 of 7)

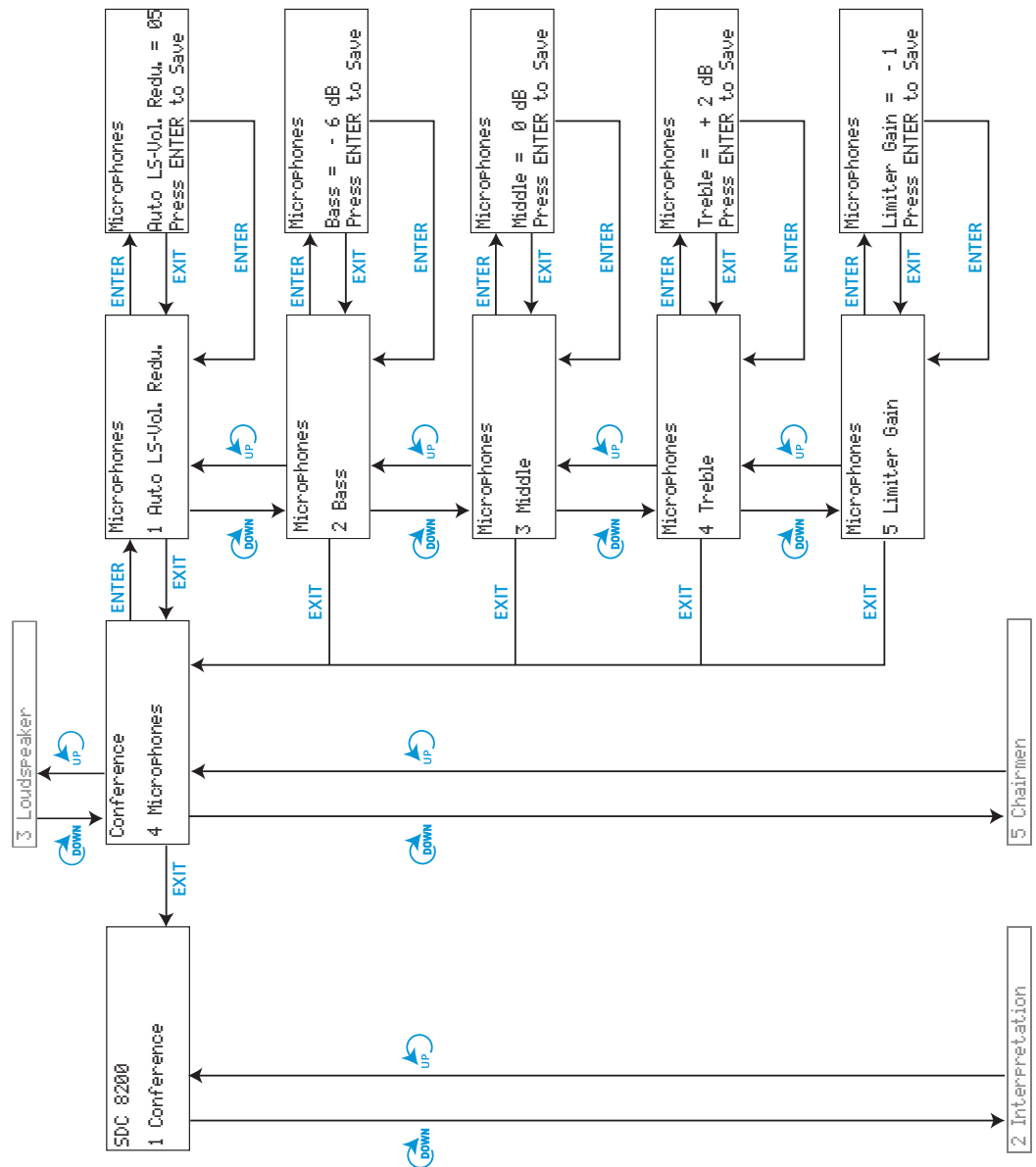

The submenus of the "Conference" menu (part 4 of 7)

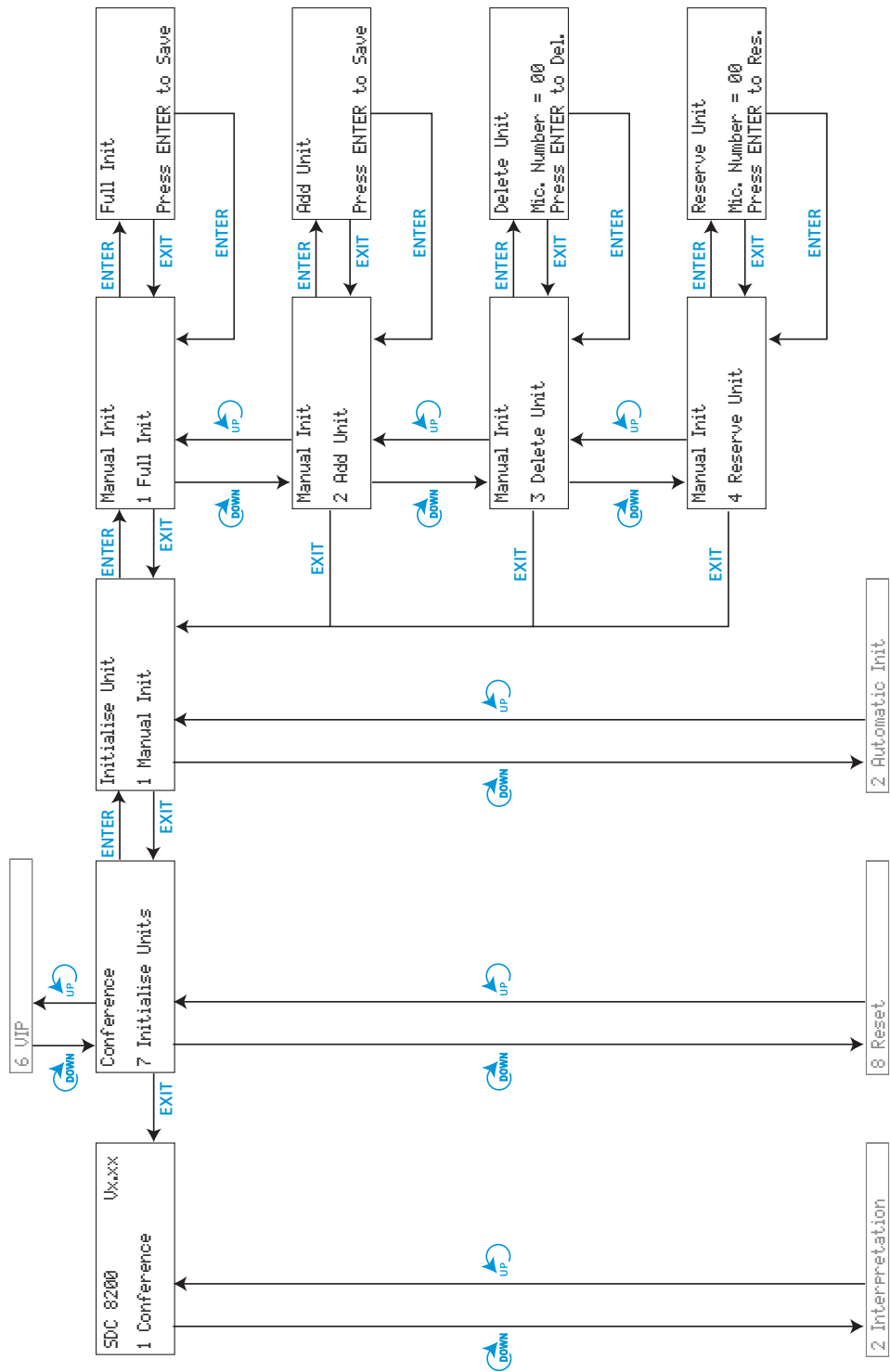

The submenus of the "Conference" menu (part 5 of 7)

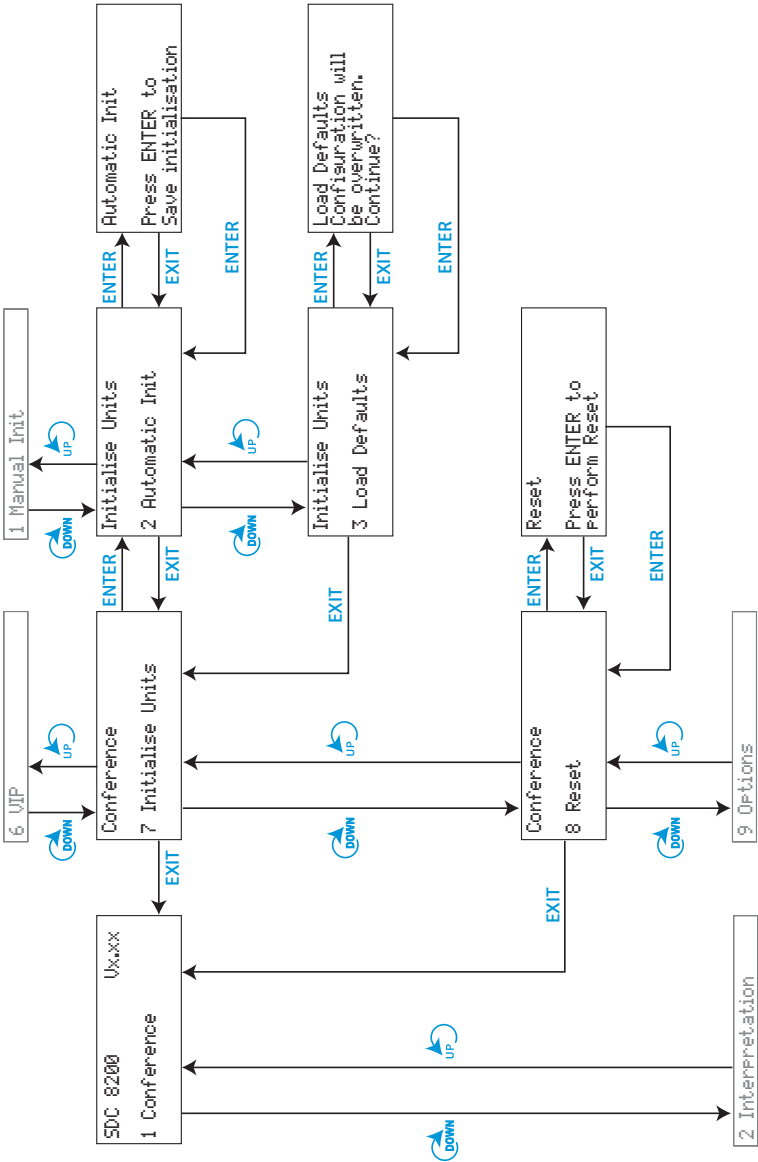

The submenus of the "Conference" menu (part 6 of 7)

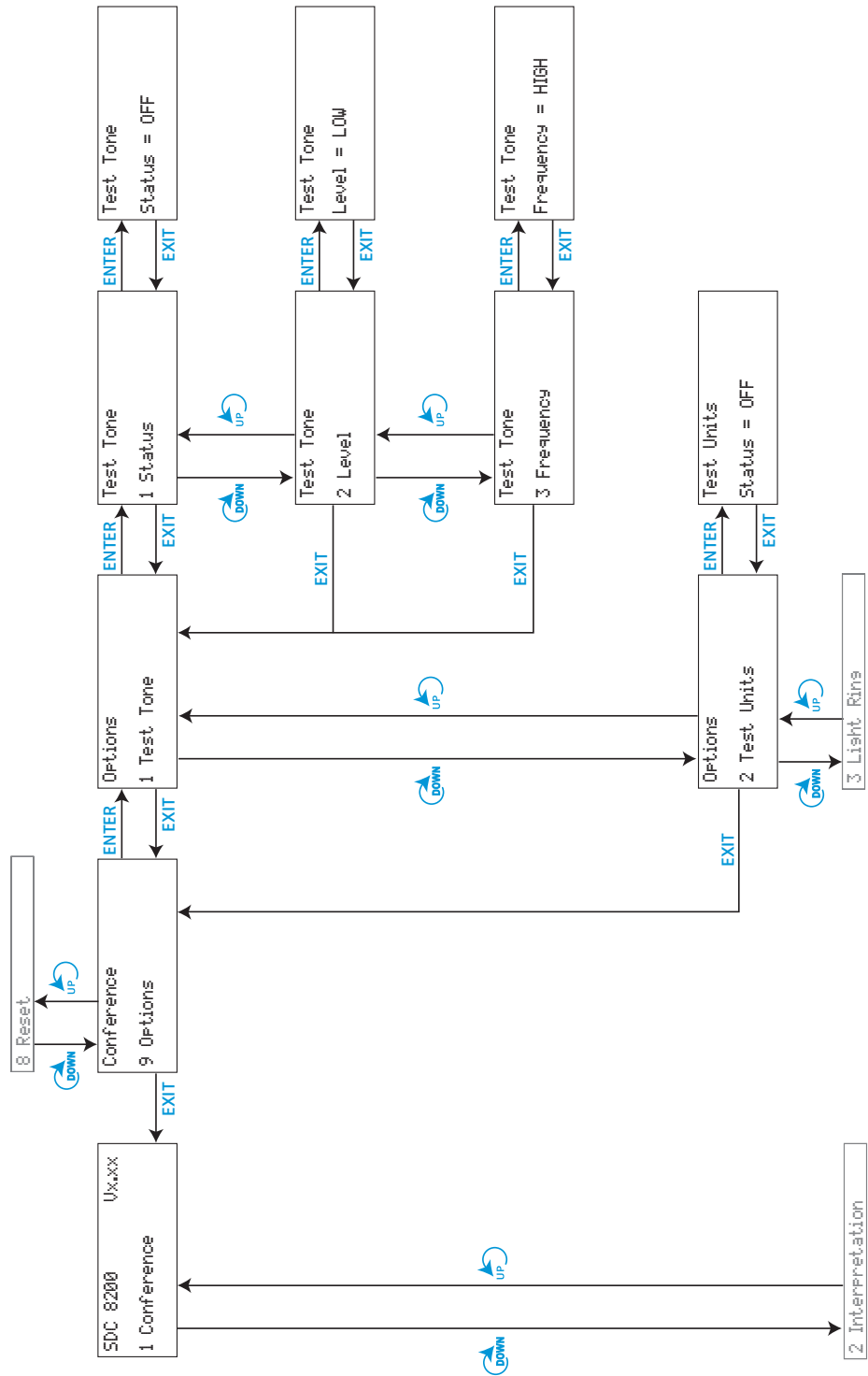

The submenus of the "Conference" menu (part 7 of 7)

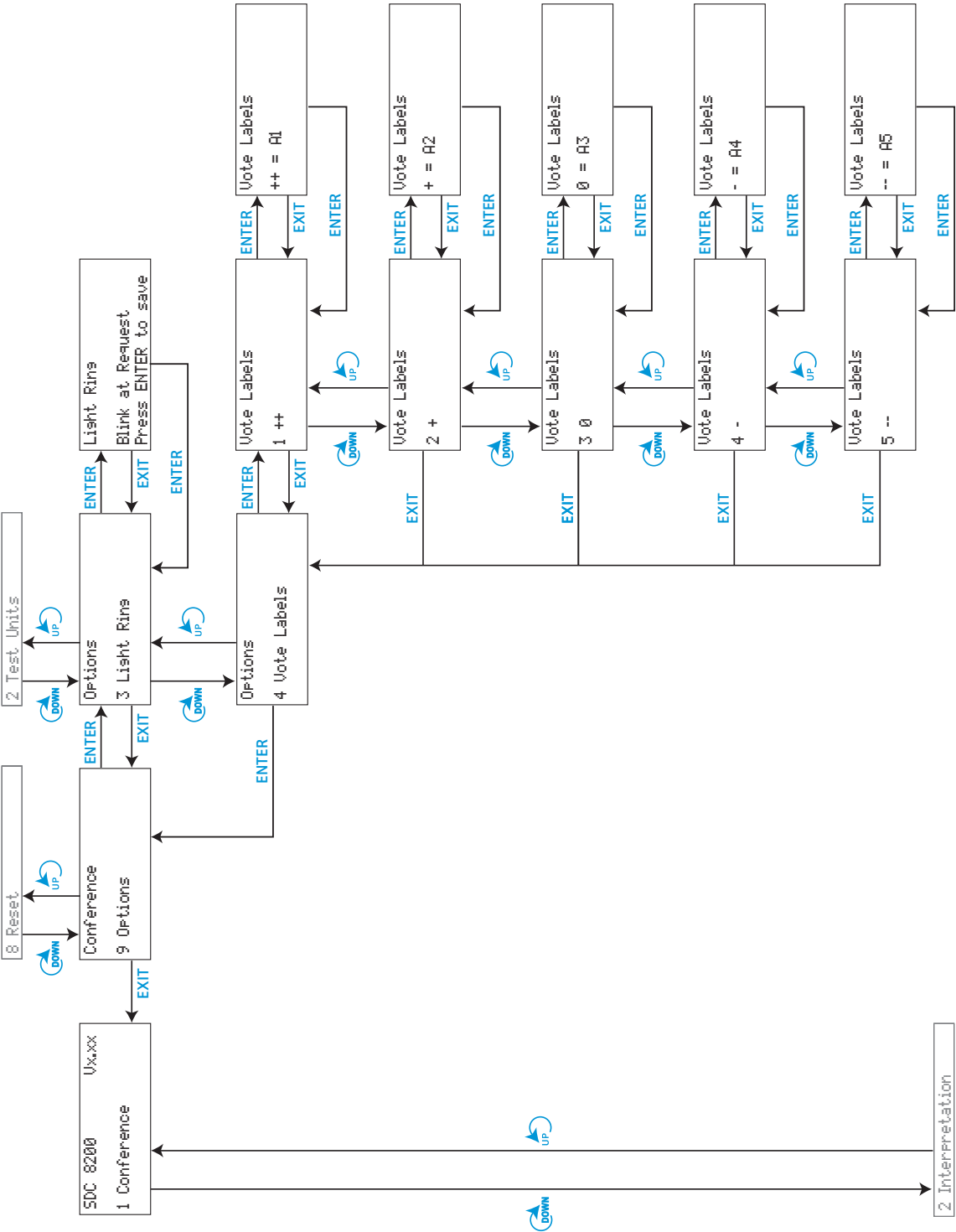

The submenus of the "Interpretation" menu (part 1 of 5)

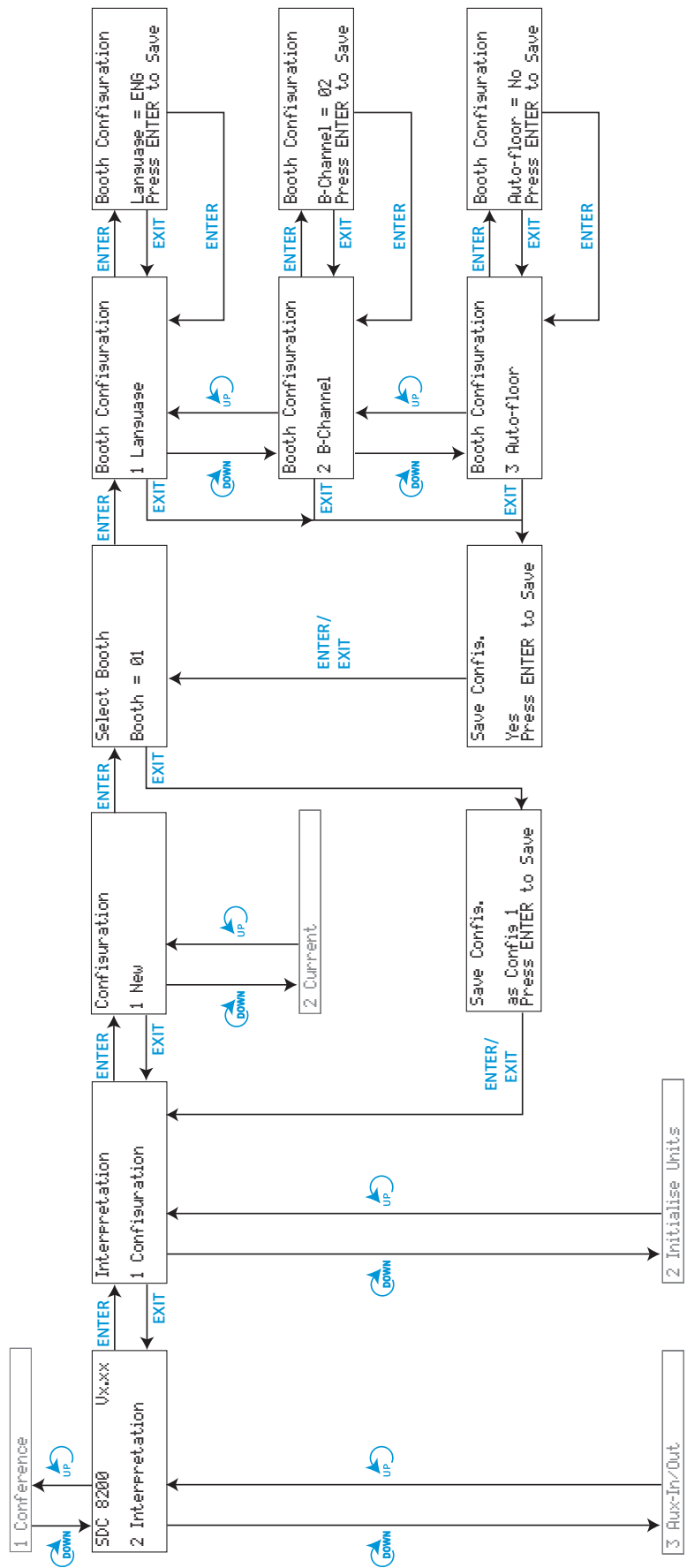

The submenus of the "Interpretation" menu (part 2 of 5)

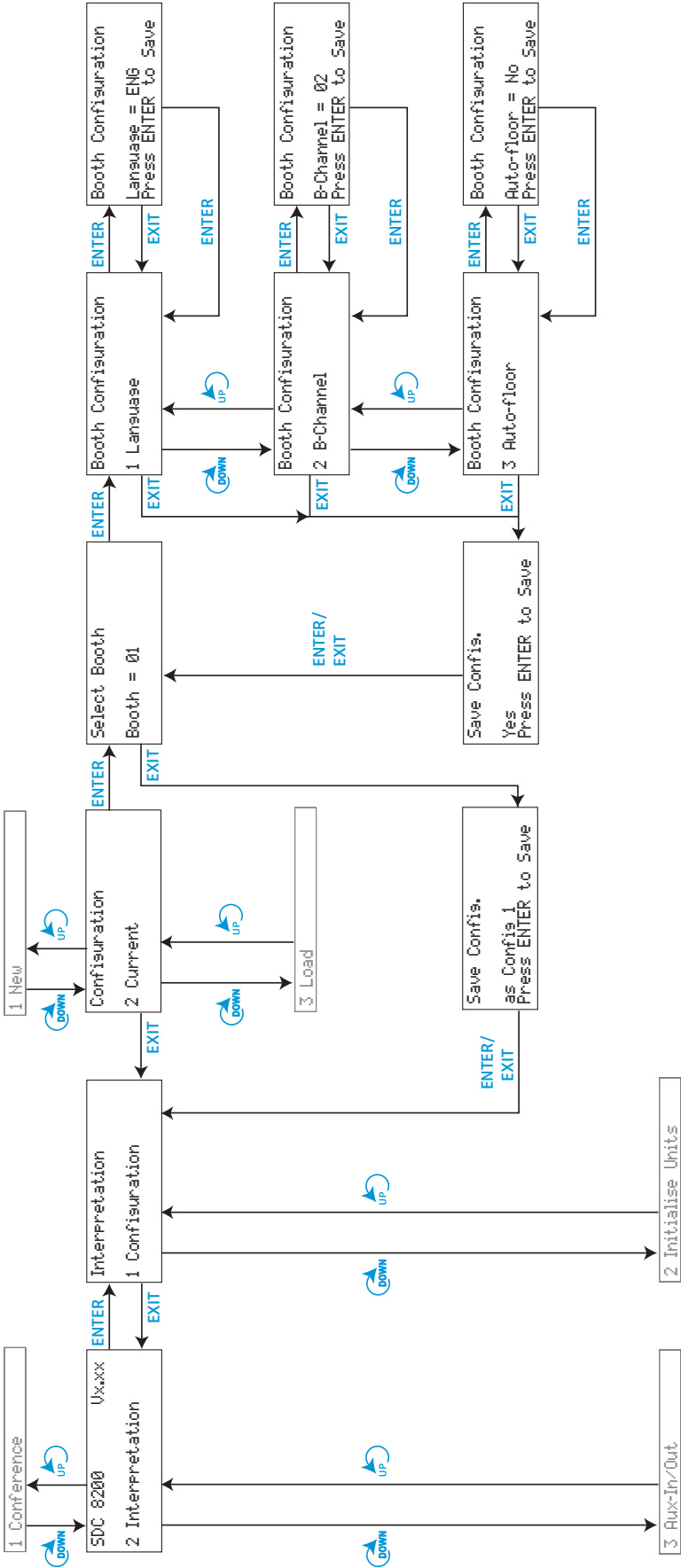

The submenus of the "Interpretation" menu (part 3 of 5)

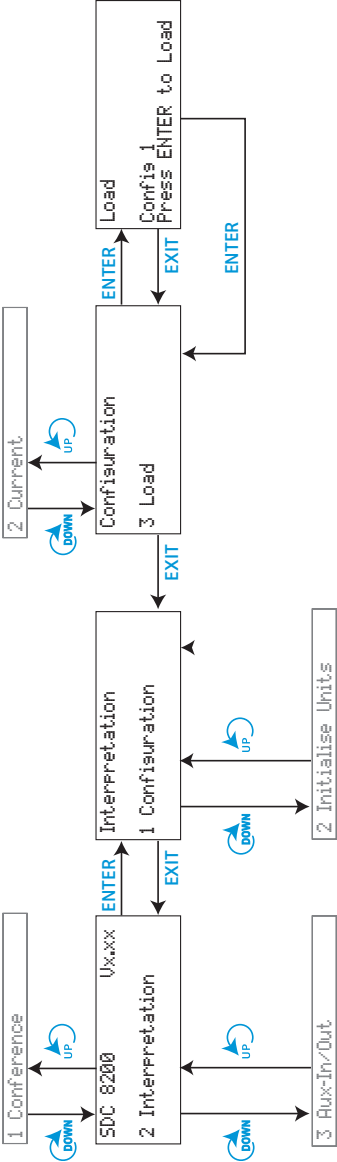

The submenus of the "Interpretation" menu (part 4 of 5)

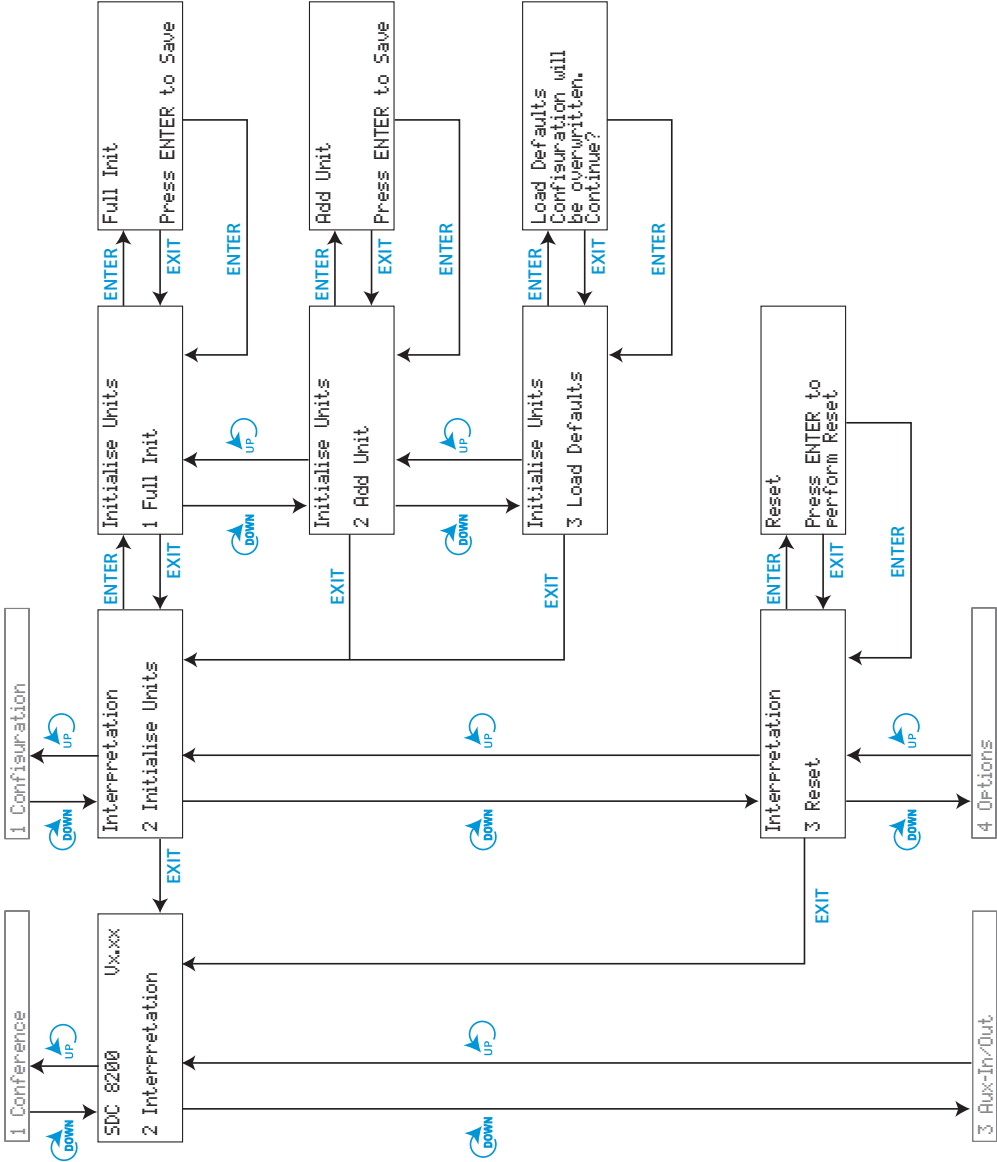

The submenus of the "Interpretation" menu (part 5 of 5)

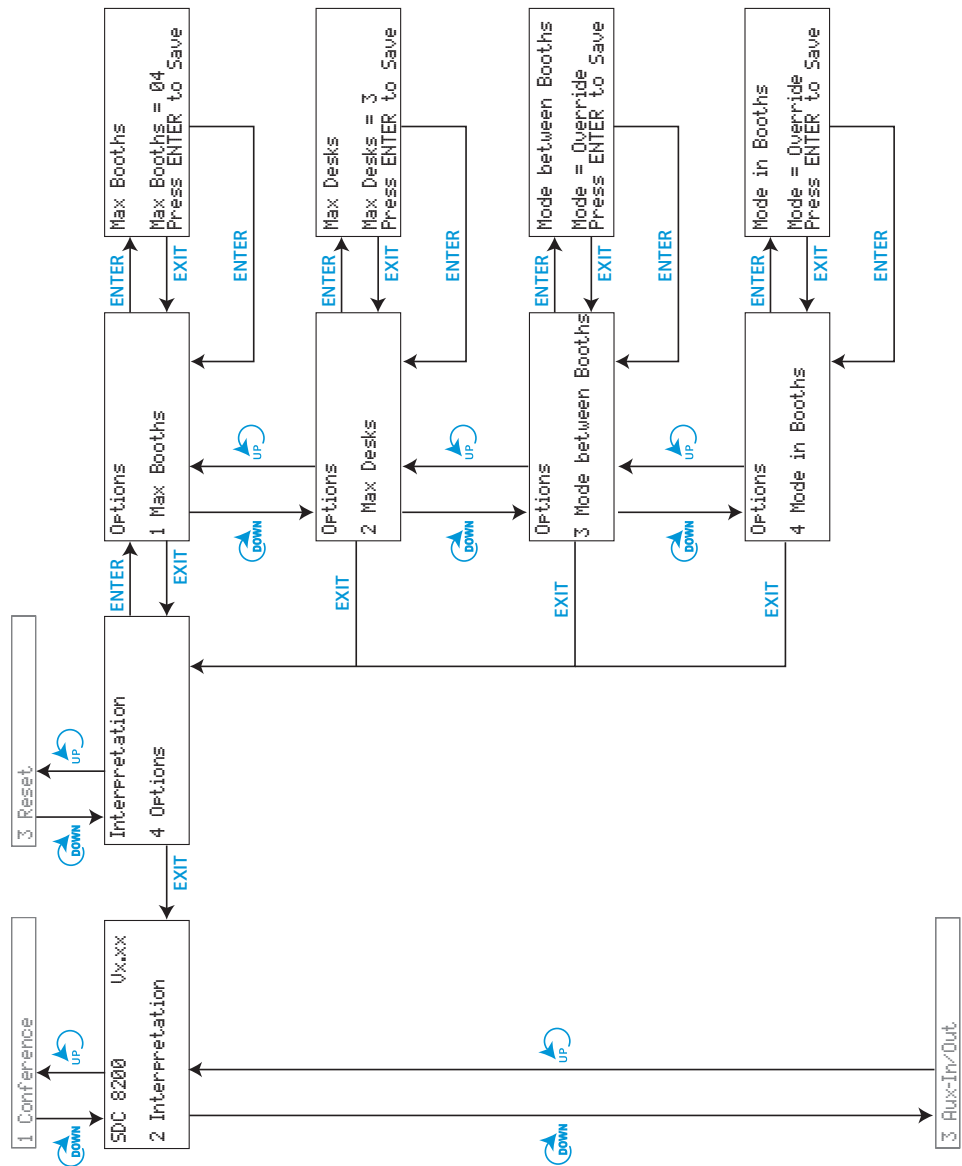

The submenus of the "Aux-In/Out" menu (part 1 of 8)

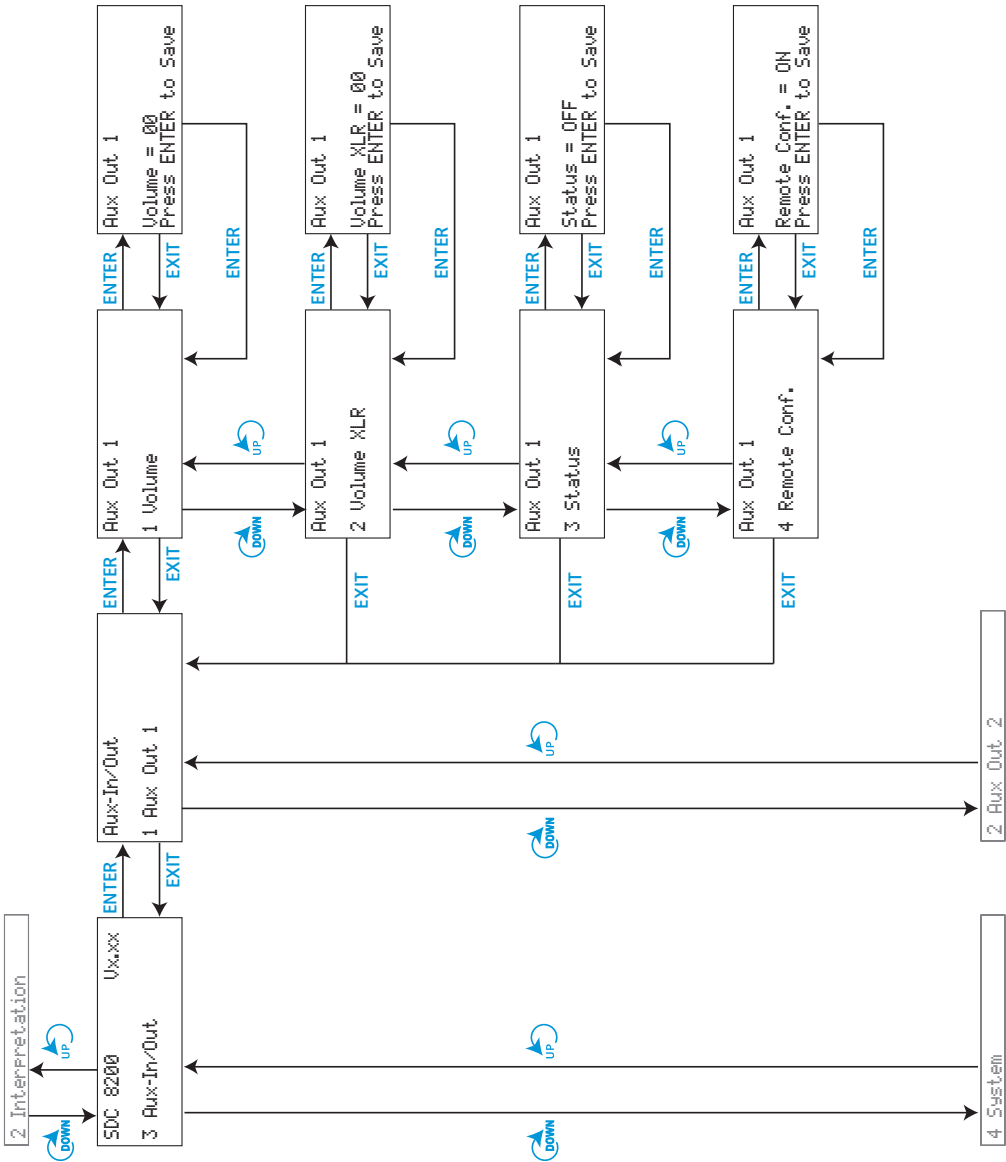

The submenus of the "Aux-In/Out" menu (part 2 of 8)

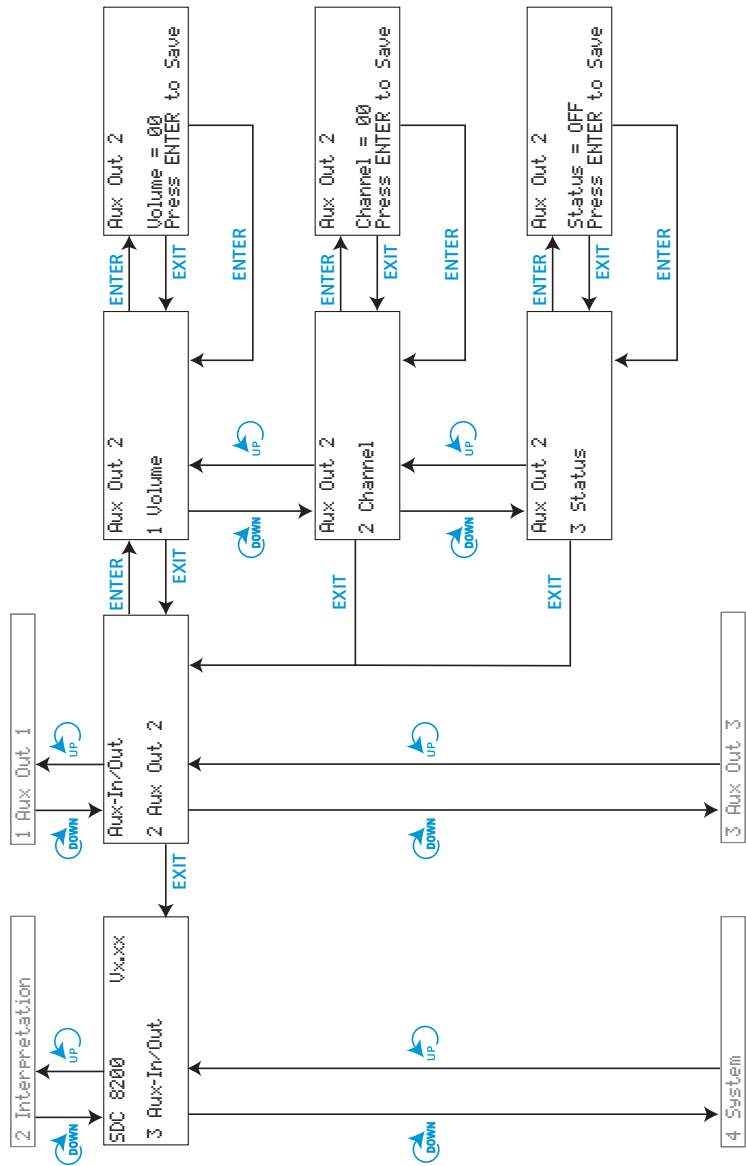

The submenus of the "Aux-In/Out" menu (part 3 of 8)

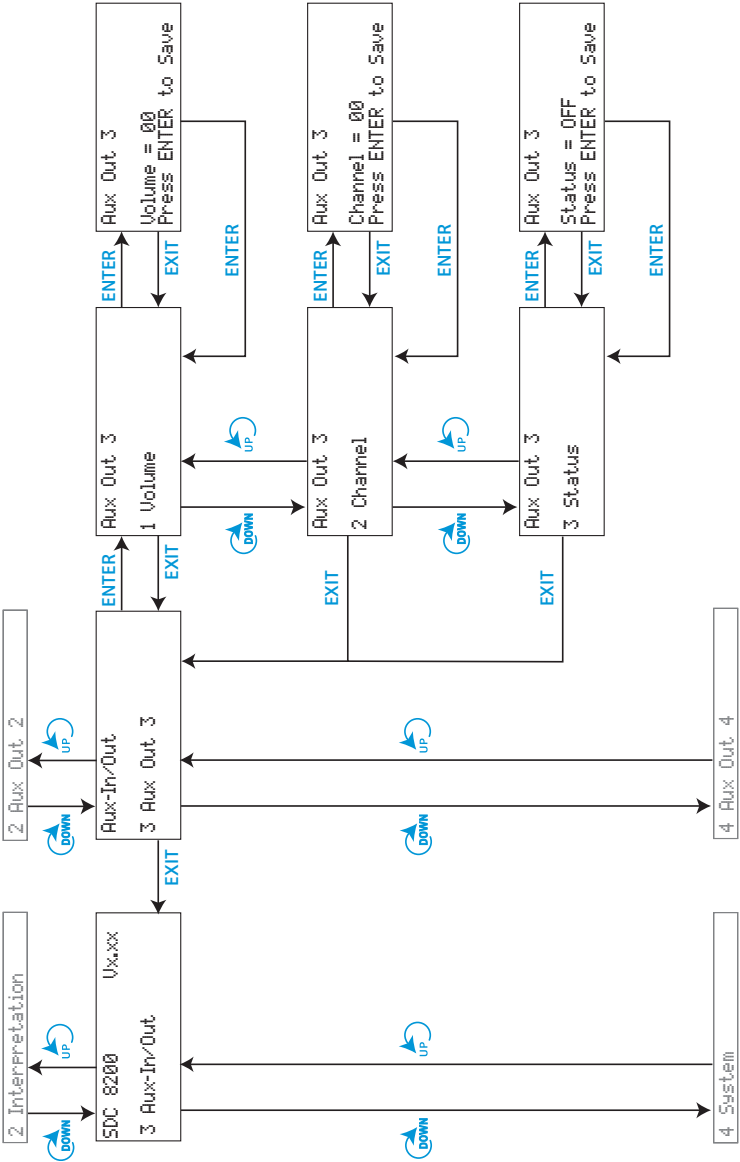

The submenus of the "Aux-In/Out" menu (part 4 of 8)

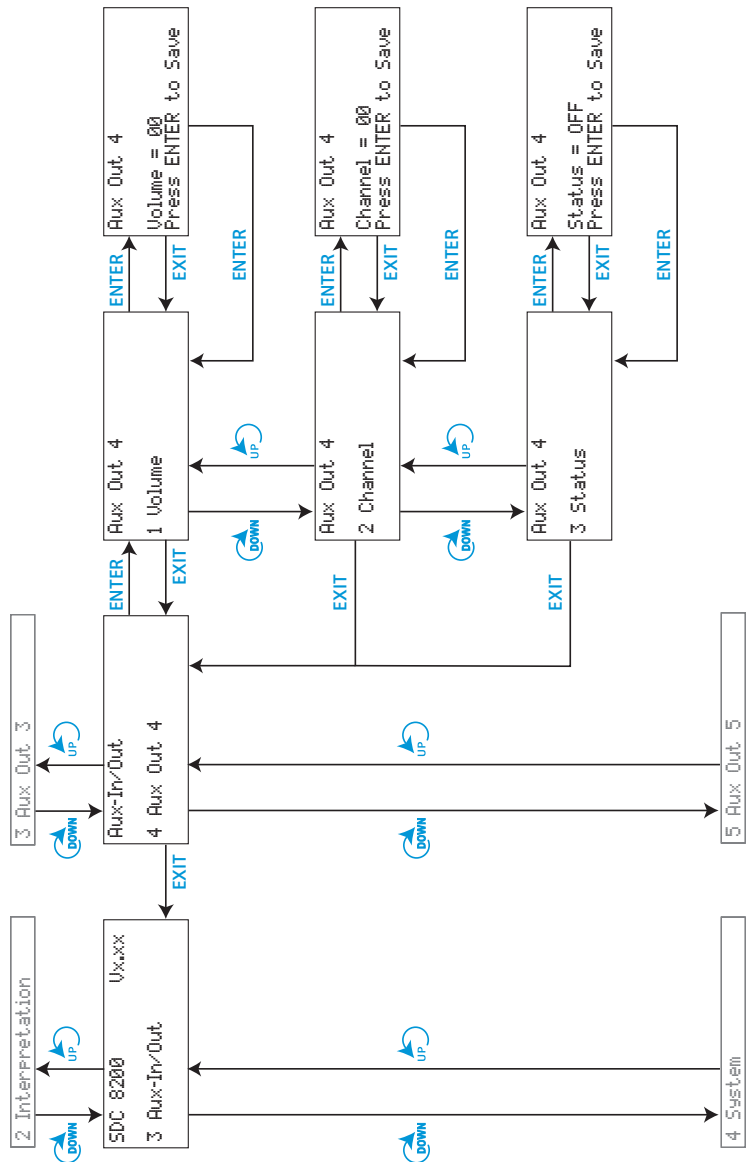

The submenus of the "Aux-In/Out" menu (part 5 of 8)

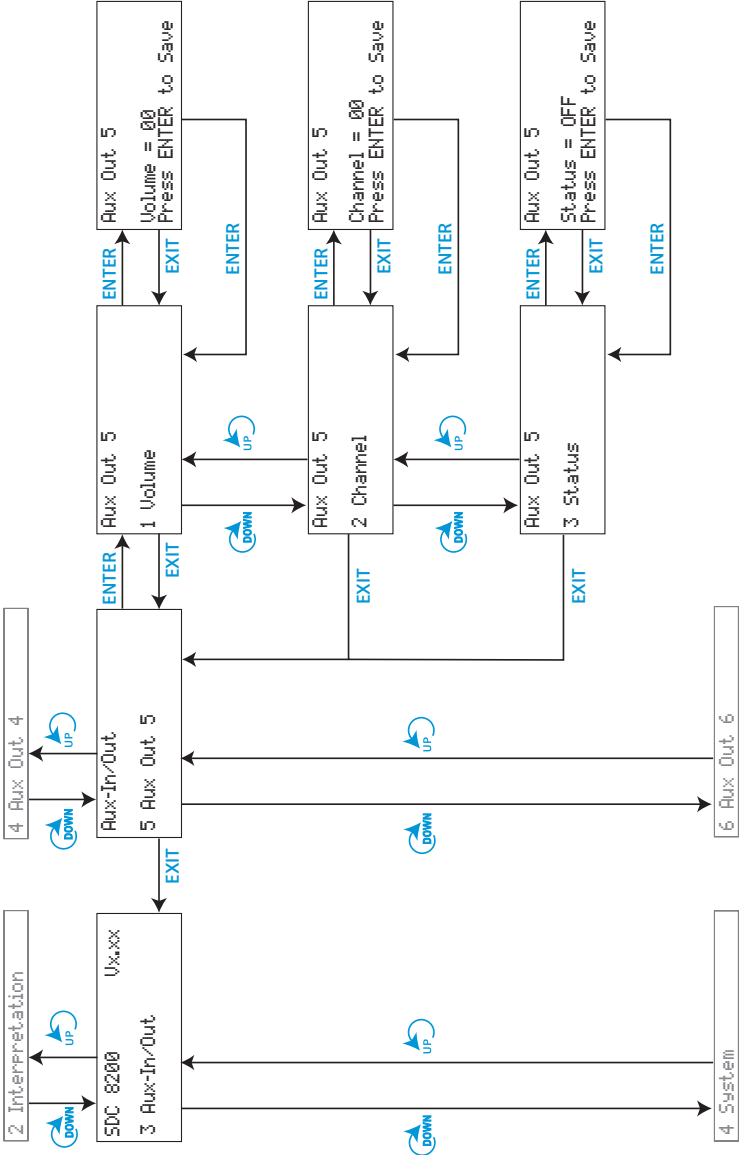

The submenus of the "Aux-In/Out" menu (part 6 of 8)

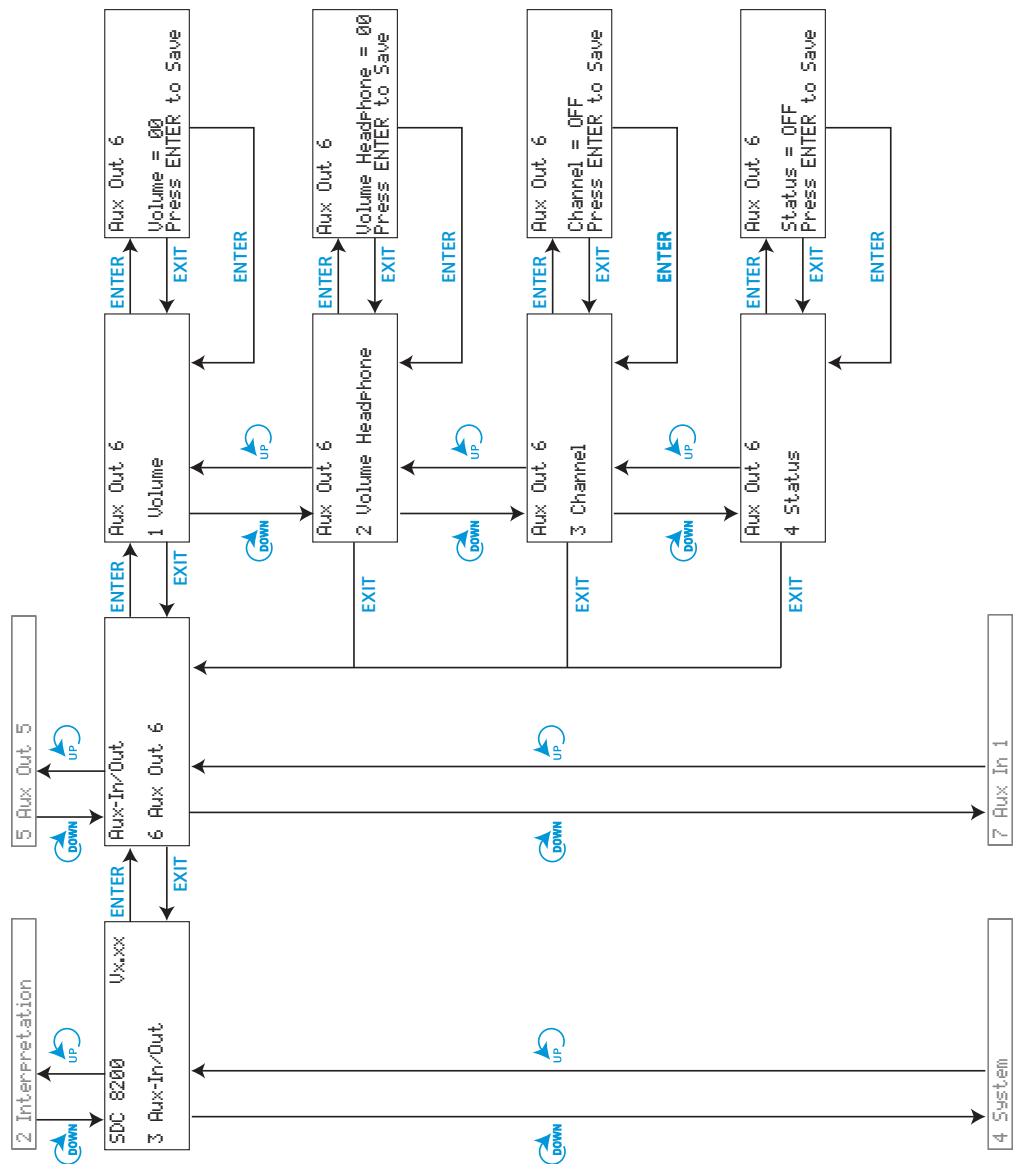

The submenus of the "Aux-In/Out" menu (part 7 of 8)

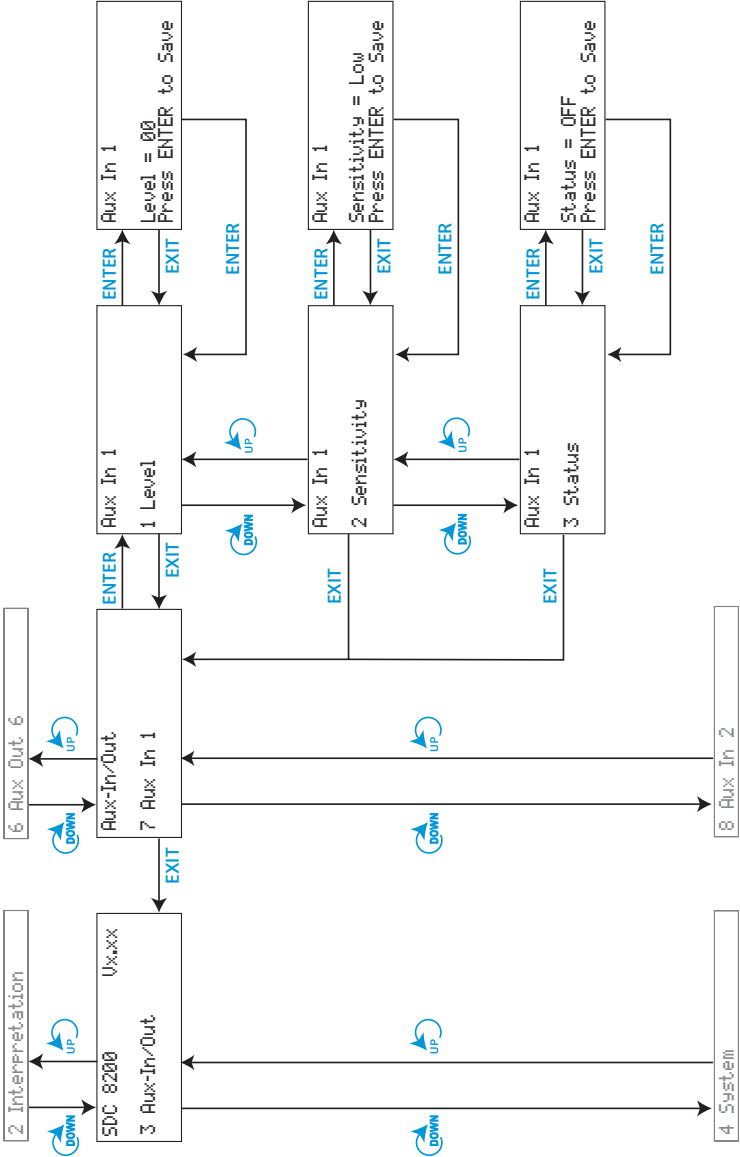

The submenus of the "Aux-In/Out" menu (part 8 of 8)

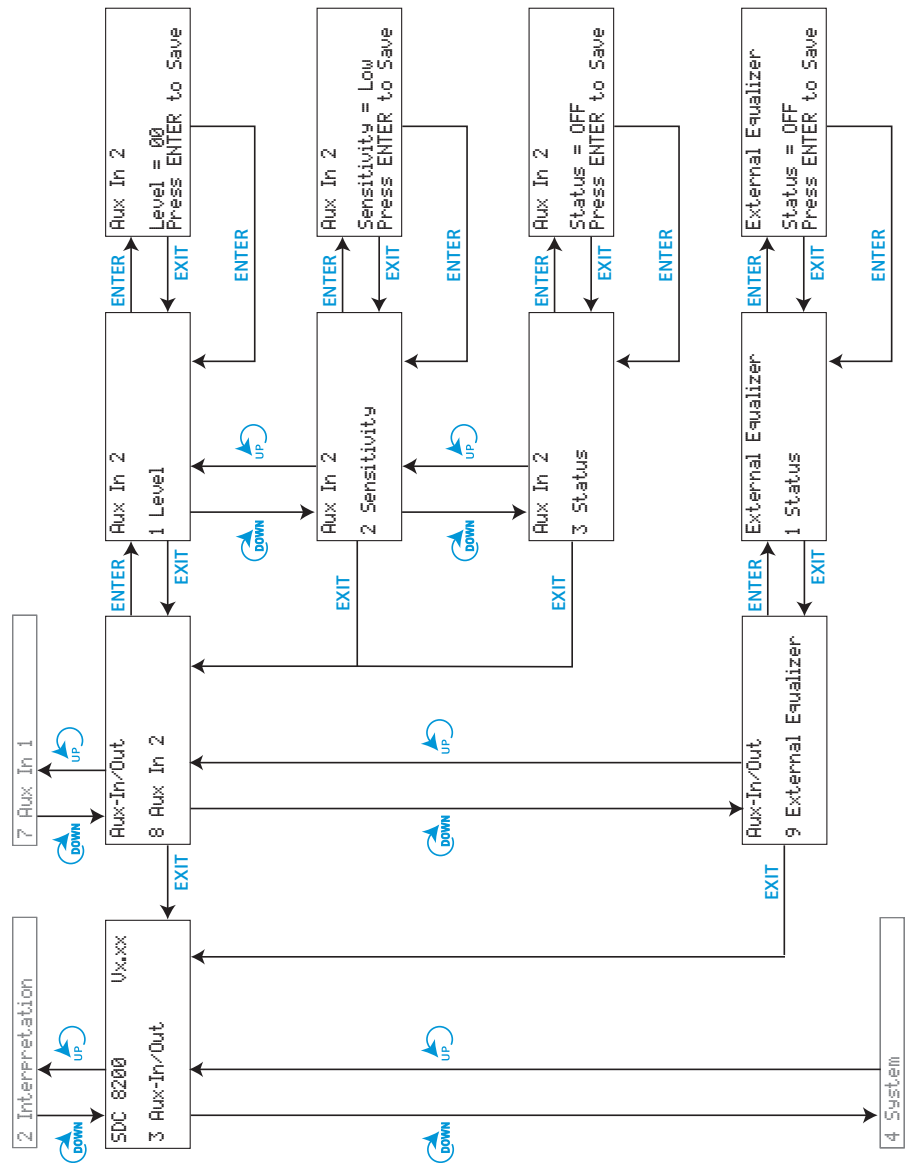

The submenus of the "System" menu (part 1 of 2)

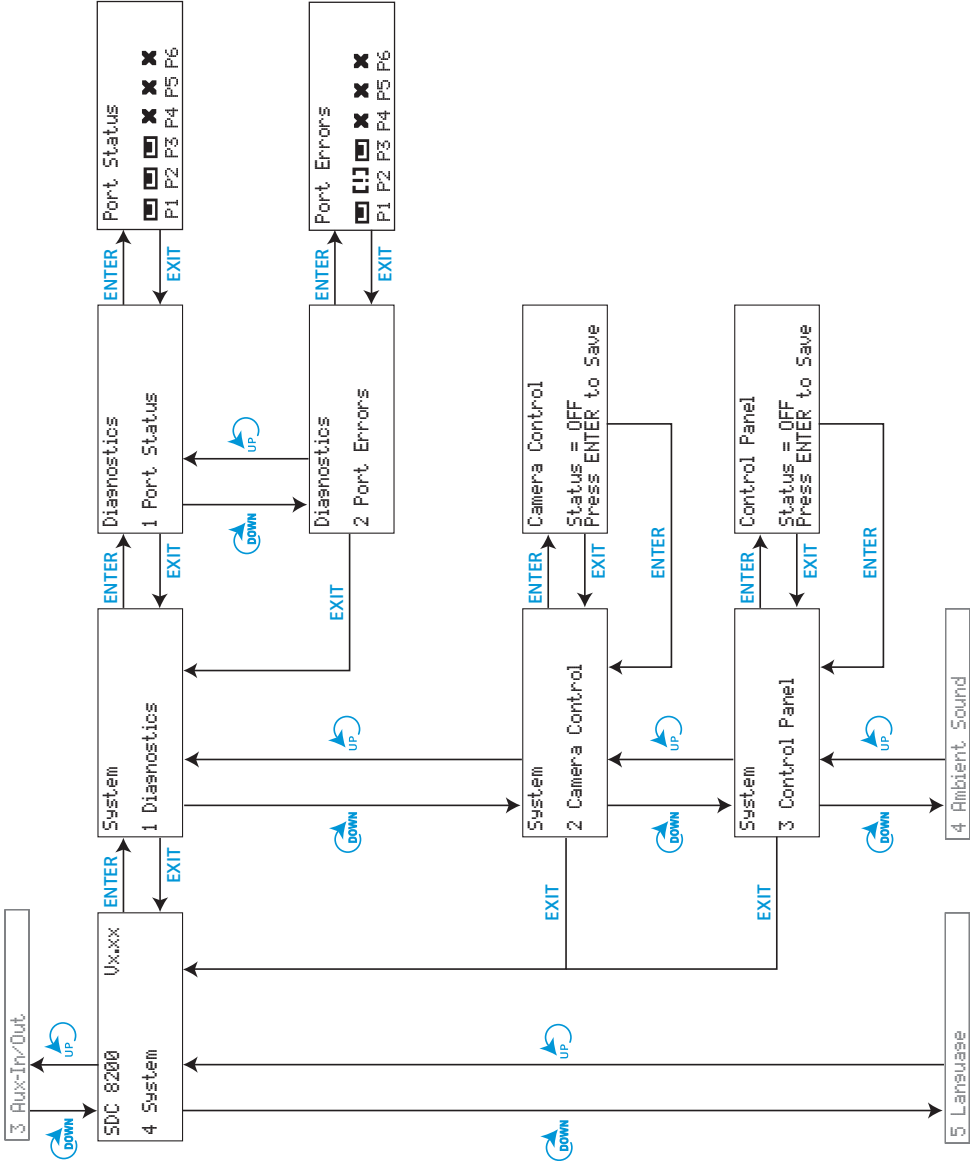

The submenus of the "System" menu (part 2 of 2)

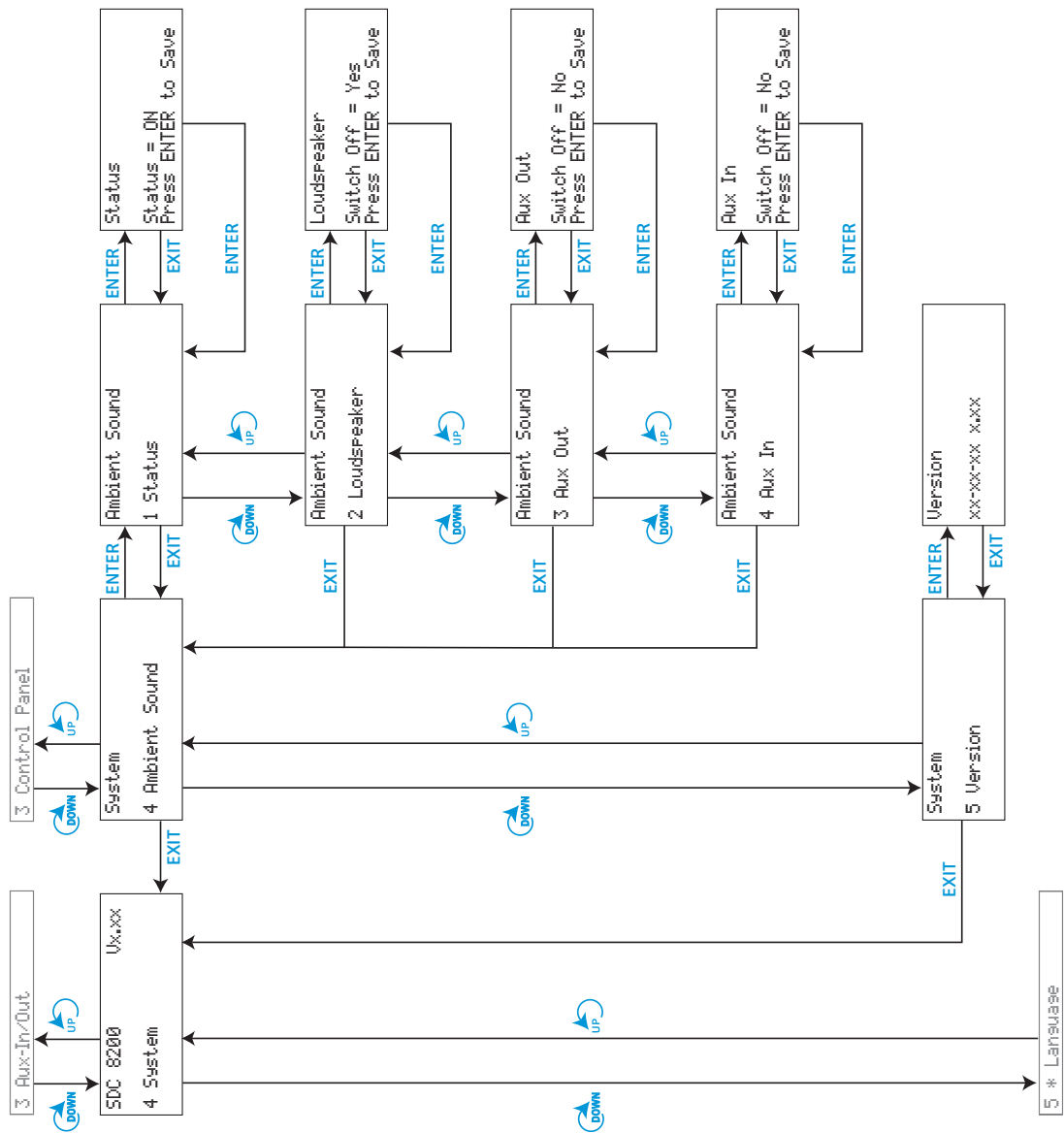

The submenus of the "Language" and the "License" menu (part 1 of 1)

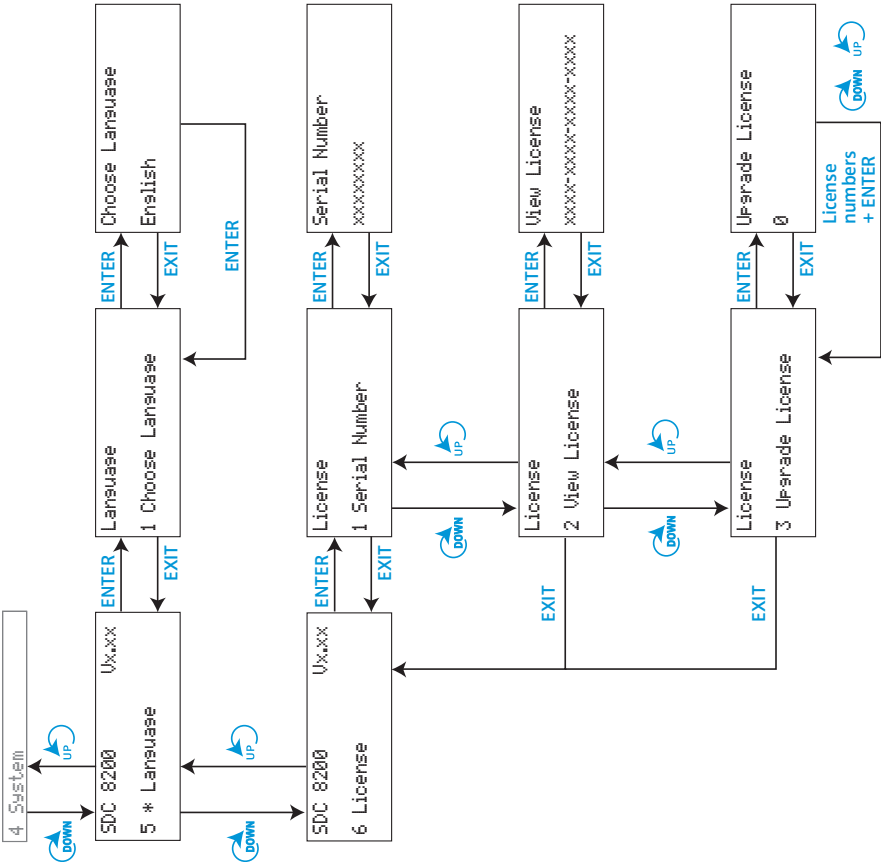

Setting the volume of the consoles' built-in loudspeakers

The bars on the start display indicate the current volume setting for the consoles' built-in loudspeakers.

To set the volume of the consoles' built-in loudspeakers:

```
>Volume = ■■■...
P1 P2 P3 P4 P5 P6
```

- ▶ Turn the jog wheel 4 on the central unit. If you turn the jog wheel clockwise, the volume of the consoles' built-in loudspeakers is increased, if you turn the jog wheel counter-clockwise, the volume is reduced.

Configuring the conference system

Turning on the central unit for the first time

When turning on the central unit for the first time, the text "Init. Refused" is shown on the displays of the conference consoles connected to the central unit. The conference consoles cannot be detected by the central unit, since they have not yet been assigned a microphone number. Your conference system is not yet operational.

```
Conference
7  Initialise Units
```

- ▶ First, initialize the conference consoles in order to assign each console an internal microphone number. You can choose between two initialization modes: automatic and manual initialization.

Note!

Once you have configured your conference and interpretation system, the configuration will be retained in memory on turn-off. When turning on the central unit again, your conference system is immediately operational.

Automatically initializing all conference consoles

The automatic initialization allows you to initialize all conference consoles at once. In this case, however, the consoles are assigned microphone numbers in an arbitrary order.

```
Initialise Units
2  Automatic Init
```

```
Automatic Init
Please wait
```

```
Automatic Init
Press ENTER to
Save Initialisation
```

- ▶ From the central unit's operating menu, choose "Conference", "Initialise Units" and "Automatic Init" one after the other. The text "Please wait" is shown on the display.

- ▶ When the text "Press ENTER to Save Initialisation" is shown on the display, press the ENTER key. All connected conference consoles are initialized automatically and any previous configuration is deleted.

Manually initializing all conference consoles

If it is important that the conference consoles are assigned microphone numbers in a certain order, we recommend choosing the manual initialization.

```
Initialise Units
1   Manual Init
```

- ▶ From the central unit's operating menu, choose "Conference", "Initialise Units" and "Manual Init" one after the other. The red signal light rings 12 and the "Microphone active" LEDs 14 on all conference consoles start flashing.

Note!

Only the signal light rings of the conference consoles start flashing while the signal light rings of the interpreter consoles remain dark! Initialization of the interpreter consoles is via the "Interpretation" menu.

```
Full Init
Press ENTER to Save
```

- ▶ Choose "Full Init".
- ▶ One after the other, press the microphone key $\llcorner \Sigma$ 15 of all conference consoles in the order in which they are to be initialized. As soon as the initialization of a conference console is accepted by the central unit, the red signal light ring of the console goes off.
- ▶ Press the ENTER key to save this configuration.

Loading the factory-preset default configuration for the conference system

If necessary, you can load the factory-preset default configuration for the conference system.

Caution!

Loading the factory-preset default configuration will delete all setting of your current configuration! Your conference system then has to be re-configured to become operational!

To load the factory-preset default configuration for the conference system:

```
Initialise Units
3   Load Defaults
```

- ▶ From the central unit's operating menu, choose "Conference", "Initialise Units" and "Load Defaults" one after the other. The text "Configuration will be overwritten. Continue?" is shown on the display.
- ▶ Press the ENTER key to replace your current configuration by the factory-preset default configuration.

Adding a conference console to an already existing configuration

To add newly connected conference consoles to an already existing configuration:

```
Initialise Units
1   Manual Init
```

- ▶ From the central unit's operating menu, choose "Conference", "Initialise Units" and "Manual Init" one after the other. The red signal light rings 12 and the "Microphone active" LEDs 14 on all conference consoles start flashing.

```
Manual Init
2   Add Unit
```

- ▶ Choose "Add Unit".
Only the signal light rings of the conference consoles not yet initialized remain flashing.
- ▶ Press the microphone key  15 of the conference consoles which you want to add to your configuration.
As soon as the initialization of a conference console is accepted by the central unit, the signal light ring of the console goes off.

```
Initialise Units
1   Manual Init
```

```
Manual Init
3   Delete Unit
```

```
Delete Unit
Mic. Number = 00
Press ENTER to Del.
```

- Removing a conference console from an already existing configuration**
- To remove a conference console from an already existing configuration:
- ▶ From the central unit's operating menu, choose "Conference", "Initialise Units" and "Manual Init" one after the other.
The red signal light rings 12 and the "Microphone active" LEDs 14 on all conference consoles start flashing.
 - ▶ Choose "Delete Unit".
The text "Mic. Number = 00" is shown on the display.
 - ▶ Choose the microphone number of the conference console which you want to delete from your configuration.
The signal light ring of the conference console which is assigned the chosen microphone number remains flashing.
 - ▶ Press the ENTER key.
You can now remove the conference console from the cable string.

```
Initialise Units
1   Manual Init
```

```
Full Init
Press ENTER to Save
```

```
Manual Init
4   Reserve Unit
```

```
Reserve Unit
Mic. Number = 00
Press ENTER to Res.
```

- Reserving a microphone number**
- Before initializing the conference consoles, you can reserve certain microphone numbers for a future configuration, thus making sure that a certain conference console is assigned the desired microphone number.
- To reserve a microphone number:
- ▶ From the central unit's operating menu, choose "Conference", "Initialise Units" and "Manual Init" one after the other.
 - ▶ Choose "Full Init".
All previously "reserved" microphone numbers are deleted.
 - ▶ Press the ENTER key.
The red signal light rings 12 and the "Microphone active" LEDs 14 on all conference consoles start flashing.
 - ▶ Choose "Reserve Unit".
The text "Mic. Number = 00" is shown on the display.
 - ▶ Choose the microphone numbers which you want to reserve and press the ENTER key each time you have chosen a microphone number.
The chosen microphone numbers are reserved.

```

Initialise Units
1   Manual Init

```

```

Delete Unit
Mic. Number = 00
Press ENTER to Del.

```

```

Manual Init
2   Add Unit.

```

To assign a reserved microphone number to a conference console to be added to an already existing configuration:



- ▶ From the central unit's operating menu, choose "Conference", "Initialise Units" and "Manual Init" one after the other. The red signal light rings 12 and the "Microphone active" LEDs 14 on all conference consoles start flashing.
- ▶ Choose "Delete Unit". The text "Mic. Number = 00" is shown on the display.
- ▶ Choose the reserved microphone number and press the ENTER key.
- ▶ Choose "Add Unit". The signal light rings 12 of the conference consoles not yet initialized remain flashing.
- ▶ Press the microphone key  15 of the conference console to which you want to assign the previously reserved microphone number. The newly added conference console is initialized and assigned the previously reserved microphone number.

Selecting a conference mode

By selecting a certain conference mode, you can strongly influence the character of a discussion:

- You determine the level of control of the chairman.
- You determine whether the conference participants can take the floor any time or if they have to "apply" for comments.

Note!

By pressing the microphone key  15 of his or her console, the chairman can take the floor any time, regardless of the conference mode chosen. In addition, he or she can turn off all active microphones – except for the VIP units – by pressing the priority key .

To choose the conference mode:

```

Conference
1   Operating Mode

```

```

Operating Mode
4   Direct Access
Press ENTER to Save

```

- ▶ From the central unit's operating menu, choose "Conference" and "Operating Mode" one after the other. The current conference mode is shown on the display.
- ▶ Choose the desired conference mode and press the ENTER key.

Note!

The selection of the conference mode "No request" only makes sense if your conference and interpretation system is PC controlled. The conference modes "Direct Access", "Fifo", "Group 1" to "Group 4", "Override", "With request" and "With Req. No clear" can also be chosen if your conference and interpretation system is **not** PC controlled.

Setting the speaker limit

You have to set the speaker limit, i.e. the max. number of speakers who can take the floor simultaneously, for the following conference modes:

- "No request"
- "With request"
- "With Req. No clear"
- "Direct Access"
- "Override"

```
Conference
2  Microphone Limit
```

- ▶ From the central unit's operating menu, choose "Conference" and "Microphone Limit" one after the other. The current number is shown on the display.

```
Microphone Limit
Microphone Limit = 4
```

- ▶ Choose the number of speakers who can take the floor simultaneously. The number can be between 1 and 15.
- ▶ Press the ENTER key to save your setting.

Adjusting the audio settings for the consoles' built-in loudspeakers

Via the "Loudspeaker" menu item, you can adjust the audio settings (volume, bass, middle and treble response) for the consoles' built-in loudspeakers.

```
Conference
3  Loudspeaker
```

To change the volume setting:

```
Loudspeaker
1  Volume
```

- ▶ From the central unit's operating menu, choose "Conference", "Loudspeaker" and "Volume" one after the other. The current volume setting is shown on the display.
- ▶ Choose an new volume setting and press the ENTER key to save your setting.

To change the bass response:

```
Loudspeaker
2  Bass
```

- ▶ From the central unit's operating menu, choose "Conference", "Loudspeaker" and "Bass" one after the other. The current setting for the bass response is shown on the display.
- ▶ Change the value and press the ENTER key to save your setting.

To change the middle response:

```
Loudspeaker
3  Middle
```

- ▶ From the central unit's operating menu, choose "Conference", "Loudspeaker" and "Middle" one after the other. The current setting for the middle response is shown on the display.
- ▶ Change the value and press the ENTER key to save your setting.

To change the treble response:

```
Loudspeaker
4  Treble
```

- ▶ From the central unit's operating menu, choose "Conference", "Loudspeaker" and "Treble" one after the other. The current setting for the treble response is shown on the display.
- ▶ Change the value and press the ENTER key to save your setting.

```

Conference
4   Microphones

```

Via the "Microphones" menu item, you can adjust the audio settings (bass, middle and treble response, automatic gain reduction, pick-up area around the microphone) for the consoles' microphones.

```

Microphones
1   Auto LS-Vol. Redu.

```

If several participants speak simultaneously, feedback and loud hissing can occur. In order to prevent feedback, you can activate the automatic gain reduction (Auto LS-Vol. Redu.). This function reduces the gain per active microphone by the selected level and thus prevents feedback.

- ▶ From the central unit's operating menu, choose "Conference", "Microphones" and "Auto LS-Vol. Redu.". The current setting for the gain reduction is shown on the display.
- ▶ Enter the desired gain reduction and press the ENTER key to save your setting.

```

Microphones
5   Limiter Gain

```

The quality of sound reproduction depends on the room acoustics and on the noise around the microphone. If there is a high reverberation level in the room and/or if the ambient noise level is too high, the gain must be reduced (Limiter Gain).

- ▶ From the central unit's operating menu, choose "Conference", "Microphones" and "Limiter Gain". The current setting in dB is shown on the display.
- ▶ Enter the desired value and press the ENTER key to save your setting.

To change the bass response:

```

Microphones
2   Bass

```

- ▶ From the central unit's operating menu, choose "Conference", "Microphones" and "Bass" one after the other. The current setting for the bass response is shown on the display.
- ▶ Change the value and press the ENTER key to save your setting.

To change the middle response:

```

Microphones
3   Middle

```

- ▶ From the central unit's operating menu, choose "Conference", "Microphones" and "Middle" one after the other. The current setting for the middle response is shown on the display.
- ▶ Change the value and press the ENTER key to save your setting.

To change the treble response:

```

Microphones
4   Treble

```

- ▶ From the central unit's operating menu, choose "Conference", "Microphones" and "Treble" one after the other. The current setting for the treble response is shown on the display.
- ▶ Change the value and press the ENTER key to save your setting.

```
Set Chairmen
01 = 0000
```

```
Set Chairmen
01 = 0000
```

Configuring additional chairman units (Chairmen)

After initialization, the central unit determines one chairman unit. To configure additional chairman units (up to a maximum of 50 consoles), proceed as follows:

- ▶ From the central unit's operating menu, choose "Conference", "Chairmen" and "Set Chairman" one after the other. The list number 01 (list numbers are from 01 to 50) is highlighted in black.
- ▶ Choose the desired list number and press the ENTER key. The placeholder (0000) for the microphone number is highlighted in black.
- ▶ Enter the microphone number of the conference console which you want to configure as chairman unit.
- ▶ Press the ENTER key to save your setting.

Note!

If your conference and interpretation system is PC controlled, the settings for the chairman units made on the central unit are overwritten by the settings made in the software control. If the conference system is reinitialized, the list of chairman units is deleted.

Deleting the list of chairman units (Chairmen)

You can delete the list of configured chairman units in order to configure other conference consoles as chairman units.

```
Chairmen
2 Clear Chairmen
```

- ▶ From the central unit's operating menu, choose "Conference", "Chairmen" and "Clear Chairman" one after the other. The text "Configuration will be overwritten. Continue?" is shown on the display.
- ▶ Press the ENTER key. The list of chairman units is deleted.

Configuring additional VIP units (VIP)

After initialization, the central unit determines one VIP unit. To configure additional VIP units (up to a maximum of 50 consoles), proceed as follows:

```
Set VIP
01 = 0000
```

```
Set VIP
01 = 0000
```

- ▶ From the central unit's operating menu, choose "Conference", "VIP" and "Set VIP" one after the other. The list number 01 (list numbers are from 01 to 50) is highlighted in black.
- ▶ Choose the desired list number and press the ENTER key. The placeholder ("0000") for the microphone number is highlighted in black.
- ▶ Enter the microphone number of the conference console which you want to configure as VIP unit.
- ▶ Press the ENTER key to save your setting.

Note!

If your conference and interpretation system is PC controlled, the settings for the VIP units made on the central unit are overwritten by the settings made in the software control. If the conference system is reinitialized, the list of VIP units is deleted.

```
VIP
2   Clear VIP
```

Deleting the list of VIP units (VIP)

You can delete the list of configured VIP units in order to configure other conference consoles as VIP units.

- ▶ From the central unit's operating menu, choose "Conference", "VIP" and "Clear VIP" one after the other.
The text "Configuration will be overwritten. Continue?" is shown on the display.
- ▶ Press the ENTER key.
The list of VIP units is deleted.

```
VIP
3   Status
```

```
VIP
Status = ON
Press ENTER to Save
```

```
Conference
6   Reset
```

Activating/deactivating the special rights of the VIP units (VIP)

You can activate ("ON") or deactivate ("OFF") the special rights of the VIP units.

- ▶ From the central unit's operating menu, choose "Conference", "VIP" and "Status" one after the other.
The current status ("ON" or "OFF") is shown on the display.
- ▶ Change the status and press the ENTER key to save your setting.
The special rights of the VIP units are activated or deactivated.

Resetting the conference system (Reset)

To reset the conference system:

- ▶ From the central unit's operating menu, choose "Conference" and "Reset" one after the other.
- ▶ Press the ENTER key.
The conference system is reset.

Note!

Resetting the conference system has no effect on the interpretation system.

Testing the consoles' built-in loudspeakers

Via the "Test Tone" menu item, you can check if the consoles are connected correctly and if the consoles' built-in loudspeakers are working correctly.

To activate the test tone:

```
Options
1   Test Tone
```

- ▶ From the central unit's operating menu, choose "Conference", "Options" and "Test Tone" one after the other.
- ▶ Choose "Status = ON".
All loudspeakers produce the test tone.
- ▶ To change the volume of the test tone, choose "Level". You can choose between "High" and "Low".
- ▶ To change the frequency of the test tone, choose "Frequency". You can choose between "High" and "Low".
- ▶ To deactivate the test tone, choose "Status = OFF" and press the ENTER key.
The test tone is deactivated.

Testing the consoles' microphones



Via the "Test Units" menu item, you can check if the consoles' microphones are working correctly

To activate the microphones:

```
Options
2   Test Units
```

- ▶ From the central unit's operating menu, choose "Conference", "Options" and "Test Units" one after the other.
- ▶ Choose "Status = ON".
- ▶ All microphones are activated one after the other in the order in which the consoles were initialized. The red signal light ring of the currently active microphone lights up. After all microphones have been activated once, activation re-starts with the first microphone.

Activating/deactivating the flashing of the signal light ring

If – in "With Request" or "With Req. No Clear" mode – a participant presses the microphone key  on his console, he makes a request to speak and the green "Request to speak" LED  starts flashing.

To activate the flashing of the signal light ring on all consoles:

```
Options
3   Light Ring
```

- ▶ From the central unit's operating menu, choose "Conference", "Options" and "Light Ring" one after the other.
- ▶ Choose "Blink in Request." and press the ENTER key.
If a participant makes a request to speak, the red signal light ring and the green "Request to speak" LED  on his console start flashing.

To deactivate the flashing of the signal light ring on all consoles:

- ▶ Choose "OFF".
If a participant makes a request to speak, only the green "Request to speak" LED  on his console starts flashing.

Configuring the display of the voting options

If the conference manager or chairman starts a voting session, the voting options are shown on the displays of all conference consoles:

```
MIC N.: 0001
      VOTE 1 OF 3
      +   0   -
```

```
MIC N.: 0001
      VOTE 1 OF 5
      ++  +   0   ---
```

To change the indication of the voting options:

```
Options
4   Vote Labels
```

- ▶ From the central unit's operating menu, choose "Conference", "Options" and "Vote Labels" one after the other.
- ▶ Choose the voting option whose indication you want to change („1 ++", "2 +", "3 0", "4 -" or "5 ---") and press the ENTER key.
- ▶ Use the jog wheel to select the first character of the voting option and press the ENTER key.
- ▶ In the same way, select and enter the second and third character of the voting option. You can enter a maximum of three characters. If you wish to enter less than three characters, you have to enter a space instead of a character.

Configuring the interpretation system

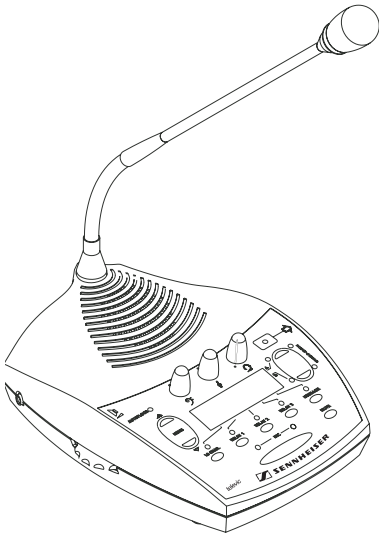

Apart from the conference system, the SDC 8200 system comprises a separate interpretation system. To be able to make use of the interpretation system, you require the SDC 8200 ID interpreter consoles.

Via the "Interpretation" menu, you can quickly and easily configure the interpretation system.

Working with the interpreter configuration

The following features of your interpretation system are put together in an interpreter configuration:

- The number of booths and the number of interpreter consoles per booth (see "Setting the max. number of interpreter booths/languages" on page 98 und "Setting the max. number of interpreter consoles per booth" on page 98).
- The operating modes between booths and within booths (see "Configuring the operating mode between booths" on page 98 and "Configuring the operating mode within a booth" on page 99).
- The main target languages of the respective booths (see "Configuring the main target language (A-channel) of a booth" on page 100).
- The second target languages of the respective booths (see "Configuring the second target language (B-channel) of a booth" on page 100).
- The booth from which a relay interpretation is delivered (see "Enabling the auto-relay interpretation function (Auto-floor)" on page 101).
- The initialization of the interpreter consoles (see "Half-automatically initializing all interpreter consoles on the central unit" on page 101).

You can save two different interpreter configurations in the central unit: "CONFIG 1" and "CONFIG 2". This allows you to quickly and easily adapt you interpretation system to a new conference. In addition, you can modify the currently active interpreter configuration at any time.

Creating a new interpreter configuration

To create a new interpreter configuration:

1. Define the number of booths as described under "Setting the max. number of interpreter booths/languages" on page 98.
If you change the number of booths after you have created and saved the interpreter configuration, the new number of booths will automatically be saved in the configuration.
2. Define the number of interpreter consoles per booth as described under "Setting the max. number of interpreter consoles per booth" on page 98.
If you change the number of interpreter consoles after you have created and saved the interpreter configuration, the new number of interpreter consoles will automatically be saved in the configuration.
3. From the central unit's operating menu, choose "Conference", "Configuration" and "New" one after the other.
The "Select Booth" menu appears.
4. (Carry out this step once for each booth.)
Choose the booth number and configure:
 - the main target language as described under "Configuring the main target language (A-channel) of a booth" on page 100.

```
Configuration
```

```
1    New
```

```
Select Booth
```

```
Booth = 01
```

```
Save Confis.
as Confis. 1
Press ENTER to Save
```

- – if necessary – the second target language as described under “Configuring the second target language (B-channel) of a booth” on page 100.
 - – if necessary – the auto-relay interpretation for the interpreters as described under “Enabling the auto-relay interpretation function (Auto-floor)” on page 101.
5. After you have configured the last booth, press the EXIT key repeatedly until the “Save Confis.” menu appears.
 6. Choose “as Confis 1” or “as Confis 2” and press the ENTER key. The interpreter configuration is saved.

Caution!

If you exit the “Save Confis.” menu by pressing the EXIT key, the interpreter configuration will **not** be saved! A new interpreter configuration is not created.

7. Initialize all interpreter consoles on the central unit (see “Half-automatically initializing all interpreter consoles on the central unit” on page 101). This initialization is automatically added to the existing configuration. Your interpretation system is now ready for operation.

Modifying the currently active interpreter configuration

You can modify the following features of the currently active interpreter configuration:

- the main target language (A-channel)
- the second target language (B-channel)
- the auto-relay interpretation for the interpreters (auto-floor)

To modify the currently active interpreter configuration:

```
Confisuration
Current
```

```
Select Booth
Booth = 01
```

1. From the central unit’s operating menu, choose “Conference”, “Confisuration” and “Current” one after the other. The “Select Booth” menu appears.
2. (Carry out this step once for each booth.) Choose the booth number and modify:
 - the main target language as described under “Configuring the main target language (A-channel) of a booth” on page 100.
 - – if necessary – the second target language as described under “Configuring the second target language (B-channel) of a booth” on page 100.
 - – if necessary – the auto-relay interpretation for the interpreters as described under “Enabling the auto-relay interpretation function (Auto-floor)” on page 101.

```
Save Confis.
as Confis 1
Press ENTER to Save
```

3. After you have configured the last booth, press the EXIT key repeatedly until the "Save Confis." menu appears.
4. Choose "as Confis 1" or "as Confis 2" and press the ENTER key. The modified interpreter configuration is saved and becomes effective immediately.

Caution!

If you exit the "Save Confis." menu by pressing the EXIT key, the interpreter configuration will **not** be saved! The existing interpreter configuration remains unchanged!

Loading a previously saved interpreter configuration

To load a previously saved interpreter configuration:

```
Configuration
3 Load
```

- ▶ From the central unit's operating menu, choose "Conference", "Configuration" and "Load" one after the other. The "Load" menu appears.
- ▶ Choose "Configuration 1" or "Configuration 2" and press the ENTER key. The interpreter configuration is loaded. Since the options and the initialization of the interpreter consoles on the central unit have already been saved in this interpreter configuration, your interpretation system is immediately operational. It is therefore not necessary to initialize the interpreter consoles again.

Caution!

If – after having loaded an interpreter configuration – you have to reinitialize the interpreter consoles, for example because you had to remove or add consoles, it is vital to reset the interpretation system!

Options

```
Interpretation
4 Options
```

The "Options" menu item on the "Interpretation" menu allows you to configure the basic features of your interpretation system:

- The max. number of interpreter booths or languages
- The max. number of interpreter consoles per booth
- The operating mode between the interpreter booths
- The operating mode within the interpreter booths

You can connect a total of 28 booths with up to eight interpreter consoles each to a single central unit SDC 8200 CU, i.e. you can realize an interpretation system with up to 224 interpreter consoles.

```
Options
1   Max Booths
```

Setting the max. number of interpreter booths/languages

You have to configure an interpreter booth for each language offered:

- ▶ From the central unit's operating menu, choose "Interpretation", "Options" and "Max Booths" one after the other. The current number of booths is shown on the display.
- ▶ Set the max. number of booths/languages for your interpretation system and press the ENTER key to save your setting.

Note!

The maximum number of configurable languages also depends on your license. The configuration of four languages is license-free. In order to be able to configure more than four languages, you have to purchase one of the language licenses available (see "Licenses for expanding the SDC 8200 CU central unit" on page 117).

Example:

Let us assume that the active languages at a conference are English, German and French. You then have to configure your system so that it comprises an "English" booth, a "German" booth and a "French" booth.

```
Options
2   Max Desks
```

Setting the max. number of interpreter consoles per booth

To set the max. number of interpreter consoles per booth:

- ▶ From the central unit's operating menu, choose "Interpretation", "Options" and "Max Desks" one after the other. The current number of interpreter consoles is shown on the display.
- ▶ Set the desired number of interpreter consoles and press the ENTER key to save your setting.

Example:

Let us assume that the active languages at a conference are English, German and French and that two interpreters are available for each language. You then have to configure your system so that it comprises three interpreter booth with two interpreter consoles each.

Configuring the operating mode between booths

To determine whether or not interpreter consoles installed in different booths but configured to the same target language can be simultaneously active:

```
Options
3   Mode between Booth
```

```
Mode between Booths
Mode = Override
Press ENTER to Save
```

- ▶ From the central unit's operating menu, choose "Interpretation", "Options" and "Mode between Booth" one after the other. The current mode is shown on the display.
- ▶ Choose the desired mode. You can choose between the modes "Mixed", "Override" and "Toggle Override".
 - Choose "Mixed" if interpreters in different booths interpret into the same target language and work in turns. When two interpreters simultaneously interpret into the same

language, the red signal light ring 12 and the “Microphone active” LED 14 on their consoles light up.

- Choose “Override” if activating an interpreter console in another booth turns off the currently active interpreter console. The interpreter console that was just turned off can only be turned on again if the interpreter console by which it was turned off is deactivated.
- Choose “Toggle Override” if activating an interpreter console in another booth turns off the currently active interpreter console. The interpreter console that was just turned off can be turned on again any time by pressing the MIC key 15.

▶ Press the ENTER key to save your setting.

Configuring the operating mode within a booth

To determine whether or not the interpreter consoles installed within a booth can be simultaneously active:

```
Options
4   Mode in Booths
```

```
Mode in Booths
Mode = Mixed
Press ENTER to Save
```

▶ From the central unit’s operating menu, choose “Interpretation”, “Options” and “Mode in Booths” one after the other. The current mode is shown on the display.

▶ Choose the desired mode.

You can choose between the modes “Mixed” and “Toggle Override”.

- Choose “Mixed” if several interpreters in the same booth interpret into the same language. When two interpreters simultaneously interpret into the same language, the red signal light ring 12 and the “Microphone active” LED 14 on their consoles light up.
- Choose “Toggle Override” if activating another interpreter console within a booth turns off the currently active interpreter console. The interpreter console that was just turned off can be turned on again any time by pressing the MIC key 15.

Configuring the language options for the interpreter booths

The “Configuration” menu item on the “Interpretation” menu allows you to configure the language options for the interpreter booths:

- the main target language (A-channel)
- the second target language (B-channel)
- the auto-relay interpretation for the interpreters (auto-floor)

```
Interpretation
1   Configuration
```

```
Save Confis.
Yes
Press ENTER to Save
```

▶ After having configured the language options as described in the following sections, press the EXIT key to get to the display shown on the left.

▶ Press the ENTER key to save your configuration and to exit the “Booth Configuration” menu.

Configuring the main target language (A-channel) of a booth

To configure the main target language of a booth:

- ▶ From the central unit's operating menu, choose "Interpretation", "Configuration" and "Select Booth" one after the other. The current booth number is shown on the display.
- ▶ Choose the number of the booth whose main target language (A-channel) you want to configure and press the ENTER key.
- ▶ Choose "Language" and press the ENTER key. The current main target language is shown on the display.
- ▶ Choose the desired main target language and press the ENTER key to save your setting. The configuration of the main target language of a booth **cannot** be changed on the interpreter consoles!

```
Booth Configuration
1   Language
```

Example:

Let us assume that the active languages at a conference are English, German and French. You then have to configure e.g. an "English" booth by choosing "English" as the main target language for this booth.

Configuring the second target language (B-channel) of a booth

An interpreter may work into several target languages. In order that the interpreter is able to interpret into a second language, the B-channel has to be configured to this language.

Note!

The second target language must already be configured as the main target language of another booth!

The B-channel can be configured either via the interpreter console – even during a conference – (see "Configuring the B-channel of an interpreter console" on page 38) or via the central unit's operating menu:

- ▶ From the central unit's operating menu, choose "Interpretation", "Configuration" and "Select booth" one after the other. The current booth number is shown on the display.
- ▶ Choose the number of the booth whose second target language (B-channel) you want to configure and press the ENTER key.
- ▶ Choose "B-Channel" and press the ENTER key. A booth number is shown on the display.
- ▶ Choose the number of the booth whose main target language corresponds to the language you want to configure for the B-channel.

```
Booth Configuration
2   B-Channel
```

Example:

Let us assume that there are three interpreter booth:

- Booth 1 for the target language **English**
- Booth 2 for the target language **French**
- Booth 3 for the target language **German**

In order to set the B-channel of booth 3 to English, choose "1" from the "B-channel" menu.

Enabling the auto-relay interpretation function (Auto-floor)

If the original floor language is a language of which all interpreters have a complete understanding and from which they work, you **do not** have to enable this function. In this case, all interpreters interpret the original floor language into their respective target languages. These interpretations are then fed to the corresponding interpretation channels.

If the original floor language is **not** a language of which all interpreters have a complete understanding and from which they work, you can enable the auto-relay interpretation function (auto-floor): The original floor language is interpreted into a language understood by all interpreters. This interpretation is automatically “relayed” to the floor channel of all other interpreters and serves as the basis from which they interpret into their respective target languages.

To enable the auto-relay interpretation function (auto-floor):

Caution!

The interpreter who delivers the relay interpretation has to choose the **B-channel!**

- ▶ From the central unit’s operating menu, choose “Interpretation”, “Configuration” and “Select Booth” one after the other. The current booth number is shown on the display.
- ▶ Choose the number of the booth from which the relay interpretation is to be delivered and press the ENTER key.
- ▶ Choose “Auto-floor” and press the ENTER key.
- ▶ Choose “Yes” to enable the auto-floor function and press the ENTER key to save this configuration. The relay interpretation is automatically “relayed” to the floor channel of all other interpreter consoles and the AUTOFLOOR LED  on these interpreter consoles lights up, indicating that the auto-floor function is enabled.

```
Booth Configuration
3   Auto-floor
```

```
Booth Configuration
Auto-floor = Yes
Press ENTER to Save
```

Half-automatically initializing all interpreter consoles on the central unit

Once you have configured the number of interpreter booth (see “Setting the max. number of interpreter booths/languages” on page 98) and the number of interpreter consoles per booth (see “Setting the max. number of interpreter consoles per booth” on page 98), you have to initialize all interpreter consoles on the central unit as follows:

- ▶ From the central unit’s operating menu, choose “Interpretation”, “Initialise Units” and “Full Init.” one after the other.

```
Initialise Units
1   Full Init
```

```
Press Mic to confirm
      BOOTH   DESK
      01     01
```

The red signal light rings on all interpreter consoles start flashing and the displays of the interpreter consoles show “01” for both the booth and the desk number.

1. If all of the interpreter consoles which were configured via the central unit are connected, you can half-automatically initialize the interpreter consoles, i.e. by pressing the MIC key  of an interpreter

console, this console is initialized on the central unit with the booth and desk number shown on the console's display.

- ▶ Start initializing the interpreter consoles by pressing the MIC key 15 of interpreter console 1 in booth 1. The red signal light ring of the interpreter console stops flashing. The booth and desk numbers of all subsequent interpreter consoles are automatically increased according to the preset number of booths and the preset number of interpreter consoles per booth.
- ▶ Continue by pressing the MIC key 15 of interpreter console 2 in booth 1, and so on.
- ▶ If all booth and desk numbers are assigned correctly, press the ENTER key on the central unit to save this configuration.

```
Full Init
Press ENTER to save
```

```
01 ENG
02 ARA
00 00 00 00
FLO FLO FLO FLO
```

The displays of the interpreter consoles show the languages assigned to the A-channel and the B-channel and other related information (see example illustration on the left).

The interpreter consoles are now ready for operation.

2. Alternatively, you can assign the booth and desk number of an interpreter console individually (see "Manually assigning an interpreter console an individual booth number" on page 102 and "Manually assigning an interpreter console an individual desk number (interpreter console number)" on page 103).

Manually assigning an interpreter console an individual booth number

To manually assign an interpreter console an individual booth number (BOOTH):

- ▶ From the central unit's operating menu, choose "Interpretation", "Initialise Units" and "Full Init" one after the other.
- ▶ Press the RELAY 1 key 17 of the desired interpreter console and keep it pressed.
- ▶ While keeping the RELAY 1 key pressed, press the "MENU ▲" or "MENU ▼" menu selection key 20 until the desired booth number (BOOTH) is shown on the display.

```
Initialise Units
1 Full Init
```

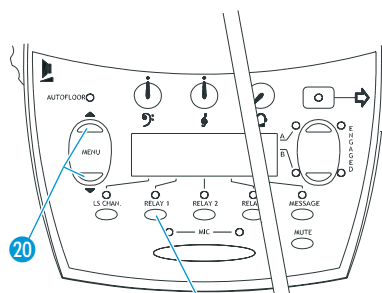

```
Press Mic to confirm
BOOTH 02
DESK 01
```

- ▶ Press the MIC key 15 to transmit the selected booth number to the central unit.

Note!

If an error occurs during initialization, the text "Init. Refused" is shown on the displays of the interpreter consoles. In this case, reinitialize the interpreter consoles.

```
Full Init
Press ENTER to save
```

```
01 ENG
02 ARA
00 00 00 00
FLO FLO FLO FLO
```

- ▶ If all booth and desk numbers are assigned correctly, press the ENTER key on the central unit to save this configuration.

The displays of the interpreter consoles show the languages assigned to the A-channel and the B-channel and other related information (see example illustration on the left).

The interpreter consoles are now ready for operation.

Note!

The max. number of interpreter consoles per booth has to be configured via the central unit (see "Setting the max. number of interpreter consoles per booth" on page 98 and "Half-automatically initializing all interpreter consoles on the central unit" on page 101).

Manually assigning an interpreter console an individual desk number (interpreter console number)

To manually assign an interpreter console an individual desk number (DESK):

```
Initialise Units
1 Full Init
```

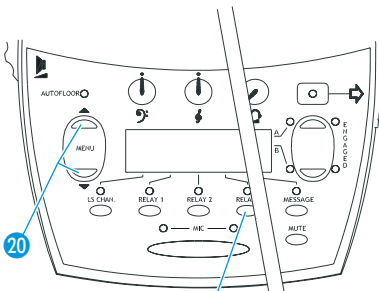

- ▶ From the central unit's operating menu, choose "Interpretation", "Initialise Units" and "Full Init" one after the other.

- ▶ Press the RELAY 3 key 17 of the desired interpreter console and keep it pressed.

- ▶ While keeping the RELAY 3 key pressed, press the "MENU ▲" or "MENU ▼" menu selection key 20 until the desired desk number (DESK) is shown on the display.

```
Press Mic to confirm
BOOTH    DESK
01       02
```

- ▶ Press the MIC key 15 to transmit the selected desk number to the central unit.

Note!

If an error occurs during initialization, the text "Init Refused" is shown on the displays of the interpreter consoles. In this case, reinitialize the interpreter consoles.

```
Full Init
Press ENTER to save
```

```
01 ENG
02 ARA
00 00 00 00
FLO FLO FLO FLO
```

- ▶ If all booth and desk numbers are assigned correctly, press the ENTER key on the central unit to save this configuration.

The displays of the interpreter consoles show the languages assigned to the A-channel and the B-channel and other related information (see example illustration on the left).

The interpreter consoles are now ready for operation.

Note!

The max. number of interpreter consoles per booth has to be configured via the central unit (see "Setting the max. number of interpreter consoles per booth" on page 98 and "Half-automatically initializing all interpreter consoles on the central unit" on page 101).

Displaying the booth and desk number of an interpreter console

To display the booth and desk number of an interpreter console:

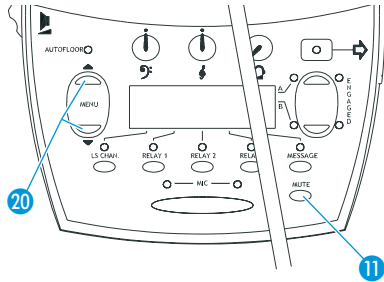

- ▶ Press the MUTE key 11 and keep it pressed.
- ▶ While keeping the MUTE key pressed, press the "MENU ▲" or "MENU ▼" menu selection key 20. The booth and desk number of this interpreter console appear on the display.

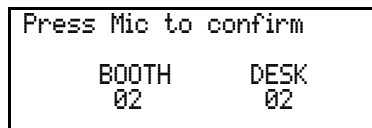

Adding interpreter consoles to an existing configuration

To add individual interpreter consoles to an already existing configuration:

- ▶ From the central unit's operating menu, choose "Interpretation", "Initialise Units" and "Add Unit" one after the other. The red signal light rings on all interpreter consoles which have not yet been assigned a booth and desk number start flashing and the interpreter consoles' displays show "01" for both the booth and the desk number.
- ▶ On all interpreter consoles not yet initialized, manually assign the booth number (see "Manually assigning an interpreter console an individual booth number" on page 102) and the desk number (see "Manually assigning an interpreter console an individual desk number (interpreter console number)" on page 103)
- ▶ If all booth and desk numbers are assigned correctly, press the ENTER key on the central unit to save this configuration. The displays of the interpreter consoles show the languages assigned to the A-channel and the B-channel and other related information (see example illustration on the left).

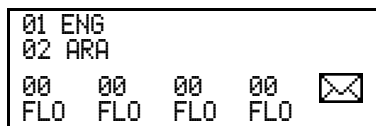

The interpreter consoles are now ready for operation.

Loading the factory-preset default configuration for the interpretation system

If necessary, you can load the factory-preset default configuration for the interpretation system.

Caution!

Loading the factory-preset default configuration will delete all setting of your current configuration! Your interpretation system then has to be re-configured to become operational!

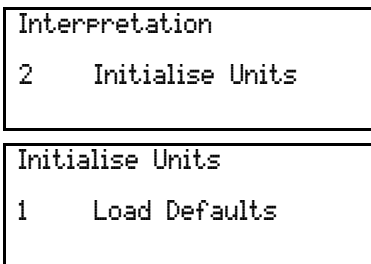

To load the factory-preset default configuration for the interpretation system:

- ▶ From the central unit's operating menu, choose "Interpretation", "Initialise Units" and "Load Defaults" one after the other. The text "Configuration will be overwritten. Continue?" is shown on the display.
- ▶ Press the ENTER key to replace your current configuration by the factory-preset default configuration.

Resetting the interpretation system

You should reset the interpretation system each time you have made changes to the configuration of the interpretation system via the central unit. Resetting the interpretation system has no effect on the conference system, i.e. you can make changes to the configuration of your interpretation system even during a conference.

To reset the interpretation system:

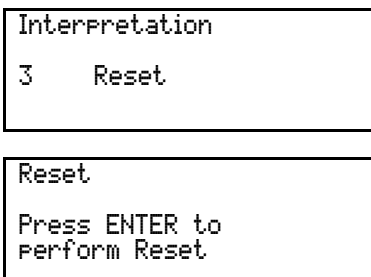

- ▶ From the central unit's operating menu, choose "Interpretation" and "Reset" one after the other.
- ▶ Press the ENTER key. The interpretation system is reset and the saved configuration becomes effective.

Configuring the audio inputs and outputs

You can connect external audio sources such as a CD player, a microphone with preamplifier etc. to the central unit's audio inputs. Instead of connecting an external audio source, you can connect the audio output of a conference system installed in a separate room to carry out a remote conference. Via the audio outputs, you can connect e.g. a recording unit.

Via the "Aux-In/Out" menu, you can configure the central unit's audio inputs and outputs for the connected equipment.

Choosing the audio inputs and outputs

The central unit features six audio outputs.

The output signal of the floor channel is always available at the output AUX OUT 1. The output AUX OUT 1 is available at the XLR-3M socket 10 and the 15-pole sub-D socket 15 (for the pin assignment of this socket, please refer to page 57).

The outputs AUX OUT 2 - 3 - 4 - 5 - 6 are available at the 15-pole sub-D socket 15 (for the pin assignment of this socket, please refer to page 57).

The two inputs AUX IN 1 and AUX IN 2 are available at the two XLR-3F sockets 8 and 9.

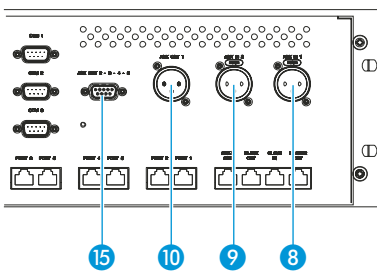

```
Aux-In/Out
1   Aux Out 1
```

To choose the audio output or input to be configured:

- ▶ From the central unit’s operating menu, choose “Aux-In/Out”.
- ▶ Then choose between the following inputs and outputs:
 - Aux Out 1
 - Aux Out 2
 - Aux Out 3
 - Aux Out 4
 - Aux Out 5
 - Aux Out 6
 - Aux In 1
 - Aux In 2
- ▶ Press the ENTER key to activate the menu item.

Adjusting the volume of the audio outputs

Attention! High Volume!

This is a professional conference system. Commercial use is subject to the rules and regulations of the trade association responsible. Sennheiser, as the manufacturer, is therefore obliged to expressly point out possible health risks arising from use.

This system is capable of producing sound pressure exceeding 85 dB(A). 85 dB(A) is the sound pressure corresponding to the maximum permissible volume which is by law (in some countries) allowed to affect your hearing for the duration of a working day. It is used as a basis according to the specifications of industrial medicine. Higher volumes or longer durations can damage your hearing. At higher volumes, the duration must be shortened in order to prevent damage. The following are sure signs that you have been subjected to excessive noise for too long a time:

- You can hear ringing or whistling sounds in your ears.
- You have the impression (even for a short time only) that you can no longer hear high notes.

To set the volume of the output signal available at one of the audio outputs:

- ▶ From the central unit’s operating menu, choose “Aux-In/Out”.
- ▶ Choose the desired audio output.
- ▶ Choose “Volume”.
The current volume is shown on the display.
- ▶ Adjust the volume and press the ENTER key to save your setting.

```
Aux Out 3
1   Volume
```

```
Aux Out 3
Volume = 00
Press ENTER to Save
```

Adjusting the volume differences between the Aux Out 1 outputs

The volume of the AUX OUT 1 output available at the XLR-3M socket ⑩ differs from the volume of the AUX OUT 1 output available at the 15-pole sub-D socket ⑮. If you switch between the two outputs during a conference, the volume can vary.

Attention! High Volume!

This is a professional conference system. Commercial use is subject to the rules and regulations of the trade association responsible. Sennheiser, as the manufacturer, is therefore obliged to expressly point out possible health risks arising from use.

This system is capable of producing sound pressure exceeding 85 dB(A). 85 dB(A) is the sound pressure corresponding to the maximum permissible volume which is by law (in some countries) allowed to affect your hearing for the duration of a working day. It is used as a basis according to the specifications of industrial medicine. Higher volumes or longer durations can damage your hearing. At higher volumes, the duration must be shortened in order to prevent damage. The following are sure signs that you have been subjected to excessive noise for too long a time:

- You can hear ringing or whistling sounds in your ears.
- You have the impression (even for a short time only) that you can no longer hear high notes.

To adjust the volume difference between the XLR-3M socket and the 15-pole sub-D socket:

```
Aux Out 1
2   Volume XLR

Aux Out 1
Volume XLR = 24
Press ENTER to Save
```

- ▶ From the central unit's operating menu, choose "Aux-In/Out" and "Aux Out 1" one after the other.
- ▶ Choose "Volume XLR".
The current volume is shown on the display.
- ▶ Reduce the volume and press the ENTER key to save your setting.

Assigning a channel to an audio output

Each of the audio outputs AUX OUT 2, AUX OUT 3, AUX OUT 4, AUX OUT 5 and AUX OUT 6 can be assigned a channel. The maximum number of channels available depends on your license. The configuration of four channels/languages is license-free. In order to be able to configure more than four channels/languages (SDC 8200 CU only), you have to purchase one of the language licenses available.

Note!

The floor channel is always assigned to the audio output AUX OUT 1. This assignment cannot be changed!

To assign a channel:

- ▶ From the central unit's operating menu, choose "Aux-In/Out".
- ▶ Choose one of the audio outputs AUX OUT 2 to AUX OUT 6.

```
Aux Out 3
2 Channel
```

```
Aux Out 3
Channel = 00
Press ENTER to Save
```

- ▶ Choose "Channel".
The current channel number is shown on the display.
- ▶ Choose the desired channel number and press the ENTER key to save your setting.
The desired channel is available at the selected audio output.

Turning on/off the audio inputs or outputs

To turn the audio outputs or inputs on and off:

```
Aux Out 3
3 Status
```

```
Aux Out 3
Status = OFF
Press ENTER to Save
```

- ▶ From the central unit's operating menu, choose "Aux-In/Out".
- ▶ Choose the desired audio output or input.
- ▶ Choose "Status".
The current status ("ON" or "OFF") of the audio output or input is shown on the display.
- ▶ Change the status and press the ENTER key to save your setting.
The selected audio output or input is turned on or off.

Adjusting the volume differences between the headphone outputs

You can connect headphones either to the headphone output on the front panel of the central unit or to the Aux Out 6 output on the rear panel of the central unit. Please note that there is a volume difference between the two headphone outputs, so if you switch between the two outputs during a conference, the volume can vary.

Attention! High Volume!

This is a professional conference system. Commercial use is subject to the rules and regulations of the trade association responsible. Sennheiser, as the manufacturer, is therefore obliged to expressly point out possible health risks arising from use.

This system is capable of producing sound pressure exceeding 85 dB(A). 85 dB(A) is the sound pressure corresponding to the maximum permissible volume which is by law (in some countries) allowed to affect your hearing for the duration of a working day. It is used as a basis according to the specifications of industrial medicine. Higher volumes or longer durations can damage your hearing. At higher volumes, the duration must be shortened in order to prevent damage. The following are sure signs that you have been subjected to excessive noise for too long a time:

- You can hear ringing or whistling sounds in your ears.
- You have the impression (even for a short time only) that you can no longer hear high notes.

```
Aux Out 6
2   Volume HeadPhone
```

```
Aux Out 6
Volume HeadPhone = 18
Press ENTER to Save
```

```
Aux Out 1
3   Remote Conf.
```

```
Aux Out 1
Remote Conf. = OFF
Press ENTER to Save
```

```
Aux-In/Out
9   External Equalizer
```

```
External Equalizer
Status = OFF
Press ENTER to Save
```

To adjust the volume difference between the headphone outputs:

- ▶ From the central unit's operating menu, choose "Aux-In/Out" and "Aux Out 6" one after the other.
- ▶ Choose "Volume HeadPhone".
The current volume is shown on the display.
- ▶ Reduce the volume and press the ENTER key to save your setting.

Configuring the audio outputs for remote conferencing

To prevent echo during remote conferencing:

- ▶ Make sure that the two central units of the conference systems installed in separate rooms are connected correctly (see "Setting up remote conferences" on page 57).
- ▶ From the central unit's operating menu, choose "Aux-In/Out".
- ▶ Choose the audio output "Aux Out 1".
- ▶ Choose "Remote Conf.".
The current setting ("Remote Conf. = ON" or "Remote Conf. = OFF") is shown on the display.
- ▶ To prevent echo, choose "Remote Conf. = ON" (if not yet chosen) and press the ENTER key to save your setting.

Turning on/off an external equalizer

If you connect an external equalizer to the central unit, you have to activate the equalizer via the central unit's operating menu.

- ▶ From the central unit's operating menu, choose "Aux-In/Out" and "External Equalizer" one after the other.
- ▶ Choose "Status".
The current status ("ON" or "OFF") is shown on the display.
- ▶ Choose "Status = ON" and press the ENTER key to save your setting.

Note!

If the external equalizer is activated via the central unit's operating menu, the central unit outputs the audio signals of the consoles' microphones via the audio output and not via the consoles' built-in loudspeakers. However, if no external equalizer is connected, no audio signals can be heard through the consoles' built-in loudspeakers.

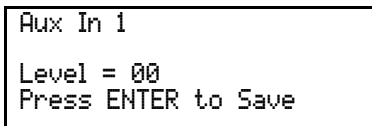
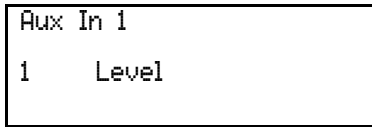

Adjusting the input level of an audio input

To adjust the input level of the two audio inputs:

- ▶ From the central unit's operating menu, choose "Aux-In/Out".
- ▶ Choose the desired audio input.
- ▶ Choose "Level".
The current input level is shown on the display.
- ▶ Adjust the input level and press the ENTER key to save your setting.

Adjusting the input sensitivity of an audio input

Depending on the strength of the audio signal delivered by the external audio source, adapt the input sensitivity as follows:

- ▶ From the central unit's operating menu, choose "Aux-In/Out".
- ▶ Choose the desired audio input.
- ▶ Choose "Sensitivity".
The current input sensitivity ("LOW" or "HIGH") is shown on the display.
 - Choose "LOW" if the connected audio source delivers a strong signal (e.g. CD player).
 - Choose "HIGH" if the connected audio source delivers a weak signal (e.g. microphone).
- ▶ Adjust the input sensitivity and press the ENTER key to save your setting.

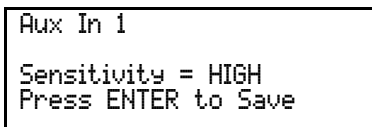
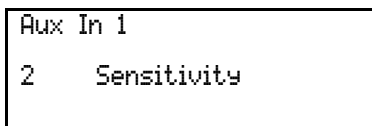

Configuring the outputs of the SDC 8200 analog output unit

You can configure the outputs of the SDC 8200 AO analog output unit via the two DIP switches and the rotary switch located on the printed circuit board of the SDC 8200 AO. For configuring the outputs, you have to open the analog output unit.

The two DIP switches and the rotary switch are located in the middle of the printed circuit board, directly behind the front panel.

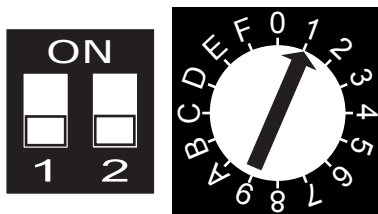

Caution!

Disconnect the SDC 8200 AO from the central unit before configuring the SDC 8200 AO's outputs!

With the two DIP switches (2 switch positions: ON or OFF) and the rotary switch (16 switch positions: 1 to F), you assign a channel number to the output OUT 1 (reference output). The outputs OUT 2 to OUT 8 are automatically assigned the subsequent channel numbers.

The following table shows the possible switch positions and the resulting channel assignments:

DIP switches		Rotary switch	OUT 0	OUT 1	OUT 2	OUT 3	OUT 4	OUT 5	OUT 6	OUT 7	OUT 8
2	1										
OFF	OFF	0	0	0	1	2	3	4	5	6	7
OFF	OFF	1	0	1	2	3	4	5	6	7	8
OFF	OFF	2	0	2	3	4	5	6	7	8	9
OFF	OFF	...	0
OFF	OFF	F	0	15	16	17	18	19	20	21	22
(*)	ON	0	0	16	17	18	19	20	21	22	23
(*)	ON	1	0	17	18	19	20	21	22	23	24
(*)	ON	...	0
(*)	ON	4	0	20	21	22	23	24	25	26	27
(*)	ON	5	0	21	22	23	24	25	26	27	28

(*) can be set to position "ON" or "OFF"

The row marked in grey shows the factory-preset standard configuration. The column marked in grey shows the reference output OUT 1 and the channel numbers assigned.

Example:

Your system accommodates 16 interpretation channels and you want to output each interpretation channel via its own audio output. To do so, you require two analog output units whose outputs have to be configured as follows:

- ▶ The factory-preset standard configuration of the first analog output unit remains unchanged (the channels 1 to 8 are output via the unit's outputs OUT 1 to OUT 8, the floor channel is output via output OUT 0).
- ▶ Make sure that the second analog output unit is not connected!
- ▶ Open the second analog output unit by removing the seven screws on the top of the housing as well as the screw on the front panel with a 2.0 mm Allan key and lift the cover off the unit.
- ▶ Leave the two DIP switches in position "OFF" as shown in the illustration on the left.
- ▶ Use a screwdriver to set the rotary switch to position "9".
- ▶ Close the housing and tighten the screws. In order to avoid that the two analog output units are later confused, we recommend marking the second analog output unit with a sticker.
- ▶ Connect the second analog output unit as described in the section "Connecting several SDC 8200 AO analog output units to the SDC 8200 CU central unit" on page 58. The channels 9 to 16 are output via the outputs OUT 1 to OUT 8 of the analog output unit. The floor channel is output via the unit's output OUT 0.

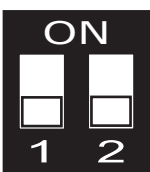

Making a system diagnosis

Displaying the number of consoles connected to the central unit

To display the number of consoles connected to the central unit:

```
Diaenostics
1   Port Status
```

```
Port Status
15 15 14 02 15 15
P1 P2 P3 P4 P5 P6
```

- ▶ From the central unit's operating menu, choose "System", "Diaenostics" and "Port Status" one after the other. The ports „P1“ to „P6“ with their respective number of connected consoles are shown on the display.

```
Diaenostics
1   Port Errors
```

```
Port Errors
☐ ☐ ☐ [!] ☐ ✕
P1 P2 P3 P4 P5 P6
```

Checking the communication within a cable string

To display if and on which port(s) a communications error has occurred:

- ▶ From the central unit's operating menu, choose "System", "Diaenostics" and "Port Errors" one after the other. The ports „P1“ to „P6“ with a respective symbol are shown on the display. The symbols have the following meanings:

☐: A cable string with consoles is connected to the port.

✕: No cable string is connected to the port. If this symbol appears even though a cable string is connected to the port, check if the cable string is connected correctly.

[!]: A communications error has occurred. This symbol only appears if a cable string is connected to the port.

Configuring connected additional components

Turning on/off a camera control

If you connect an external camera control to the central unit, you have to activate the camera control via the central unit's operating menu.

To turn a connected camera control on:

```
System
2   Camera Control
```

```
Camera Control
Status = OFF
Press ENTER to Save
```

- ▶ From the central unit's operating menu, choose "System" and "Camera Control" one after the other. The current status of the camera control is shown on the display.
- ▶ Choose "Status = ON" and press the ENTER key to save your setting.

Turning on a connected control panel

instead of controlling the SDC 8200 conference and interpretations system via a PC with software control, you can use a control panel (optional). The control panel is a miniature physical representation of your conference room, allowing you to turn on or off individual conference consoles, change the volume, change the conference mode, display the status of the interpreter booths, etc.

The control panel will be custom tailored to your specific requirements.

To turn a connected control panel on:

- ▶ From the central unit's operating menu, choose "System" and "Control Panel" one after the other.
The current status of the control panel is shown on the display.
- ▶ Choose "Status = ON" and press the ENTER key to save your setting.

```
System
3   Control Panel
```

```
Control Panel
Status = OFF
Press ENTER to Save
```

```
System
4   Ambient Sound
```

Configuring an "ambient sound" console

Optionally, you can use an "ambient sound" console with your SDC 8200 conference and interpretation system. As soon as all other consoles in the conference room are deactivated, the "ambient sound" console automatically turns on in order to reproduce the ambient noise within the conference room. The "ambient sound" console enables the interpreters, who often cannot look into the conference room, to hear what is going on in the conference room, so that they are prepared if a speaker takes the floor again.

Note!

You require a special "ambient sound" console and a separate microphone! For details on how to connect these components to the central unit, please refer to the operating manual of the "ambient sound" console.

To turn a connected "ambient sound" console on:

- ▶ From the central unit's operating menu, choose "System", "Ambient Sound" and "Status" one after the other.
- ▶ Choose "Status = ON" and press the ENTER key to turn the "ambient sound" console on.

```
Ambient Sound
1   Status
```

```
Status
Status = ON
Press ENTER to Save
```

```
Ambient Sound
2 Loudspeaker
```

```
Loudspeaker
Switch Off = No
Press ENTER to Save
```

```
Ambient Sound
3 Aux Out
```

```
Aux Out
Switch Off = Yes
Press ENTER to Save
```

```
Ambient Sound
4 Aux In
```

```
Aux In
Switch Off = No
Press ENTER to Save
```

```
System
5 Version
```

```
Version
xx-xx-xx x.xx
```

To turn the built-in loudspeaker of the “ambient sound” console on or off:

- ▶ From the central unit’s operating menu, choose “System”, “Ambient Sound” and “Loudspeaker” one after the other.
- ▶ To turn the loudspeaker on, choose “Switch Off = No”; to turn the loudspeaker off, choose “Switch Off = Yes”.
- ▶ Press the ENTER key to save your setting.

To turn the AUX output signal of the “ambient sound” console on or off:

- ▶ From the central unit’s operating menu, choose “System”, “Ambient Sound” and “Aux Out” one after the other.
- ▶ To turn the AUX output signal on, choose “Switch Off = No”; to turn the AUX output signal off, choose “Switch Off = Yes”.
- ▶ Press the ENTER key to save your setting.

To turn the AUX input signal of the “ambient sound” console on or off:

- ▶ From the central unit’s operating menu, choose “System”, “Ambient Sound” and “Aux In” one after the other.
- ▶ To turn the AUX input signal on, choose “Switch Off = No”; to turn the AUX input signal off, choose “Switch Off = Yes”.
- ▶ Press the ENTER key to save your setting.

Software, language and license

Displaying the version number of the central unit’s software

To display the version number of the central unit’s software:

- ▶ From the central unit’s operating menu, choose “System” and “Version” one after the other.
- The current version number of the central unit’s software is shown on the display.

Choosing the language of the central unit’s operating menu

You can choose between the following six menu languages:

- English
- French
- Dutch
- German
- Spanish
- Italian

```

Language
1   Choose Language

```

```

Choose Language
English

```

```

License
1   Serial Number

```

```

Serial Number
xxxxxxx

```

```

License
2   View License

```

```

View License
xxxx-xxxx-xxxx-xxxx

```

```

License
3   Upgrade License

```

```

Upgrade License
0

```

To choose the language:

- ▶ From the central unit's operating menu, choose "Language" and "Choose Language" one after the other.
- ▶ Choose the desired language and press the ENTER key.

Displaying the central unit's serial number

To display the central unit's serial number:

- ▶ From the central unit's operating menu, choose "License" and "Serial Number" one after the other.
- The serial number is shown on the display.

Displaying the license code of your conference and interpretation system

To display the license code of your conference and interpretation system:

- ▶ From the central unit's operating menu, choose "License" and "View License" one after the other.
- The current license code is shown on the display.

Upgrading the license of your conference and interpretation system

The SDC 8200 CU and SDC 8200 CU-M central units come with a basic license, allowing the configuration of four languages/interpretation channels as well as the "camera control" function.

Please note that only the SDC 8200 CU central unit can be expanded by purchasing licenses for further languages/interpretation channels. These licenses (see "Licenses for expanding the SDC 8200 CU central unit" on page 117) are available from Sennheiser electronic.

To enter a new license code:

- ▶ From the central unit's operating menu, choose "License" and "Upgrade License" one after the other.
- "0" is shown on the display.
- ▶ Turn the jog wheel **4** on the central unit until the first character of the new license code is shown on the display and then press the ENTER key.
 - ▶ In the same way, enter all other characters of the new license code one after the other until the new license code is entered completely.

If you entered a wrong character:

- ▶ Press the EXIT key to exit this menu item. "Upgrade License" is shown on the display.
- ▶ Press the ENTER key. "0" is shown on the display.
- ▶ Re-start entering the new license code.

If problems occur...

Replacing a fuse

If the fuse of a central unit has blown, the subsequent consoles cannot be powered.

To replace the fuse:

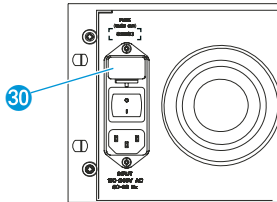

- ▶ Use a screwdriver to carefully loosen the fuse holder 30 and pull it out completely.
- ▶ Remove the faulty fuse.
- ▶ Insert a new fuse (5 x 20 mm, 3.15 AT).

Conference/interpreter console does not work

- ▶ Make sure that the system cables between the central unit and the conference/interpreter console are not defective and that the system cables are connected correctly.
- ▶ Make sure that the central unit is connected to the mains and that it is turned on.

Only the microphone of the chairman unit can be activated

- ▶ Make sure that the max. number of simultaneously active microphones is set to at least "1" (see "Setting the speaker limit" on page 90).

No audio signal can be heard through the consoles' built-in loudspeakers

If no external equalizer is connected:

- ▶ Make sure that in the central unit's operating menu, the status of the external equalizer is set to "OFF" (see "Turning on/off an external equalizer" on page 109).

If an external equalizer is connected:

- ▶ Make sure that the external equalizer is connected correctly.
- ▶ Make sure that the external equalizer is turned on.
- ▶ Make sure that in the central unit's operating menu, the status of the external equalizer is set to "ON" (see "Turning on/off an external equalizer" on page 109).

Maintenance and care

- ▶ Use a damp cloth for cleaning the components of the conference and interpretation system from time to time.
Never use solvents or solvent-containing cleansers, as these could damage the surfaces of the components.

Accessories

System components

500867	SDC 8200 CU	CU central unit
500860	SDC 8200 CU-M	CU-M central unit
500868	SDC 8200 AO	Analog output unit with nine outputs
on request		Control panel according to customer specifications
500863	SDC 8200 D	Delegate unit
500858	SDC 8200 C	Chairman unit
500864	SDC 8200 DC	Delegate unit with channel selection keys
500859	SDC 8200 CC	Chairman unit with channel selection keys
500865	SDC 8200 DV	Delegate unit with voting function
500862	SDC 8200 CV	Chairman unit with voting function
009849	SDC 8000 CARD	Chip card
500866	SDC 8200 ID	Interpreter console

Software for PC controlling the SDC 8200 CU central unit

500975	SDC 8200 SYS	
502053	SDC 8200 SYS	CD-ROM update
500976	SDC 8200 S-MM	Software module "Mic Management"
500978	SDC 8200 S-VM	Software module "Voting Management"
500979	SDC 8200 S-VD	Software module "Result Display"
500980	SDC 82008200 S-IM	Software module "Interpreter Management"
500977	SDC 8200 S-DM	Software module "Delegate Management"

Software for PC controlling the SDC 8200 CU-M central unit

500969	SDC 8200 SYS-M	
--------	----------------	--

System cables

009842	SDC CBL RJ45-2	System cable with two shielded RJ 45 plugs, 2 m
009853	SDC CBL RJ45-3	System cable with two shielded RJ 45 plugs, 3 m
009844	SDC CBL RJ45-5	System cable with two shielded RJ 45 plugs, 5 m
009845	SDC CBL RJ45-10	System cable with two shielded RJ 45 plugs, 10 m
009846	SDC CBL RJ45-20	System cable with two shielded RJ 45 plugs, 20 m
009847	SDC CBL RJ45-50	System cable with two shielded RJ 45 plugs, 50 m

Licenses for expanding the SDC 8200 CU central unit

500981	SDC 8200 LL-8	License for 8 language channels
500982	SDC 8200 LL-28	License for 28 language channels

Specifications

Features of the central units

Features	SDC 8200 CU	SDC 8200 CU-M
Max. number of consoles	120	50
Operation of the SDC 8200 DV delegate unit	yes	no
max. number of connectable Analog output units	4	–
Daisy-chainable	yes	no
expandable by additional licenses	yes	no
Voting modes	1 of 3 1 of 5	1 of 3
Channels	4, 8 or 28	4
Interpreters per booth	8	2

Consoles

SDC 8200 D

Frequency response	100 – 14,000 Hz
Pick-up pattern	cardioid
Headphone output	3.5 mm mono jack socket ($\geq 16 \Omega$)
Maximum output level at headphone output	1.5 V at 32 Ω
S/N at headphone output	> 75 dBA
Power consumption	max. 2.5 W
Operating temperature	0 to +50 °C
Standards	IEC 849
Housing	recyclable ABS
Dimensions	approx. W 150 mm, H 80 mm, D 185 mm
Microphone gooseneck length	approx. 380 mm
Weight	approx. 570 g

SDC 8200 C

Frequency response	100 – 14,000 Hz
Pick-up pattern	cardioid
Headphone output	3.5 mm mono jack socket ($\geq 16 \Omega$)
Maximum output level at headphone output	1.5 V at 32 Ω
S/N at headphone output	> 75 dBA
Power consumption	max. 2.5W
Operating temperature	0 to +50 °C
Standards	IEC 849
Housing	recyclable ABS
Dimensions	approx. W 150 mm, H 80 mm, D 185 mm
Microphone gooseneck length	approx. 380 mm
Weight	approx. 570 g

SDC 8200 DC

Frequency response	100 – 14,000 Hz
Pick-up pattern	cardioid
Headphone output	3.5 mm mono jack socket ($\geq 16 \Omega$)
Maximum output level at headphone output	1.5 V at 32 Ω
S/N at headphone output	> 75 dBA
Power consumption	max. 2.5 W
Operating temperature	0 to +50 °C
Standards	IEC 849
Housing	recyclable ABS
Dimensions	approx. W 150 mm, H 80 mm, D 185 mm
Microphone gooseneck length	approx. 380 mm
Weight	approx. 570 g

SDC 8200 CC

Frequency response	100 – 14,000 Hz
Pick-up pattern	cardioid
Headphone output	3.5 mm mono jack socket ($\geq 16 \Omega$)
Maximum output level at headphone output	1.5 V at 32Ω
S/N at headphone output	> 75 dBA
Power consumption	max. 2.5 W
Operating temperature	0 to +50 °C
Standards	IEC 849
Housing	recyclable ABS
Dimensions	approx. W 150 mm, H 80 mm, D 185 mm
Microphone gooseneck length	approx. 380 mm
Weight	approx. 570 g

SDC 8200 DV

Frequency response	100 – 14,000 Hz
Pick-up pattern	cardioid
Headphone output	3.5 mm mono jack socket ($\geq 16 \Omega$)
Maximum output level at headphone output	1.5 V at 32Ω
S/N at headphone output	> 75 dBA
Power consumption	max. 3.5 W
Operating temperature	0 to +50 °C
Standards	IEC 849
Housing	recyclable ABS
Dimensions	approx. W 150 mm, H 80 mm, D 185 mm
Microphone gooseneck length	approx. 380 mm
Weight	approx. 590 g

SDC 8200 CV

Frequency response	100 – 14,000 Hz
Pick-up pattern	cardioid
Headphone output	3.5 mm mono jack socket ($\geq 16 \Omega$)
Maximum output level at headphone output	1.5 V at 32 Ω
S/N at headphone output	> 75 dBA
Power consumption	max. 3.5 W
Operating temperature	0 to +50 °C
Standards	IEC 849
Housing	recyclable ABS
Dimensions	approx. W 150 mm, H 80 mm, D 185 mm
Microphone gooseneck length	approx. 380 mm
Weight	approx. 590 g

SDC 8200 ID

Frequency response	100 – 14,000 Hz
Pick-up pattern	cardioid
Headphone output	3.5 mm mono jack socket ($\geq 16 \Omega$)
Headset output	3.5 mm stereo jack socket ($\geq 16 \Omega$)
Maximum output level at headphone output	1.5 V at 32 Ω
S/N at headphone output	> 75 dBA
Power consumption	max. 3.5 W
Operating temperature	0 to +50 °C
Standards	IEC 849
Housing	recyclable ABS
Dimensions	approx. W 150 mm, H 80 mm, D 185 mm
Microphone gooseneck length	approx. 380 mm
Weight	approx. 600 g

SDC 8200 CU central unit

AUX IN 1,2	XLR-3F, transformer balanced
Input level	max. +14 dBu
Input impedance	> 6 k Ω at 1 kHz
Frequency response	100 – 14,000 Hz
AUX OUT 1	XLR-3M, transformer balanced
Output level	max. +6 dBu
Output impedance	< 200 Ω at 1 kHz
S/N	max. 78 dBA
Frequency response	100 – 14,000 Hz
THD+N	\leq 0.05 % (0 dBu)
AUX OUT 2, 3, 4, 5, 6	15-pole sub-D, unbalanced
Output level	max. +0 dBu
Output impedance	< 100 Ω at 1 kHz
S/N	max 75 dBA
Frequency response	100 – 14,000 Hz
THD+N	< 0.5 % (0 dBu)
Headphone output	
Output level	max. 750 mV at 32 Ω
S/N	max. 75 dBA
Frequency response	100 – 14,000 Hz
THD+N	< 0.5 % (0 dBu)
PC interface COM 1	RS 232 SUB-D-9 for interpreter software
PC interface COM 2	RS 232 SUB-D-9
PC interface COM 3	RS 232 SUB-D-9 for conference software
Test tone	400 Hz / 1 kHz
Mains voltage	100 – 240 V \pm 10 % (50 – 60 Hz)
Mains current	max. 3.5 A / 230 V; 7.0 A / 115 V
Power consumption	approx. 300 VA
Fuse	3.15 A / 230 V; 7.0 A / 115 V
Output voltage ports 1-6	approx. 48 V
Operating temperature	0 to +50 $^{\circ}$ C
Sound pressure level of fan	48 dBA SPL at 1 m
Dimensions	approx. 485 x 141 x 265 mm
Weight	approx. 6 kg

SDC 8200 AO analog output unit

Power supply	48 V DC supplied via SDC 8200 CU DATA OUT port
Frequency response	100 – 14,000 Hz
Output level (XLR)	max. 0 dBu, balanced
Output level (RCA):	max. 0 dBu, unbalanced
Output Impedance	≤ 80 Ω at 1 kHz
S/N	77 dBA
Operating temperature	0 to +50 °C
Dimensions	483 (19") x 43.2 x 178 mm
Weight	3 kg

RJ 45 cable

Length:	2 m, 3 m, 5 m, 10 m, 50 m
Wire cross section:	24 AWG

Caution!

Do not use any standard Ethernet cable (26 AWG)!

Appendix A: Camera control protocol

The SDC 8200 conference and interpretation system supports camera control. The central unit sends a control command to the connected camera control:

- when a delegate or chairman unit is activated,
- when a delegate or chairman unit is deactivated,
- when all active microphones are deactivated one after the other,
- when all active microphones are deactivated simultaneously (priority function),
- every 5 seconds for synchronization.

These commands are evaluated by the camera control which then automatically aims the camera at a speaker and adjusts the focus.

The camera control must be connected to the SDC 8200 CU central unit's COM 2 interface (RS 232 connection). The settings for the communications port for camera control are:

Bits per second: 19,200

Data bits: 8

Parity: None

Stop bits: 1

Flow control: None

The syntax of the commands

All commands sent by the SDC 8200 CU central unit start with a "%" sign. The last character is a character which states the end of the transmission. Just before the end-of-transmission character, there are four characters within the command sent to the camera control which account for the CRC checksum.

STX "%"	data	CRC	ETX
Start of Transmission Character (0x25 = "%")	Data of the command	16 bit sum of the ASCII characters between STX and CRC	End of Transmission Character (0x0D)

The CRC checksum is in uppercase hexadecimal form while all other numbers are in decimal form.

Commands:

General syntax	General meaning	Examples
{X}{1}{P}{000}{CRC(4)}	The first microphone is activated.	%1P00053 The first microphone is activated. The camera control is activated.
{X}{P}{Mic.-No.}(4){CRC(4)}	The chairman unit is activated.	%P00010111 The chairman unit is activated and it has the microphone number '0001'.
{X}{P}{Mic.-No.}(4){CRC(4)}	The chairman unit is deactivated.	%P00010131 The chairman unit '0001' is deactivated.
{X}{M}{Mic.-No.}(4){CRC(4)}	A delegate unit is activated.	%M00030110 A delegate unit is activated and it has the microphone number '0003'.
{X}{M}{Mic.-No.}(4){CRC(4)}	A delegate unit is deactivated.	%M00030130 The delegate unit '0003' is deactivated.
{X}{1}{P}{000}{CRC(4)}	All active microphones are deactivated and the camera control should reset itself to a neutral starting position.	%1P000052 The camera control should reset itself to its starting position.
{X}{S}{Mic.-No.}(4)1+{CRC(4)}	At a time interval of approx. 5 seconds, a synchronization message is sent to the camera control.	%S00030116 Synchronization check while only the delegate unit with the microphone number '0003' is active.
{X}{S}{0}(4){CRC(4)}	The message contains all the numbers of the active microphones or the number 0 to stipulate that there are no microphones active.	%S000200030004029C Synchronization check while the delegate units '0002', '0003' and '0004' are active.
{X}{U}{0000}{CRC(4)}	All active microphones are deactivated simultaneously.	%U00000113 No microphones are active.
		%U00000116 All active microphones are deactivated simultaneously.

Notation of the general syntax:

- All separate entities in a message are represented between curly brackets, e.g. {CRC}
- Literal strings are between quotes, e.g. 'P'
- Logical entities are neither between brackets nor quotes, e.g. Mic.-No. (microphone number)
- A logical entity will also contain a number between brackets. This number states how many characters the entity exists of, e.g.(4)
- If the subtext 1+ is attached to the entity between curly brackets, this means that one or more occurrences of this entity may occur

Appendix B: Control panel protocol

The SDC 8200 conference and interpretation system supports a control panel. The central unit sends a control command to the connected control panel:

- when a delegate or chairman unit is activated,
- when a delegate or chairman unit is deactivated,
- when a microphone goes into request mode,
- when all active microphones are deactivated simultaneously (priority function).

The control panel sends a control command to the central unit:

- when a delegate or chairman unit is to be activated,
- when a delegate or chairman unit is to be deactivated,
- when the control panel is to be reset (Reset).

The control panel must be connected to the central unit's COM 2 interface (RS 232 connection). The settings for the communications port for the control panel are:

Bits per second: 19,200

Data bits: 8

Parity: None

Stop bits: 1

Flow control: None

Commands

All commands sent by the central unit start with a "%" sign. The last character is a character which states the end of the transmission. Just before the end-of-transmission character, there are four characters within the command sent to the camera control which account for the CRC checksum.

STX "%"	data	CRC	ETX
Start of Transmission Character (0x25 = "%")	Data of the command	16 bit sum of the ASCII characters between STX and CRC	End of Transmission Character (0x0D)

The CRC checksum is in uppercase hexadecimal form while all other numbers are in decimal form.

The commands sent by the central unit and received by the control panel:

General syntax	General meaning	Examples
<code>{X}{1}{L}{Mic.-No.}{4}{CRC}{4}</code>	A microphone is activated.	<code>%L0001013E</code> The microphone with the number '0001' is activated.
<code>{X}{1}{I}{Mic.-No.}{4}{CRC}{4}</code>	A microphone is deactivated.	<code>%I10001015E</code> The microphone with the number '0001' is deactivated.
<code>{X}{1}{D}{Mic.-No.}{4}{CRC}{4}</code>	A microphone goes into request.	<code>%D00020137</code> The microphone with the number '0002' goes into request mode.
<code>{X}{E}{00}{CRC}{4}</code>	All microphones should be reset (priority function).	<code>%IE0000D6</code> All microphones are turned off.

The commands sent by the control panel and received by the central unit:

General syntax	General meaning	Examples
<code>{X}{1}{T}{Mic.-No.}{4}{CRC}{4}</code>	Activate a microphone.	<code>%T00020147</code> The microphone with the number '0002' is to be activated.
<code>{X}{1}{U}{CRC}{4}</code>	Restart the control panel and get information about the microphones to reinitialize the control panel.	<code>%I00087</code> The control panel is to be restarted and the correct information about all active microphones and all microphones in request mode is to be received.
<code>{X}{1}{X}{Volume}{2}{X}{Treble response}{2}{X}{Middle response}{2}{X}{Bass response}{2}{CRC}{4}</code>	Change the volume and sound settings of the consoles' built-in loudspeakers.	<code>%1X0606060606060221</code> Volume, treble, middle and bass response are each to be set to the value "06". <code>%1X0006060606021B</code> All microphones are to be muted.
<code>{X}{1}{U}{Conference mode}{2}{CRC}{4}</code>	Change the conference mode.	<code>%1U0400EA</code> The conference mode is to be changed to "FIFO" mode.
<code>{X}{1}{V}{CRC}{4}</code>	Activate the test tone.	
<code>{X}{1}{W}{CRC}{4}</code>	Deactivate the test tone.	

Notation of the general syntax:

- All separate entities in a message are represented between curly brackets, e.g. `{CRC}`
- Literal strings are between quotes, e.g. 'F'
- Logical entities are neither between brackets nor quotes, e.g. Mic.-No. (microphone number)
- A logical entity will also contain a number between brackets. This number states how many characters the entity exists of, e.g. `{4}`
- Volume, treble, middle and bass response are two-digit values from "00" (minimum) to "12" (maximum)
- The two-digit numbers for the conference modes are: "00" (No Request), "01" (With Request), "02" (With Req. No Clear), "03" (Direct Access), "04" (FIFO),

Appendix C: Repeater for the SDC 8200 system

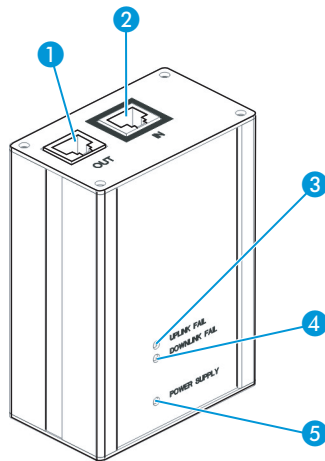
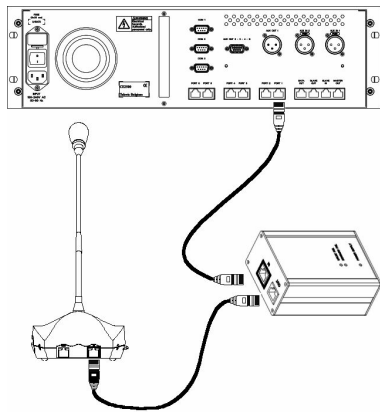

A repeater is used to boost the signal on a system cable. When a system cable reaches a length of 100 m, the signal over the system cables becomes too weak.

You can insert a repeater into the system cable to boost this signal.

The repeater features an IN and an OUT socket. The cable from the central unit should be connected to the IN socket **2** and the following daisy-chain of conference consoles should be connected to the OUT socket **1**.

It is also possible to connect a cable daisy-chain with conference consoles to the central unit and – when the cable daisy-chain reaches 100 m – insert a repeater into the daisy-chain.

The DC power supply which reaches the repeater is 30 to 60 VDC straight from the central unit.

The repeater features three LEDs:

- 3** UPLINK FAIL LED: lights up when there is no communication with a conference console (normally OFF).
- 4** DOWNLINK FAIL LED: lights up when there is no communication from the central unit (normally OFF).
- 5** POWER SUPPLY LED: lights up when power is supplied to the repeater (normally ON).

For purchasing a repeater, please contact your Sennheiser partner.

Manufacturer declarations

Warranty regulations

The guarantee period for this Sennheiser product is 24 months from the date of purchase. Excluded are accessory items, rechargeable or disposable batteries that are delivered with the product; due to their characteristics these products have a shorter service life that is principally dependent on the individual frequency of use.

The guarantee period starts from the date of original purchase. For this reason, we recommend that the sales receipt be retained as proof of purchase. Without this proof (which is checked by the responsible Sennheiser service partner) you will not be reimbursed for any repairs that are carried out.

Depending on our choice, guarantee service comprises, free of charge, the removal of material and manufacturing defects through repair or replacement of either individual parts or the entire device. Inappropriate usage (e.g. operating faults, mechanical damages, incorrect operating voltage), wear and tear, force majeure and defects which were known at the time of purchase are excluded from guarantee claims. The guarantee is void if the product is manipulated by non-authorized persons or repair stations.

In the case of a claim under the terms of this guarantee, send the device, including accessories and sales receipt, to the responsible service partner. To minimise the risk of transport damage, we recommend that the original packaging is used. Your legal rights against the seller, resulting from the contract of sale, are not affected by this guarantee.

The guarantee can be claimed in all countries outside the U.S. provided that no national law limits our terms of guarantee.

CE Declaration of Conformity



This equipment is in compliance with the essential requirements and other relevant provisions of Directives 1999/5/EC, 89/336/EC or 73/23/EC. The declaration is available on the internet site at www.sennheiser.com.

Before putting the equipment into operation, please observe the respective country-specific regulations!

WEEE Declaration



Your Sennheiser product was developed and manufactured with high-quality materials and components which can be recycled and/or reused. This symbol indicates that electrical and electronic equipment must be disposed of separately from normal waste at the end of its operational lifetime.

Please dispose of this product by bringing it to your local collection point or recycling centre for such equipment. This will help to protect the environment in which we all live.



Sennheiser electronic GmbH & Co. KG
30900 Wedemark, Germany
Phone +49 (5130) 600 0
Fax +49 (5130) 600 300
www.sennheiser.com