

 **SENNHEISER**

**evolution**wireless 

**SK 300**



Instruction manual



# Contents

Important safety instructions .....	2
The SK 300 G3 bodypack transmitter .....	3
The frequency bank system .....	3
Areas of application .....	4
Delivery includes.....	5
Product overview.....	6
Overview of the SK 300 bodypack transmitter .....	6
Overview of the displays.....	7
Putting the bodypack transmitter into operation.....	8
Inserting the batteries/accupack .....	8
Charging the accupack.....	8
Connecting the microphone cable/line cable .....	8
Attaching and positioning the microphones .....	9
Attaching the bodypack transmitter to clothing.....	10
Using the bodypack transmitter.....	11
Switching the bodypack transmitter on/off.....	11
Deactivating the lock mode temporarily .....	12
Muting the audio signal or deactivating the RF signal .....	12
Selecting a standard display .....	13
Using the operating menu .....	14
The buttons .....	14
Overview of the operating menu .....	14
Working with the operating menu .....	15
Adjusting settings via the operating menu .....	17
The main menu "Menu" .....	17
The extended menu "Advanced Menu" .....	19
Adjustment tips .....	22
Synchronizing the bodypack transmitter with a receiver.....	22
Cleaning the bodypack transmitter .....	22
If a problem occurs .....	23
Specifications .....	24
Connector assignment.....	25
Polar diagrams and frequency response curves of the microphones .....	25
Manufacturer Declarations.....	26



For more detailed information on the individual sections of this instruction manual, visit the SK 300 G3 product page on our website at [www.sennheiser.com](http://www.sennheiser.com).



There you can also view an animated instruction manual.

## Important safety instructions

- Read this instruction manual.
- Keep this instruction manual. Always include this instruction manual when passing the device on to third parties.
- Heed all warnings and follow all instructions.
- Clean the device only with a slightly damp cloth.
- Do not place the device near any heat sources such as radiators, stoves, or other devices (including amplifiers) that produce heat.
- Only use attachments/accessories specified by Sennheiser.
- When replacement parts are required, only use replacement parts specified by Sennheiser or those having the same characteristics as the original part. Unauthorized substitutions may result in fire, electric shock, or other hazards.
- Refer all servicing to qualified service personnel.  
Servicing is required if the device has been damaged in any way, liquid has been spilled, objects have fallen inside, the device has been exposed to rain or moisture, does not operate properly or has been dropped.
- **WARNING:** To reduce the risk of short circuits, do not use the device near water and do not expose it to rain or moisture.

### Intended use

Intended use of the ew 300 G3 series devices includes:

- having read these instructions especially the chapter “Important safety instructions”,
- using the devices within the operating conditions and limitations described in this instruction manual.

“Improper use” means using the devices other than as described in these instructions, or under operating conditions which differ from those described herein.

## The SK 300 G3 bodypack transmitter

The SK 300 G3 bodypack transmitter is part of the evolution wireless series generation 3 (ew G3). With this series, Sennheiser offers high-quality state-of-the-art RF transmission systems with a high level of operational reliability and ease of use. Transmitters and receivers permit wireless transmission with studio-quality sound.

Features of the evolution wireless 300 G3 series:

- Optimized PLL synthesizer and microprocessor technology
- **HDX** noise reduction system
- Pilot tone squelch control
- True diversity technology
- Switching bandwidth of 42 MHz
- Increased immunity to intermodulation and interferences in multi-channel operation

### The frequency bank system

Please note: Frequency usage is different for each country. Your Sennheiser partner will have all the necessary details on the available legal frequencies for your area.

The bodypack transmitter is available in 6 UHF frequency ranges with 1,680 transmission frequencies per frequency range:

Range A:	516 – 558 MHz	Range C:	734 – 776 MHz
Range G:	566 – 608 MHz	Range D:	780 – 822 MHz
Range B:	626 – 668 MHz	Range E:	823 – 865 MHz

Each frequency range (A–E, G) offers 26 frequency banks with up to 24 channels each:

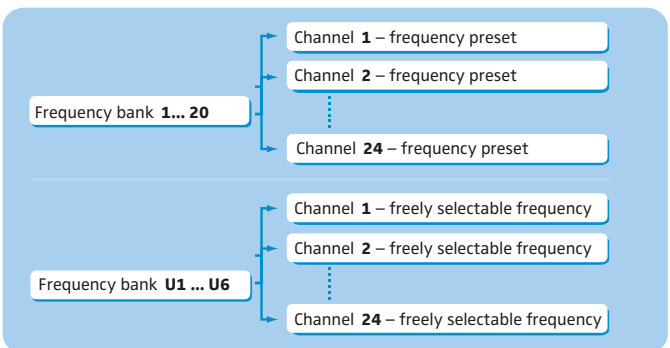

Each of the channels in the frequency banks “1” to “20” has been factory-preset to a fixed transmission frequency (frequency preset).

The factory-preset frequencies within one frequency bank are intermodulation-free. These frequencies cannot be changed.

For an overview of the frequency presets, please refer to the supplied frequency information sheet. Updated versions of the frequency information sheet can be downloaded from the SK 300 G3 product page on our website at [www.sennheiser.com](http://www.sennheiser.com).

The frequency banks “U1” to “U6” allow you to freely select and store transmission frequencies. It might be that these transmission frequencies are **not** intermodulation-free.

## Areas of application



The bodypack transmitter can be combined with the EM 300 G3 rack-mount receiver.

The EM 300 G3 rack-mount receiver is available in the same UHF frequency ranges and is equipped with the same frequency bank system. This has the advantage that

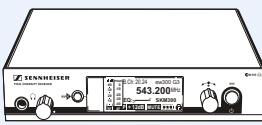
- a transmission system is ready for immediate use after switch-on,
- several transmission systems can be operated simultaneously on the preset frequencies without causing intermodulation interference.

Transmitter	Receiver	Combinable with
SK 300 G3 	EM 300 G3 	<ul style="list-style-type: none"> <li>• Clip-on microphones: ME 2, ME 4</li> <li>• Headmics: ME 3</li> <li>• Line cables: CI 2</li> </ul>

Overview of the microphones and line cables:

Microphone/line cable	Type	Pick-up pattern
ME 2 clip-on microphone	pre-polarized condenser microphone	 omni
ME 4 clip-on microphone		 cardioid
ME 3 headmic		 cardioid
CI 2 line cable	—	—

## Delivery includes

The packaging contains the following items:

- 1 SK 300 G3 bodypack transmitter
- 2 AA size batteries, 1.5 V
- 1 instruction manual
- 1 frequency information sheet

## Product overview

### Overview of the SK 300 bodypack transmitter

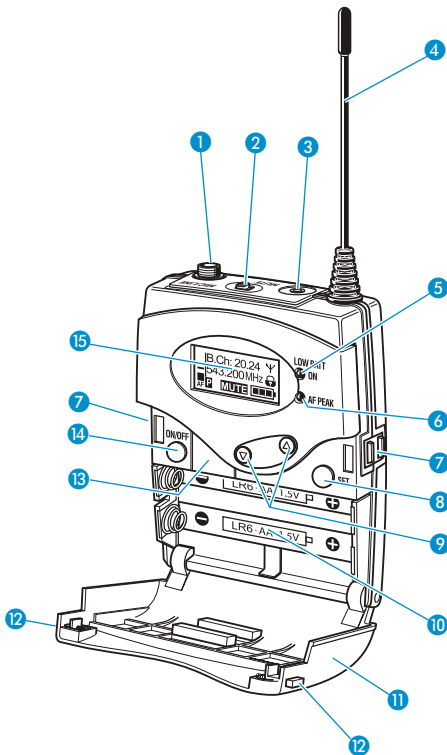

- 1 Microphone/instrument input (**MIC/LINE**), 3.5 mm jack socket, lockable
- 2 **MUTE** switch
- 3 Socket for connection of RMS 1 external mute switch, 2.5 mm jack socket
- 4 Antenna
- 5 Operation and battery status indicator, red LED (lit = **ON**/flashing = **LOW BAT**)
- 6 Audio overmodulation indicator, yellow LED (lit = **AF PEAK**)
- 7 Charging contacts
- 8 **SET** button
- 9 ▲/▼ rocker button (**UP/DOWN**)
- 10 Battery compartment
- 11 Battery compartment cover
- 12 Battery compartment catches
- 13 Infra-red interface
- 14 **ON/OFF** button (serves as the ESC (cancel) key in the operating menu)
- 15 Display panel, backlit in orange





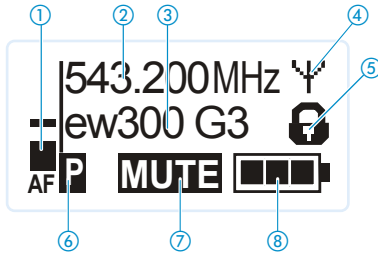

## Overview of the displays

After switch-on, the bodypack transmitter displays the standard display "Frequency/Name". For further illustrations and examples of the different standard displays, refer to page 13.

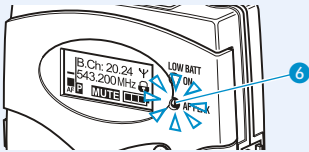
The display backlighting is automatically reduced after approx. 20 seconds.

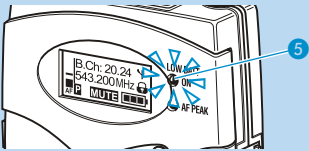

Display	Meaning
① Audio level "AF"	<p>Modulation of the bodypack transmitter with peak hold function</p> <p>When the transmitter's audio input level is excessively high, the "AF" display shows full deflection and, in addition, the yellow AF PEAK LED ⑥ lights up:</p> 
② Frequency	Current transmission frequency
③ Name	Freely selectable name of the bodypack transmitter
④ Transmission icon	RF signal is being transmitted
⑤ Lock mode icon	Lock mode is activated
⑥ "P" (Pilot)	Pilot tone transmission is activated
⑦ "MUTE"	Microphone or line input is muted
⑧ Battery status	<p>Charge status:</p> <ul style="list-style-type: none"> <li> approx. 100%</li> <li> approx. 70%</li> <li> approx. 30%</li> <li> charge status is critical, the red LOW BATT LED ⑤ is flashing:</li> </ul> 

## Putting the bodypack transmitter into operation

### Inserting the batteries/accupack

For powering the bodypack transmitter, you can either use two 1.5 V AA size batteries or the rechargeable Sennheiser BA 2015 accupack.

- ▶ Push the two catches **12** in the direction of the arrows and open the battery compartment cover **11**.

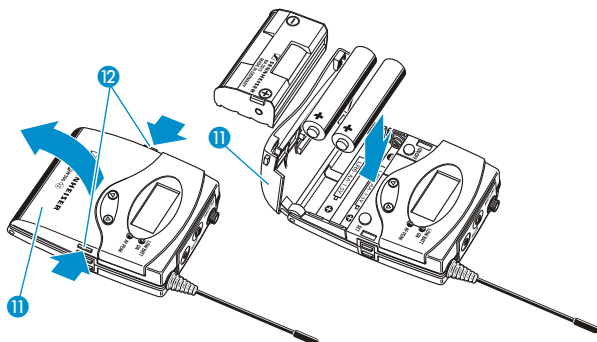

- ▶ Insert the two batteries or the accupack as shown above. Observe correct polarity when inserting the batteries/accupack.
- ▶ Close the battery compartment. The battery compartment cover **11** locks into place with an audible click.

### Charging the accupack

To charge the BA 2015 accupack:

- ▶ Insert the bodypack transmitter into the L 2015 charger (optional accessory).



The L 2015 charger can only charge the combination BA 2015 accupack/bodypack transmitter. Standard batteries (primary cells) or individual rechargeable battery cells cannot be charged.

### Connecting the microphone cable/line cable

The audio input is designed for the connection of both condenser microphones and other audio sources. DC powering of the condenser microphones is via the audio input (3.5 mm jack socket **MIC/LINE 1**).

- ▶ Use one of the recommended Sennheiser microphones or the optional CL 2 line cable.
- ▶ Connect the 3.5 mm jack plug **16** from the Sennheiser microphone or line cable to the 3.5 mm jack socket **MIC/LINE 1**.

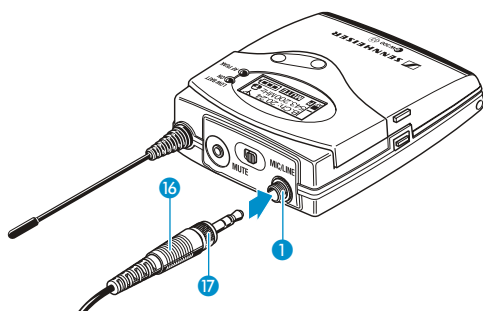

- ▶ Lock the 3.5 mm jack plug by screwing down the coupling ring **17** of the cable.
- ▶ Via the operating menu, adjust the sensitivity of the microphone/line input (see page 17).

## Attaching and positioning the microphones

### ME 2

- ▶ Use the microphone clip 18 to attach the microphone to clothing (e.g. tie, lapel).
- ▶ Attach the ME 2 microphone as close as possible to the sound source.



The ME 2 clip-on microphone has an omni-directional pick-up pattern. It is therefore not necessary to position it precisely.

### ME 3

- ▶ Adjust the ME 3 headmic so that a comfortable and secure fit is ensured.

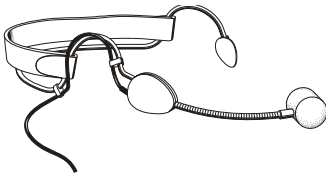

The ME 3 headmic has a cardioid pick-up pattern.

- ▶ Position the microphone so that its sound inlet is directed towards the sound source (e.g. mouth).

### ME 4

- ▶ Use the microphone clip 18 to attach the microphone to clothing (e.g. tie, lapel).

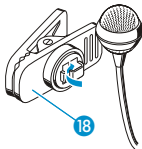

The ME 4 clip-on microphone has a cardioid pick-up pattern.

- ▶ Position the ME 4 so that its sound inlet is directed towards the sound source (e.g. mouth).

## Attaching the bodypack transmitter to clothing

You can use the belt clip 19 to attach the bodypack transmitter to clothing (e.g. belt, waistband).

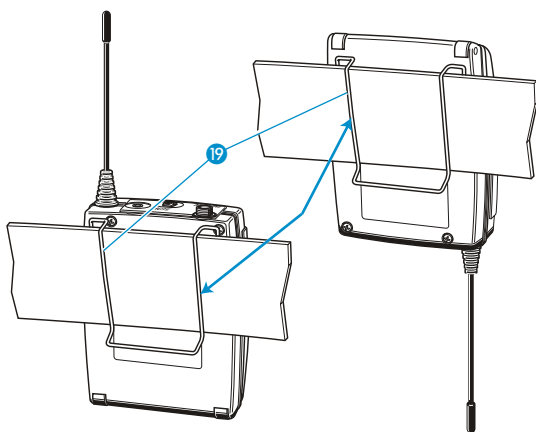

The belt clip is detachable so that you can also attach the transmitter with the antenna pointing downwards. To do so, withdraw the belt clip 19 from its fixing points and attach it the other way round.

The belt clip 19 is secured so that it cannot slide out of its fixing points accidentally.

To detach the belt clip:

- ▶ Lift one side of the belt clip as shown.
- ▶ Press down the belt clip at one fixing point and pull it out of the transmitter housing.
- ▶ Repeat for the other side.

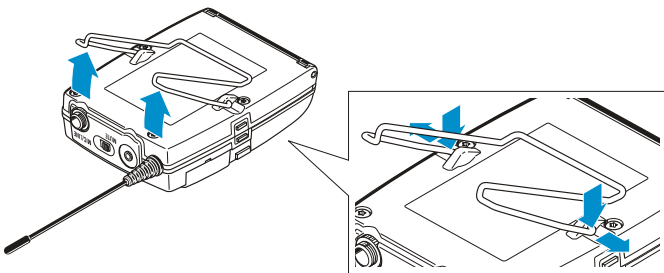

## Using the bodypack transmitter

To establish a transmission link, proceed as follows:

1. Switch the receiver on (see the instruction manual of the receiver).
2. Switch the bodypack transmitter on (see below).  
The transmission link is established and the display backlighting of the receiver changes from red to orange.

### Switching the bodypack transmitter on/off

- ▶ Push the two catches **12** and open the battery compartment cover **11**.

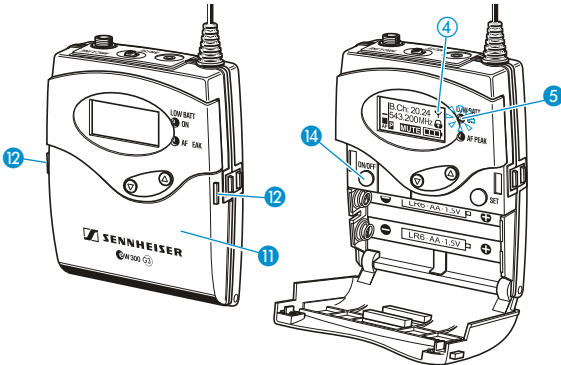

To switch the bodypack transmitter **on** (online operation):

- ON/OFF** ▶ Briefly press the **ON/OFF** button **14**.  
The bodypack transmitter transmits an RF signal. The standard display "Frequency/Name" appears on the display panel. The red **ON** LED **5** lights up and the transmission icon **4** is displayed.



You can switch the bodypack transmitter on and deactivate the RF signal on switch-on. For more information, see below.

To switch the bodypack transmitter **off**:

- ON/OFF** ▶ Press the **ON/OFF** button **14** until "OFF" appears on the display panel.  
The red **ON** LED **5** goes off and the display panel turns off.



When in the operating menu, pressing the **ON/OFF** button **14** will cancel your entry (ESC function) and return you to the current standard display.

To switch the bodypack transmitter **on** and to **deactivate the RF signal on switch-on** (offline operation):

- ON/OFF** ▶ Press the **ON/OFF** button until "RF Mute On?" appears on the display panel.
- SET** ▶ Press the **SET** button.  
The transmission frequency is displayed but the bodypack transmitter does not transmit an RF signal. The transmission icon **4** is not displayed.



Use this function to save battery power or to prepare a bodypack transmitter for use during live operation without causing interference to existing transmission links.

To activate the RF signal:

ON/OFF



- ▶ Briefly press the ON/OFF button.  
"RF Mute Off" appears on the display panel.

SET



- ▶ Press the SET button.  
The transmission icon ④ is displayed again.

## Deactivating the lock mode temporarily

You can activate or deactivate the automatic lock mode via the "Auto Lock" menu item (see page 18). If the lock mode is activated, you have to temporarily deactivate it in order to be able to operate the bodypack transmitter:



- ▶ Press the rocker button.  
"Unlock?" appears on the display panel.

SET



- ▶ Press the SET button.  
The lock mode is temporarily deactivated:

### When you are in the operating menu

The lock mode is deactivated as long as you are in the operating menu.

### When one of the standard displays is shown

The lock mode is automatically activated after 10 seconds.

Prior to this, the lock mode icon ⑤ flashes, indicating that the lock mode is being activated.



## Muting the audio signal or deactivating the RF signal

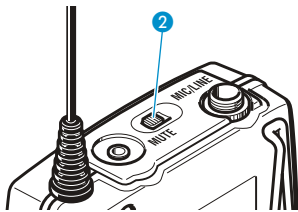

The MUTE switch ② allows you to mute the audio signal or to deactivate the RF signal. Via the "Mute Mode" menu item, you can set the desired function of the MUTE switch ② (see page 20):

Setting	Slide the MUTE ② switch ...	Function
"AF On/Off"	... to the left (position MUTE)	Mutes the audio signal
	... to the right	Unmutes the audio signal
"RF On/Off"	... to the left (position MUTE)	Deactivates the RF signal (offline operation)
	... to the right	Activates the RF signal (online operation)
"Disabled"	... to the left (position MUTE)	None

The "Push to mute" and "Push to talk" menu items are only available in conjunction with the RMS 1 external mute switch (optional accessory, see also page 20).

- ▶ From the "Mute Mode" menu item, select the desired setting (see page 20).
- ▶ Exit the operating menu.

- ▶ Slide the **MUTE** switch ② to the left, to the position **MUTE**.  
The bodypack transmitter reacts as indicated in the table.

The current state of the muting function or the RF signal is displayed on the display panel of the bodypack transmitter. An additional display appears on the receiver's display panel when the pilot tone function is activated on both bodypack transmitter and receiver and, in addition, this display has been activated via the "Warnings" menu item on the receiver (see the instruction manual of the receiver).

#### Audio signal is muted

Transmitter's display panel:	"MUTE" ⑦ is displayed
Receiver's display panel:	"TX Mute" is displayed*

\* only when activated on the receiver (see above)

#### Audio signal is activated (muting is deactivated)

Transmitter's display panel:	"MUTE" ⑦ is not displayed
Receiver's display panel:	"TX Mute" is not displayed

#### RF signal is deactivated

Transmitter's display panel:	Transmission icon ④ is not displayed
Receiver's display panel:	"RF Mute" is displayed*

\* only when activated on the receiver (see above)

#### RF signal is activated

Transmitter's display panel:	Transmission icon ④ is displayed
Receiver's display panel:	"RF Mute" is not displayed



You can also deactivate the RF signal on switch-on. For more information, refer to the chapter "Switching the bodypack transmitter on/off" on page 11.

Using the **ON/OFF** button, you can also activate/deactivate the RF signal during operation. To do so, briefly press the **ON/OFF** button and proceed as described on page 11.



## Selecting a standard display

- ▼▲ ▶ Press the rocker button to select a standard display:

Contents of the display	Selectable standard display
	"Frequency/Name"
	"Channel/Frequency"
	"Channel/Name"

## Using the operating menu

### The buttons

Button	Function of the button
Press the ON/OFF button 	<ul style="list-style-type: none"> <li>Switches the bodypack transmitter on and off</li> <li> Cancels the entry and returns to the current standard display (ESC function)</li> <li> Deactivates the RF signal (special function, see page 12)</li> </ul>
Press the SET button 	<ul style="list-style-type: none"> <li>Changes from the current standard display to the operating menu</li> <li> Calls up a menu item</li> <li> Enters a submenu</li> <li> Stores the settings and returns to the operating menu</li> </ul>
Press the rocker button 	<ul style="list-style-type: none"> <li>Selects a standard display</li> <li> Changes to the next/previous menu item</li> <li> Changes the setting of a menu item</li> </ul>

### Overview of the operating menu

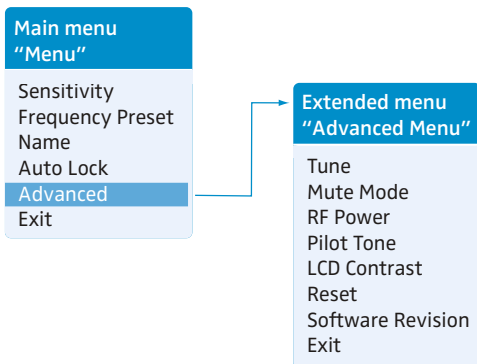

Display	Function of the menu item
Main menu "Menu"	
Sensitivity	Adjusts the sensitivity "AF" (see page 17)
Frequency Preset	Changes the frequency bank and the channel (see page 17)
Name*	Enters the transmitter name (see page 18)
Auto Lock	Activates/deactivates the automatic lock mode (see page 18)
Advanced	Calls up the extended menu "Advanced Menu" (see page 19)
Exit	Exits the operating menu and returns to the current standard display
Extended menu "Advanced Menu"	
Tune	Sets the transmission frequencies for the frequency banks "U1" to "U6" (see page 19) Special function: Sets a channel and a transmission frequency for the frequency banks "U1" to "U6" (see page 19)
Mute Mode	Sets the mode for the MUTE switch (see page 20)
RF Power	Adjusts the transmission power (see page 21)
Pilot Tone	Activates/deactivates the pilot tone transmission (see page 21)



Display	Function of the menu item
LCD Contrast	Adjusts the contrast of the display panel (see page 21)
Reset	Resets the bodypack transmitter (see page 21)
Software Revision	Displays the current software revision (see page 21)
Exit	Exits the extended menu "Advanced Menu" and returns to the main menu

## Working with the operating menu



If the lock mode is activated, you have to deactivate it in order to be able to work with the operating menu (see page 12).

By way of example of the "Sensitivity" menu, this section describes how to use the operating menu.

### Changing from the current standard display to the operating menu



- ▶ Press the SET button.  
The current standard display is replaced by the main menu.  
The last selected menu item is displayed.

### Selecting a menu item

- ▼▲ ▶ Press the rocker button to change to the "Sensitivity" menu item.  
The current setting of the selected menu item is displayed:

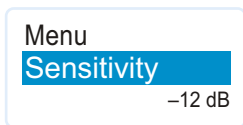

### Changing and storing settings

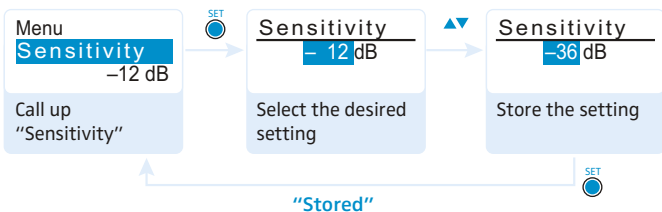

- SET ▶ Press the SET button to call up the menu item.
- ▼▲ ▶ Press the rocker button to adjust the input sensitivity.
- SET ▶ Press the SET button to store the setting.

The rocker button features a "fast search" function:

Rocker button	Display
Press the UP button	jumps to the previous menu item/setting
Press the DOWN button	jumps to the next menu item/setting
Hold the button pressed	cycles continuously

### Canceling an entry

ON/OFF



- ▶ Press the **ON/OFF** button to cancel the entry.  
The current standard display appears on the display panel.

To return to the last edited menu item:

SET



- ▶ Press the **SET** button so many times until the last edited menu item appears.

### Exiting a menu item

To return to the next higher menu level:

- ▼▲ ▶ Change to the “**Exit**” menu item.

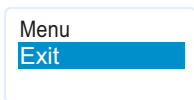

SET



- ▶ Confirm your selection.  
You return to the next higher menu level.

To directly return to the current standard display:

ON/OFF



- ▶ Press the **ON/OFF** button.

## Adjusting settings via the operating menu



Make use of the possibility to adjust settings via the operating menu of your receiver and to transfer these settings to the body-pack transmitter. For more information, refer to the instruction manual of the receiver. The relevant information is marked with the sync icon.

For more detailed information on the operating menu, visit the SK 300 G3 product page at [www.sennheiser.com](http://www.sennheiser.com).

### The main menu "Menu"

#### Adjusting the input sensitivity – "Sensitivity"

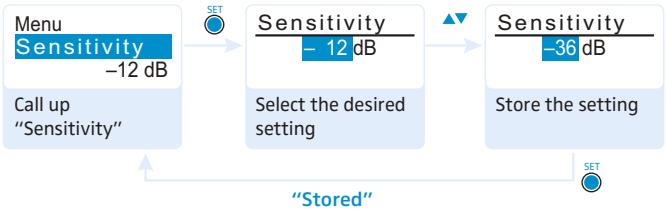

Adjustment range: 0 to -60 dB, adjustable in steps of 3 dB

The transmitter's audio level display "AF" ① always indicates the audio level, even if the bodypack transmitter is muted, e.g. allowing you to check the adjusted sensitivity before live operation.

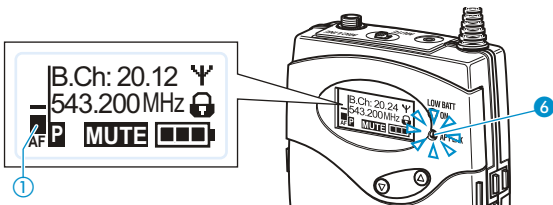

Input sensitivity adjusted...	Effect/display
... too high	Close talking distances, speakers with loud voices or loud music passages cause overmodulation in the transmission link. The yellow AF PEAK LED ⑥ lights up. The audio level display "AF" ① shows full deflection for the duration of the overmodulation.
... correctly	The audio level display "AF" ① shows full deflection only during the loudest passages.
... too low	The transmission link is undermodulated. This results in a signal with high background noise.

The following figures are a guide to the best settings:

Transmission situation	Sensitivity setting
Loud music/vocals	-30 to -21 dB
Presentations	-21 to 0 dB

#### Selecting the frequency bank and the channel manually – "Frequency Preset"

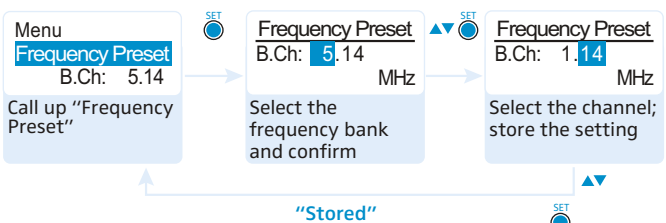

When you are in the "Frequency Preset" menu item, the RF signal is deactivated.

Overview of the frequency banks and channels:

Frequency bank	Channels	Type
"1" to "20"	up to 24 per frequency bank	System bank: frequencies are factory-preset
"U1" to "U6"	up to 24 per frequency bank	User bank: frequencies are freely selectable

When setting up multi-channel systems, please observe the following:

Only the factory-preset frequencies within one frequency bank are intermodulation-free (see page 22). Bodypack transmitter and receiver of a transmission link have to be set to the same frequency. It is vital to observe the notes on frequency selection on page 22.

### Entering a name – "Name"

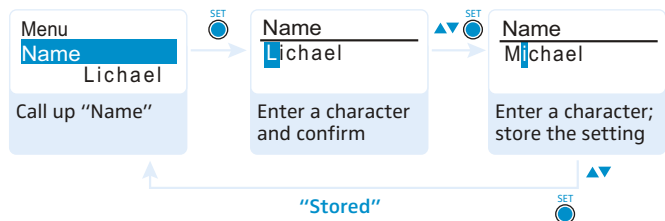

Via the "Name" menu, you can enter a freely selectable name (e.g. the name of the performer) for the bodypack transmitter.

The name can be displayed on the standard displays "Frequency/Name" and "Channel/Name". The name can consist of up to 8 characters such as:

- letters (without pronunciation marks),
- numbers from 0 to 9,
- special characters and spaces.

To enter a name, proceed as follows:

- ▼▲ ▶ Press the rocker button to select a character.
- SET ▶ Press the SET button to change to the next segment/character or to store the complete entry.

### Activating/deactivating the automatic lock mode – "Auto Lock"

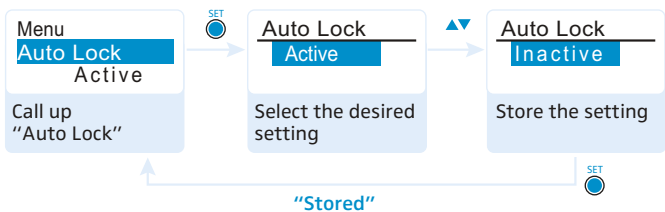

The lock mode prevents that the bodypack transmitter is accidentally switched off or programmed during operation. The lock mode icon (5) on the current standard display indicates that the lock mode is activated.

- ▼▲ ▶ Press the rocker button to select the desired setting.

For information on how to use the lock mode, refer to page 12.

## The extended menu “Advanced Menu”

### Setting transmission frequencies and frequency banks – “Tune”

When you have selected one of the system banks and then select the “Tune” menu, the bodypack transmitter automatically switches to channel 1 of the frequency bank “U1”. In this case, “U1.1” briefly appears on the display panel. Upon delivery, the channels of the frequency banks “U1” to “U6” are not assigned a transmission frequency.

When you are in the “Tune” menu item, the RF signal is deactivated. Via the “Tune” menu item, you can set a transmission frequency to be stored in the current channel **or** you can select a different channel in one of the frequency banks “U1” to “U6” and assign this channel a transmission frequency. It is vital to observe the notes on frequency selection on page 22.

### Setting a transmission frequency for the current channel

- ▶ Press the rocker button until the “Tune” menu item appears.



- ▶ Press the SET button.  
The frequency selection appears.

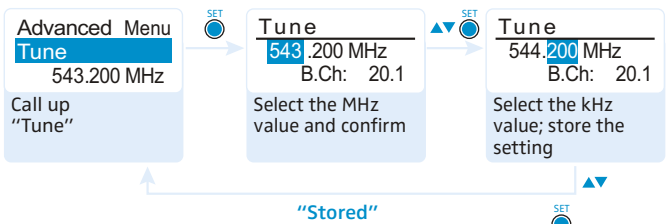

- ▶ Set the desired frequency.



- ▶ Press the SET button.  
Your settings are stored.  
You are back to the operating menu.

### Selecting a channel and assigning this channel a frequency

- ▶ Press the rocker button until the “Tune” menu item appears.



- ▶ Press the SET button until the frequency bank selection appears.

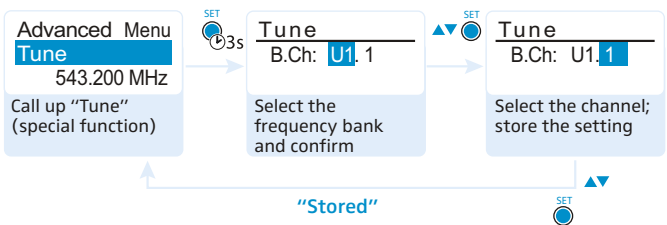

- ▶ Set the desired frequency bank and the desired channel.



- ▶ Press the SET button.  
The frequency selection appears.

- ▶ Set the desired frequency.

### Setting the mode for the MUTE switch and the RMS 1 external mute switch – “Mute Mode”

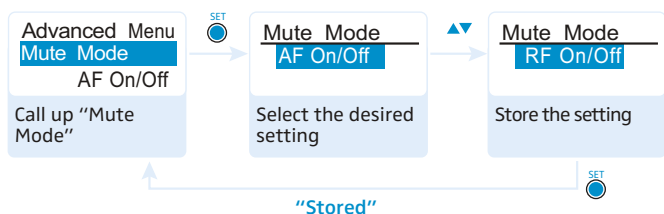

The “Push to mute” and “Push to talk” menu items are only available in conjunction with the RMS 1 external mute switch.

Mode	Switch	Function
“AF On/Off”	MUTE switch	If set to position MUTE, the audio signal is muted.
	RMS 1 external mute switch*	If you press the MIC button of the RMS 1*: The audio signal is muted. If you press the MIC button of the RMS 1* again: The muting is canceled.
“RF On/Off”	MUTE switch	If set to position MUTE, the RF signal is deactivated.
	RMS 1 external mute switch*	If you press the MIC button of the RMS 1*: The radio signal is deactivated. If you press the MIC button of the RMS 1* again: The RF signal is reactivated.
“Push To Mute”	RMS 1 external mute switch*	The audio signal is muted as long as you press the MIC button of the RMS 1*.
“Push To Talk”**	RMS 1 external mute switch*	The audio signal is activated as long as you press the MIC button of the RMS 1*.
“Disabled”	MUTE switch or RMS 1 external mute switch*	The function is deactivated.

\* optional accessory

\*\* If you select “Push To Talk”, the bodypack transmitter will be muted until the MIC button is pressed.



If you connect the RMS 1 external mute switch, you can only set the muting via the RMS 1.

The function of the MUTE switch is deactivated during this time.

For information on the use of the MUTE switch, refer to page 12.

## Adjusting the transmission power – “RF Power”

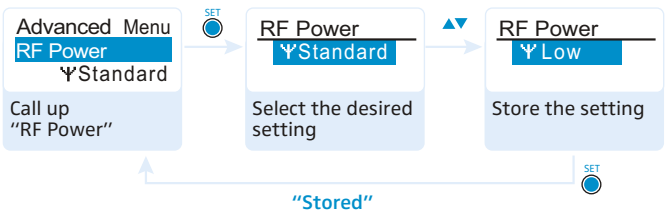

Via the “RF Power” menu item, you can adjust the transmission power in two steps. It is vital to observe the notes on the supplied frequency information sheet!

## Activating/deactivating the pilot tone transmission – “Pilot Tone”

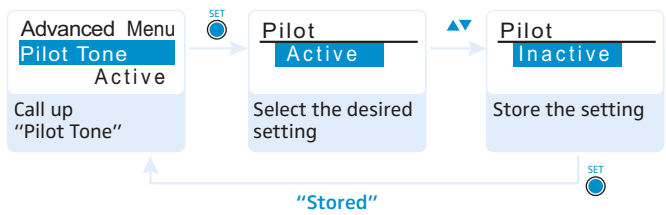

The bodypack transmitter adds an inaudible pilot tone to the audio signal. The receiver detects and evaluates the pilot tone, and is thus able to identify the signal of the matching transmitter and mute all others. The pilot tone supports the receiver’s squelch function.

Devices of the ew 300 G1 series (generation 1) do not support the pilot tone function. Therefore, please observe the following when combining a bodypack transmitter or receiver of the ew 300 G3 series (generation 3) with devices from an earlier evolution wireless generation:

Transmitter	Receiver	Make sure to ...
ew G3/ew G2	ew G3/ew G2	... activate the pilot tone function on both bodypack transmitter and receiver.
ew G3	ew G1	... deactivate the pilot tone function on the ew 300 G3 bodypack transmitter.
ew G1	ew G3	... deactivate the pilot tone function on the ew 300 G3 receiver.

## Adjusting the contrast of the display panel – “LCD Contrast”

You can adjust the contrast of the display panel in 16 steps.

## Loading the factory-preset default settings – “Reset”

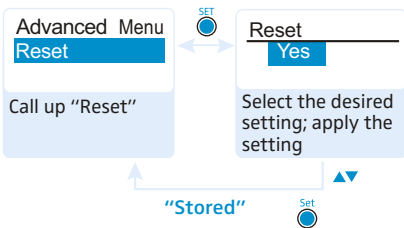

When resetting the bodypack transmitter, only the selected settings for the pilot tone and for the frequency banks “U1” to “U6” remain unchanged.

## Displaying the software revision – “Software Revision”

You can display the current software revision of the bodypack transmitter.

- ▶ For information on software updates, visit the SK 300 G3 product page at [www.sennheiser.com](http://www.sennheiser.com).

## Adjustment tips

### Synchronizing the bodypack transmitter with a receiver

When synchronizing the bodypack transmitter with a receiver, please observe the following:

- ▶ Only use a bodypack transmitter and a receiver from the same frequency range (see the type plate on the transmitter and the receiver).
- ▶ Make sure that the desired frequencies are listed in the enclosed frequency information sheet.
- ▶ Make sure that the desired frequencies are approved and legal in your country and, if necessary, apply for an operating license.

### Synchronizing the bodypack transmitter with the receiver – individual operation

Upon delivery, the bodypack transmitter and the receiver are synchronized with each other. However, if you cannot establish a transmission link between bodypack transmitter and receiver, you have to synchronize the channels of the devices.

For information on automatic synchronization of the bodypack transmitter with the receiver (individual operation), refer to the instruction manual of the receiver. This information is marked with the **sync** icon.

Alternatively, you can set the channel on the bodypack transmitter manually:

- ▶ Make sure that you set the bodypack transmitter to the same frequency bank and the same channel as the receiver (see page 17).

If you still cannot establish a transmission link, refer to the chapter “If a problem occurs ...” on page 23.

### Synchronizing bodypack transmitters with receivers – multi-channel operation

Combined with ew 300 G3 receivers, ew 300 G3 bodypack transmitters can form transmission links that can be used in multi-channel systems. In order to ensure an intermodulation-free transmission, use the same frequency bank for all transmission links.

For information on automatic synchronization of bodypack transmitters with receivers (multi-channel operation), refer to the instruction manual of your receiver. For more information on multi-channel operation, visit the SK 300 G3 product page at [www.sennheiser.com](http://www.sennheiser.com).

## Cleaning the bodypack transmitter

---

**CAUTION!** Liquids can damage the electronics of the bodypack transmitter!

Liquids entering the housing of the device can cause a short-circuit and damage the electronics.

- ▶ Keep all liquids away from the bodypack transmitter.
- 

- ▶ Use a slightly damp cloth to clean the bodypack transmitter from time to time. Do not use any solvents or cleansing agents.



## If a problem occurs ...

Problem	Possible cause	Possible solution
Bodypack transmitter cannot be operated, "Locked" appears on the display panel	Lock mode is activated	Deactivate the lock mode (see page 12).
No operation indication	Batteries are flat or accupack is flat	Replace the batteries or recharge the accupack (see page 8).
No RF signal at the receiver	Bodypack transmitter and receiver are not on the same channel	Set the bodypack transmitter to the same channel as the receiver. Synchronize the bodypack transmitter with the receiver.
	Bodypack transmitter is out of range	Check the squelch threshold setting on the receiver. Reduce the distance between bodypack transmitter and receiving antenna.
	RF signal is deactivated ("RF Mute")	Activate the RF signal (see page 12).
RF signal available, no audio signal, "MUTE" appears on the display panel	Bodypack transmitter is muted (MUTE)	Cancel the muting (see page 12).
	Receiver's squelch threshold is adjusted too high	Reduce the squelch threshold setting on the receiver.
	Bodypack transmitter doesn't transmit a pilot tone	Activate or deactivate the pilot tone transmission (see page 21).
Audio signal has a high level of background noise / audio signal is distorted	Bodypack transmitter's sensitivity is adjusted too low/too high	Adjust the input sensitivity (see page 17).

If a problem occurs that is not listed in the above table or if the problem cannot be solved with the proposed solutions, please contact your local Sennheiser partner for assistance.

To find a Sennheiser partner in your country, search at [www.sennheiser.com](http://www.sennheiser.com) under "Service & Support".

## Specifications

### RF characteristics

Modulation	wideband FM
Frequency ranges	516–558, 566–608, 626–668, 734–776, 780–822, 823–865 MHz (A to E, G, see page 3)
Transmission frequencies	1,680 frequencies, tuneable in steps of 25 kHz
	20 frequency banks, each with up to 24 factory-preset channels
	6 frequency banks with up to 24 user programmable channels
Switching bandwidth	42 MHz
Nominal/peak deviation	$\pm 24$ kHz/ $\pm 48$ kHz
Frequency stability	$\leq \pm 15$ ppm
RF output power at 50 $\Omega$	typ. 10 mW (low) typ. 30 mW (standard)
Pilot tone squelch	can be switched off

### AF characteristics

Compander system	Sennheiser <a href="#">HDX</a>
AF frequency response	microphone: 80–18,000 Hz line: 25–18,000 Hz
Signal-to-noise ratio (1 mV, peak deviation)	$\geq 115$ dBA
THD	$\leq 0.9\%$
Max. input voltage	3 V <sub>rms</sub>
Input impedance	40 k $\Omega$ unbalanced/1 M $\Omega$
Adjustment range of input sensitivity	60 dB, adjustable in 3-dB steps

### Overall device

Temperature range	-10°C to +55°C
Power supply	2 AA size batteries, 1.5 V or BA 2015 accupack
Nominal voltage	2.4 V $\approx$
Power consumption	
at nominal voltage	typ. 180 mA (30 mW)
with switched-off transmitter	$\leq 5$ $\mu$ A
Operating time	typ. 8 hrs
Dimensions	approx. 82 x 64 x 24 mm
Weight (incl. batteries)	approx. 160 g

### In compliance with

Europe	EMC	EN 301489-1/-9
	Radio	EN 300422-1/-2
	Safety	EN 60065, EN 62311 (SAR)

Approved by

Canada

Industry Canada RSS 210

IC 2099A-G3SK

limited to 806 MHz

USA

FCC-Part 74 FCC-ID: DMO G3SK

limited to 698 MHz

Microphones

	ME 2	ME 3	ME 4
Microphone type	condenser	condenser	condenser
Sensitivity	20 mV/Pa	1.6 mV/Pa	40 mV/Pa
Pick-up pattern	omni-directional	cardioid	cardioid
Max. SPL	130 dB SPL	150 dB SPL	120 dB SPL

Connector assignment

3.5 mm jack plug

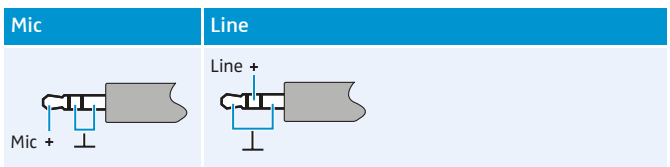

Polar diagrams and frequency response curves of the microphones

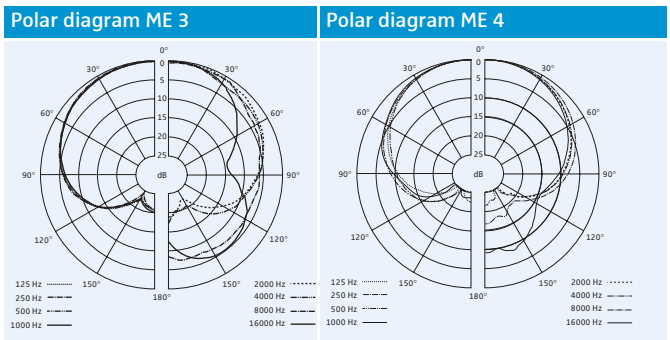

Frequency response curve ME 2

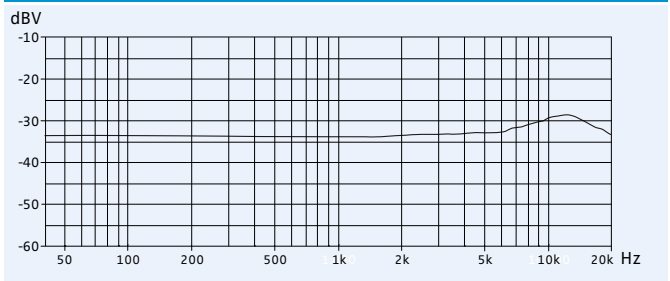

Frequency response curve ME 3

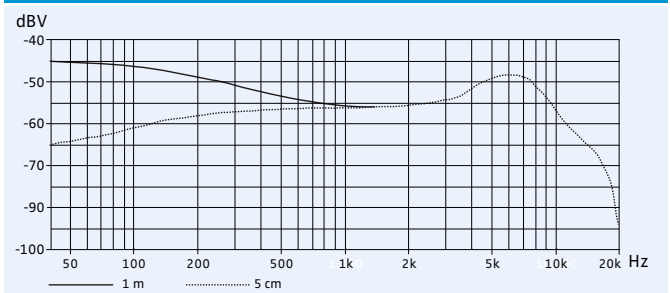

Frequency response curve ME 4

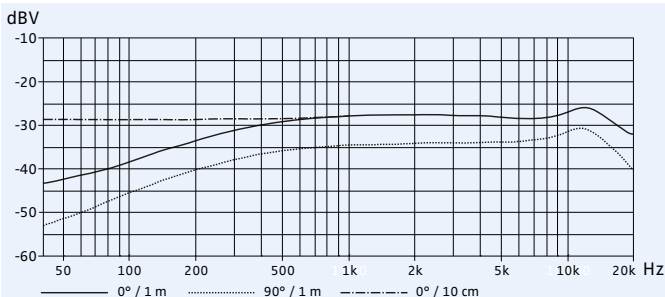

## Manufacturer Declarations

### Warranty

Sennheiser electronic GmbH & Co. KG gives a warranty of 24 months on this product.

For the current warranty conditions, please visit our web site at [www.sennheiser.com](http://www.sennheiser.com) or contact your Sennheiser partner.

### In compliance with the following requirements

- RoHS Directive (2002/95/EU)
- WEEE Directive (2002/96/EU)



Please dispose of the bodypack transmitter at the end of its operational lifetime by taking it to your local collection point or recycling center for such equipment.

- Battery Directive (2006/66/EU)



The supplied batteries or rechargeable batteries of the bodypack transmitter can be recycled. Please dispose of them as special waste or return them to your specialist dealer. In order to protect the environment, only dispose of exhausted batteries.

### CE Declaration of Conformity

- **CE 0682**
- R&TTE Directive (1999/5/EU), EMC Directive (2004/108/EU), Low Voltage Directive (2006/95/EU)  
The declarations are available at [www.sennheiser.com](http://www.sennheiser.com).  
Before putting the device into operation, please observe the respective country-specific regulations.

## Statements regarding FCC and Industry Canada

This device complies with Part 15 of the FCC Rules and with RSS-210 of Industry Canada. Operation is subject to the following two conditions: (1) this device may not cause harmful interference, and (2) this device must accept any interference received, including interference that may cause undesired operation.

This equipment has been tested and found to comply with the limits for a Class B digital device, pursuant to Part 15 of the FCC Rules. These limits are designed to provide reasonable protection against harmful interference in a residential installation. This equipment generates, uses and can radiate radio frequency energy and, if not installed and used in accordance with the instructions, may cause harmful interference to radio communications. However, there is no guarantee that interference will not occur in a particular installation. If this equipment does cause harmful interference to radio or television reception, which can be determined by turning the equipment off and on, the user is encouraged to try to correct the interference by one or more of the following measures:

- Reorient or relocate the receiving antenna.
- Increase the separation between the equipment and receiver.
- Connect the equipment into an outlet on a circuit different from that to which the receiver is connected.
- Consult the dealer or an experienced radio/TV technician for help.

This class B digital device complies with the Canadian ICES-003.

Changes or modifications made to this equipment not expressly approved by Sennheiser electronic Corp. may void the FCC authorization to operate this equipment.

Before putting the device into operation, please observe the respective country-specific regulations!





Sennheiser electronic GmbH & Co. KG  
Am Labor 1, 30900 Wedemark, Germany  
[www.sennheiser.com](http://www.sennheiser.com)

Printed in Germany  
Publ. 01/09  
529670/A01